



**W83194BR-B**  
**Stepless Clock Gen. For INTEL**  
**Brookdale Chipset**

Date: 02/25/2003      Revision: 2.0

## W83194BR-B Data Sheet Revision History

NO.	Pages	Dates	Version	Web Version	Main Contents
1	n.a.			n.a.	All of the versions before 0.50 are for internal use.
2	n.a.	4/1/2002	1.0	1.0	Change version and version on web site to 1.0
3	11	10/1/2002	1.1	1.0	Modify ratio table of CPU, 3V66, and PCI clock selection.
4	All	02/20/2003	2.0	2.0	Update new form
5					
6					
7					
8					
9					
10					

Please note that all data and specifications are subject to change without notice. All the trademarks of products and companies mentioned in this data sheet belong to their respective owners.

### LIFE SUPPORT APPLICATIONS

These products are not designed for use in life support appliances, devices, or systems where malfunction of these products can reasonably be expected to result in personal injury. Winbond customers using or selling these products for use in such applications do so at their own risk and agree to fully indemnify Winbond for any damages resulting from such improper use or sales.

# STEPLESS CLOCK FOR INTEL BROOKDALE CHIPSET

## TABLE OF CONTENT

<b>1. GENERAL DESCRIPTION .....</b>	<b>1</b>
<b>2. PRODUCT FEATURES .....</b>	<b>1</b>
<b>3. PIN CONFIGURATION .....</b>	<b>2</b>
<b>4. BLOCK DIAGRAM .....</b>	<b>2</b>
<b>5. PIN DESCRIPTION.....</b>	<b>3</b>
5.1 CRYSTAL I/O .....	3
5.2 CPU, 3V66, AND PCI CLOCK OUTPUTS.....	3
5.3 I <sup>2</sup> C CONTROL INTERFACE.....	4
5.4 FIXED FREQUENCY OUTPUTS.....	5
5.5 POWER PINS.....	5
<b>6. FREQUENCY SELECTION BY HARDWARE OR SOFTWARE .....</b>	<b>6</b>
<b>7. I<sup>2</sup>C CONTROL AND STATUS REGISTERS.....</b>	<b>7</b>
7.1 REGISTER 1: FREQUENCY SELECT REGISTER (DEFAULT = 0).....	7
7.2 REGISTER 2: CPU CLOCK REGISTER (1 = ENABLE, 0 = STOPPED) .....	7
7.3 REGISTER 3: PCI CLOCK REGISTER (1 = ENABLE, 0 = STOPPED) .....	7
7.4 REGISTER 4: PCI, 48MHZ CLOCK REGISTER (1 = ENABLE, 0 = STOPPED).....	8
7.5 REGISTER 5: 3V66 CONTROL REGISTER (1 = ENABLE, 0 = STOPPED) .....	8
7.6 REGISTER 6: WATCHDOG CONTROL REGISTER .....	8
7.7 REGISTER 7: WATCHDOG TIMER REGISTER .....	9
7.8 REGISTER 8: M/N PROGRAM REGISTER.....	9
7.9 REGISTER 9: M/N PROGRAM REGISTER.....	9
7.10 REGISTER 10: SPREAD SPECTRUM PROGRAMMING REGISTER .....	10
7.11 REGISTER 11: DIVISOR AND STEP-LESS ENABLE AND SKEW CONTROL REGISTER.....	10
7.12 REGISTER 12: WINBOND CHIP ID REGISTER (READ ONLY).....	11
7.13 REGISTER 13: WINBOND CHIP ID REGISTER (READ ONLY).....	11
7.14 REGISTER 81: WINBOND TEST REGISTER I .....	11
7.15 REGISTER 82: WINBOND TEST REGISTER II .....	11
<b>8. ACCESS INTERFACE.....</b>	<b>12</b>
8.1 BLOCK WRITE PROTOCOL.....	12
8.2 BLOCK READ PROTOCOL .....	12
8.3 BYTE WRITE PROTOCOL.....	12
8.4 BYTE READ PROTOCOL .....	12
<b>9. SPECIFICATIONS .....</b>	<b>13</b>
9.1 ABSOLUTE MAXIMUM RATINGS.....	13

---

**STEPLESS CLOCK FOR INTEL BROOKDALE CHIPSET**

**10. ORDERING INFORMATION..... 13**

**11. HOW TO READ THE TOP MARKING..... 14**

**12. PACKAGE DRAWING AND DIMENSIONS ..... 15**

## STEPLESS CLOCK FOR INTEL BROOKDALE CHIPSET

### 1. GENERAL DESCRIPTION

The W83194BR-B is a Clock Synthesizer for Intel Brookdale 845 chipset. W83194BR-B provides all clocks required for high-speed microprocessor and provides step-less frequency programming and 32 different frequencies of CPU, PCI, and 3V66 clocks setting. All clocks are externally selectable with smooth transitions.

The W83194BR-B provides I<sup>2</sup>C serial bus interface to program the registers to enable or disable each clock outputs and provides -0.5% and +/-0.25% center type spread spectrum or programmable S.S.T. scale to reduce EMI.

The W83194BR-B also has watch dog timer and reset output pin to support auto-reset when systems hanging caused by improper frequency setting.

The W83194BR-B accepts a 14.318 MHz reference crystal as its input and runs on a 3.3V supply. High drive PCI CLOCK outputs typically provide greater than 1 V/ns slew rate into 30 pF loads. CPU CLOCK outputs typically provide better than 1 V/ns slew rate into 20 pF loads as maintaining 50± 5% duty cycle. The fixed frequency outputs as REF and 48 MHz provide better than 0.5V/ns slew rate.

### 2. PRODUCT FEATURES

- 3 pairs of CPU clock outputs
- 4 3V66 clock outputs
- 9 PCI synchronous clocks
- 2 48 MHz clock outputs for USB and DOT
- Skew from CPU to PCI clock 1 to 4 ns, center 2.6 ns
- Smooth frequency switch with selections from 66.6 to 200MHz
- Step-less frequency programming
- I<sup>2</sup>C 2-Wire serial interface and I<sup>2</sup>C read back
- -0.5% and +/- 0.25% center type spread spectrum
- Programmable S.S.T. scale to reduce EMI
- Programmable registers to enable/stop each output and select modes
- Watch Dog Timer and RESET# output pins
- 48-pin SSOP package

## STEPLESS CLOCK FOR INTEL BROOKDALE CHIPSET

### 3. PIN CONFIGURATION

VDDREF	1	●	48	REF <sup>^</sup> /FS2&
XIN	2		47	CPUCLKT0
XOUT	3		46	CPUCLKC0
GND	4		45	VDDCFU
FS0& /PCICLK_F1 <sup>^</sup>	5		44	CPUCLKT1
FS1& /PCICLK_F2 <sup>^</sup>	6		43	CPUCLKC1
VDDPCI	7		42	GND
GND	8		41	VDDCFU
ENWD* /PCICLK0 <sup>^</sup>	9		40	CPUCLKT2
PCICLK1	10		39	CPUCLKC2
PCICLK2	11		38	MULTISEL0*
PCICLK3	12		37	IREF
VDDPCI	13		36	GND
GND	14		35	48MHZ_USB /FS3&
PCICLK4	15		34	48MHZ_DOT
PCICLK5	16		33	AVDD48
PCICLK6	17		32	GND
VDD3V66	18		31	3V66_0 /VCH_CLK /FS4&
GND	19		30	VDD3V66
3V66_1	20		29	GND
3V66_2	21		28	SCLK*
3V66_3	22		27	SDATA*
RESET#	23		26	VTT_FWRGD /FD#*
VDDA	24		25	GND

#: Active low  
<sup>^</sup>: These outputs have 1.5 ~ 2X drive strength  
 \*: Internal pull up resistor 120K to VDD  
 &: Internal Pull-down resistor 120K to GND

### 4. BLOCK DIAGRAM

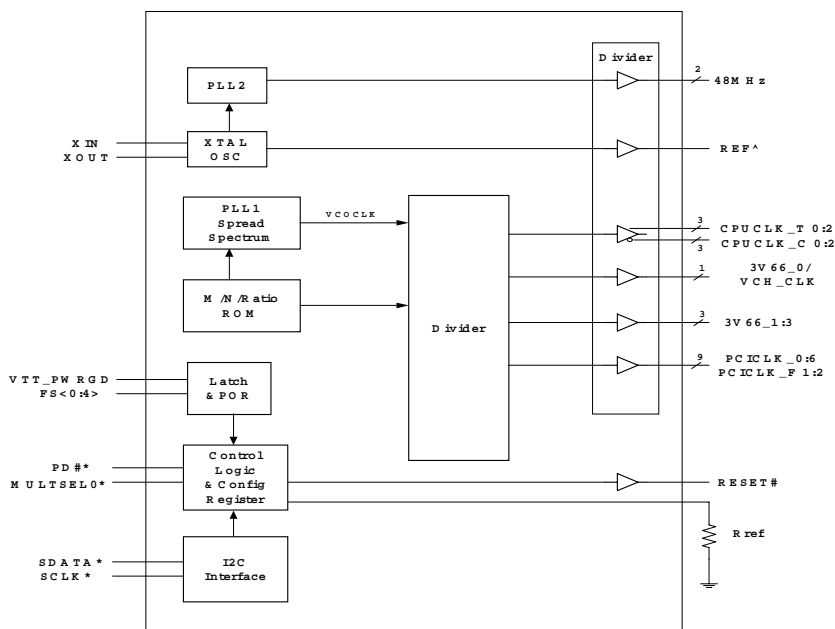

## STEPLESS CLOCK FOR INTEL BROOKDALE CHIPSET

### 5. PIN DESCRIPTION

Buffer type symbol	Description
IN	Input
IN <sub>td120k</sub>	Input pin and internal 120K pull down
OUT	Output
OD	Open Drain
I/O	Bi-directional Pin
I/OD	Bi-directional Pin, Open Drain
#	Active Low
*	Internal 120kΩ pull-up
&	Internal 120kΩ pull-down
^	1.5X~2X strength

#### 5.1 Crystal I/O

PIN	Pin Name	Type	Description
3	XIN	IN	Crystal input with internal loading capacitors (18pF) and feedback resistors.
4	XOUT	OUT	Crystal output at 14.318MHz nominally with internal loading capacitors (18pF).

#### 5.2 CPU, 3V66, and PCI Clock Outputs

PIN	Pin Name	Type	Description															
47, 46, 44, 43, 40, 39	CPUCLKT [0:2] CPUCLKC [0:2]	OUT	Low skew (< 250ps) differential clock outputs for host frequencies of CPU and chipset															
38	MULTISEL0*	IN	Power on trapping for different current reference. The reference current is referred for Pin 37 (IREF). This pin is latched during VTT_PWRGD. This pin is internal pull up 120K.															
37	IREF	IN	Deciding the reference current for the CPUCLK pairs. The pin was connected to the precision resistor tied to ground to decide the appropriate current. There are two modes to select different current via power on trapping the Pin 38 (MULTISEL0). The table is show as follows. <table border="1" data-bbox="738 1575 1544 1785"> <thead> <tr> <th>MULTISEL0</th> <th>Board Target Trace</th> <th>Reference R, Iref</th> <th>Output Current</th> <th>Ioh @ Z</th> </tr> </thead> <tbody> <tr> <td>0</td> <td>50 Ohms</td> <td>R=221 Iref=5.0mA</td> <td>Ioh=4*Iref</td> <td>1.0V @ 50</td> </tr> <tr> <td>1</td> <td>50 Ohms</td> <td>R=475 Iref=232mA</td> <td>Ioh=6*Iref</td> <td>0.7V @ 50</td> </tr> </tbody> </table>	MULTISEL0	Board Target Trace	Reference R, Iref	Output Current	Ioh @ Z	0	50 Ohms	R=221 Iref=5.0mA	Ioh=4*Iref	1.0V @ 50	1	50 Ohms	R=475 Iref=232mA	Ioh=6*Iref	0.7V @ 50
MULTISEL0	Board Target Trace	Reference R, Iref	Output Current	Ioh @ Z														
0	50 Ohms	R=221 Iref=5.0mA	Ioh=4*Iref	1.0V @ 50														
1	50 Ohms	R=475 Iref=232mA	Ioh=6*Iref	0.7V @ 50														
23	RESET#	OD	System reset signal when the watch dog is time out. This pin will generate 250mS when the watchdog timer is timeout.															

## STEPLESS CLOCK FOR INTEL BROOKDALE CHIPSET

26	VTT_PWRGD	IN	Power good input signal comes from ACPI with high active. This 3.3V input is level sensitive strobe used to determine FS [4:0] and MULTISEL0 input are valid and is ready to sample. This pin is high active.
	PD#*	IN	Power Down Function. This is internal 120K pull up. This is multi-function pin. When the VTT_PWRGD signal is asserted (this is, turns from a logical Low to high), the pin will be switched into the function of power down (PD#).
31	3V66_0	OUT	66MHz or 48MHz outputs selected by I2C register.
	VCH_CLK	OUT	
	FS4 <sup>&amp;</sup>	IN <sub>td120k</sub>	Latched input for FS4 at initial power up for H/W selecting the output frequency of CPU 3V66 and PCI clocks. This is internal 120K pull down.
5	PCICLK_F1 <sup>^</sup>	OUT	3.3V free running PCI clock during normal operation. This pin is with x1.5 ~ x2 driving strength.
	FS0 <sup>&amp;</sup>	IN <sub>td120k</sub>	Latched input for FS0 at initial power up for H/W selecting the output frequency of CPU, 3V66 and PCI clocks. This is internal 120K pull down.
6	PCICLK_F2 <sup>^</sup>	OUT	3.3V free running PCI clock outputs. This pin is with x1.5 ~ x2 driving strength.
	FS1 <sup>&amp;</sup>	IN <sub>td120k</sub>	Latched input for FS1 at initial power up for H/W selecting the output frequency of CPU, 3V66 and PCI clocks. This is internal 120K pull down.
9	PCICLK0 <sup>^</sup>	OUT	3.3V free running PCI clock outputs. This pin is with x1.5 ~ x2 driving strength.
	ENWD*	IN	Latched input for ENWD at initial power up for H/W enable the watch dog timer. This is internal 120K pull up.
10, 11, 12, 15, 16, 17	PCICLK [1:6]	OUT	Low skew (< 250ps) PCI clock outputs.
20, 21, 22	3V66_1, 3V66_2, 3V66_3	OUT	3.3V output clocks for the chipset.

### 5.3 I<sup>2</sup>C Control Interface

PIN	Pin Name	Type	Description
27	SDATA*	I/OD	Serial data of I <sup>2</sup> C 2-wire control interface with internal pull-up resistor.
28	SCLK*	IN	Serial clock of I <sup>2</sup> C 2-wire control interface with internal pull-up resistor.



## STEPLESS CLOCK FOR INTEL BROOKDALE CHIPSET

### 5.4 Fixed Frequency Outputs

PIN	Pin Name	Type	Description
48	REF <sup>^</sup>	OUT	14.318MHz output. This pin is with x1.5 ~ x2 driving strength.
	FS2 <sup>&amp;</sup>	IN <sub>td120k</sub>	Latched input for FS2 at initial power up for H/W selecting the output frequency of CPU, 3V66 and PCI clocks. This is internal 120K pull down.
34	48MHz_DOT	OUT	48MHz clock output for DOT.
35	48MHz_USB	OUT	48MHz clock output for USB.
	FS3 <sup>&amp;</sup>	IN <sub>td120k</sub>	Latched input for FS3 at initial power up for H/W selecting the output frequency. This is internal 120K pull down.

### 5.5 Power Pins

PIN	Pin Name	Description
1,	VDDREF	3.3V power supply for REF.
7, 13	VDDPCI	3.3V power supply for PCI.
18, 30	VDD3V66	3.3V power supply for 3V66.
41, 45	VDDCPU	3.3V power supply for CPU.
24	VDDA	3.3V power supply for analog core.
33	AVDD48	Analog power 3.3V for 48M Hz
4, 8, 14, 19, 25, 29, 32, 36, 42	GND	Ground pin for 3.3 V

## STEPLESS CLOCK FOR INTEL BROOKDALE CHIPSET

### 6. FREQUENCY SELECTION BY HARDWARE OR SOFTWARE

This frequency table is used at power on latched FS [4:0] value or software programming at SSEL [4:0] (Register 1 bit 6 ~ 2).

FS4	FS3	FS2	FS1	FS0	CPU (MHz)	3V66(MHz)	PCI (MHz)	Spread %
0	0	0	0	0	100.90	67.27	33.63	+/-0.25%
0	0	0	0	1	100.30	66.87	33.43	-0.5%
0	0	0	1	0	103.00	68.67	34.33	+/-0.25%
0	0	0	1	1	105.00	70.00	35.00	+/-0.25%
0	0	1	0	0	107.00	71.33	35.67	+/-0.25%
0	0	1	0	1	109.00	72.67	36.33	+/-0.25%
0	0	1	1	0	111.00	74.00	37.00	+/-0.25%
0	0	1	1	1	114.00	76.00	38.00	+/-0.25%
0	1	0	0	0	117.00	78.00	39.00	+/-0.25%
0	1	0	0	1	120.00	80.00	40.00	+/-0.25%
0	1	0	1	0	127.00	84.67	42.33	+/-0.25%
0	1	0	1	1	130.00	86.67	43.33	+/-0.25%
0	1	1	0	0	133.33	88.89	44.44	+/-0.25%
0	1	1	0	1	170.00	56.67	28.33	+/-0.25%
0	1	1	1	0	180.00	60.00	30.00	+/-0.25%
0	1	1	1	1	190.00	63.33	31.67	+/-0.25%
1	0	0	0	0	133.90	66.95	33.48	+/-0.25%
1	0	0	0	1	133.33	66.67	33.33	-0.5%
1	0	0	1	0	120.00	60.00	30.00	+/-0.25%
1	0	0	1	1	125.00	62.50	31.25	+/-0.25%
1	0	1	0	0	134.90	67.45	33.73	+/-0.25%
1	0	1	0	1	137.00	68.50	34.25	+/-0.25%
1	0	1	1	0	139.00	69.50	34.75	+/-0.25%
1	0	1	1	1	141.00	70.50	35.25	+/-0.25%
1	1	0	0	0	143.00	71.50	35.75	+/-0.25%
1	1	0	0	1	145.00	72.50	36.25	+/-0.25%
1	1	0	1	0	150.00	75.00	37.50	+/-0.25%
1	1	0	1	1	155.00	77.50	38.75	+/-0.25%
1	1	1	0	0	160.00	80.00	40.00	+/-0.25%
1	1	1	0	1	170.00	85.00	42.50	+/-0.25%
1	1	1	1	0	66.67	66.67	33.34	+/-0.25%
1	1	1	1	1	200.00	66.67	33.33	+/-0.25%

**STEPLESS CLOCK FOR INTEL BROOKDALE CHIPSET**
**7. I<sup>2</sup>C CONTROL AND STATUS REGISTERS**
**7.1 Register 0: Frequency Select Register (Default = 0)**

Bit	Name	PWD	Description
7	EN_SPSP	0	Enable Spread Spectrum in the frequency table. 0 = Normal 1 = Spread Spectrum enabled
6	SSEL [4]	0	Frequency selection by software via I <sup>2</sup> C.
5	SSEL [3]	0	
4	SSEL [2]	0	
3	SSEL [1]	0	
2	SSEL [0]	0	
1	EN_SSEL	0	Enable software program FS [4:0]. 0 = Select frequency by hardware. 1 = Select frequency by software I <sup>2</sup> C - Bit 6 ~ 2.
0	EN_SAFE_FREQ	0	Enable reload safe frequency when the watchdog is timeout. 0 = reload the FS [4:0] latched pins when watchdog time out. 1 = reload the safe frequency bit defined at Register 6 bit 4~0.

**7.2 Register 1: CPU Clock Register (1 = Enable, 0 = Stopped)**

Bit	Pin NO	PWD	Description
7	47, 46	1	CPUCLKT2 / C2
6	44, 43	1	CPUCLKT1 / C1
5	40, 39	1	CPUCLKT0 / C0
4	-	X	FS [4] Read back.
3	-	X	FS [3] Read back
2	-	X	FS [2] Read back
1	-	X	FS [1] Read back
0	-	X	FS [0] Read back

**7.3 Register 2: PCI Clock Register (1 = Enable, 0 = Stopped)**

Bit	Pin NO	PWD	Description
7	-	X	MULTISEL0 trapping pin data read back
6	17	1	PCICLK 6
5	16	1	PCICLK 5
4	15	1	PCICLK 4
3	12	1	PCICLK 3
2	11	1	PCICLK 2
1	10	1	PCICLK 1
0	9	1	PCICLK 0

## STEPLESS CLOCK FOR INTEL BROOKDALE CHIPSET

### 7.4 Register 3: PCI, 48MHz Clock Register (1 = Enable, 0 = Stopped)

Bit	Pin NO	PWD	Description
7	34	1	48MHZ_DOT
6	35	1	48MHZ_USB
5	48	1	REF
4	-	1	Reserved
3	EN_VCH_CLK	0	1 = VCH_CLK 48MHz clock output. 0 = 3V66_0 66MHz clock output (default).
2	-	1	Reserved
1	6	1	PCICLK_F1
0	5	1	PCICLK_F0

### 7.5 Register 4: 3V66 Control Register (1 = Enable, 0 = Stopped)

Bit	Pin NO	PWD	Description
7	-	1	Reserved
6	-	1	Reserved
5	-	1	Reserved
4	-	1	Reserved
3	22	1	3V66_3
2	21	1	3V66_2
1	20	1	3V66_1
0	31	1	3V66_0/VCH_CLK

### 7.6 Register 5: Watchdog Control Register

Bit	Name	PWD	Description
7	Reserved	0	Reserved
6	EN_WD	X	Enable Watchdog Timer if set to 1. Set to 0, disable watchdog timer. This bit is trapping pin during VTT_PWRGD#. Read this bit will return a counting state. If timer continues down count, this bit will return 1. Otherwise, this bit will return 0.
5	WD_TIMEOUT	0	Watchdog Timeout Status. If the watchdog is started and timer down counts to zero, this bit will be set to 1. Clear this bit to logic 0, If set to 1, when the watchdog is restart in the next time. This bit is Read Only.
4	SAF_FREQ [4]	0	Watchdog safe frequency bits. These bits will be reloaded into FS [4:0], if the watchdog is timeout and enable reload safe frequency bits.
3	SAF_FREQ [3]	0	
2	SAF_FREQ [2]	0	
1	SAF_FREQ [1]	0	
0	SAF_FREQ [0]	0	

**STEPLESS CLOCK FOR INTEL BROOKDALE CHIPSET**
**7.7 Register 6: Watchdog Timer Register**

Bit	Name	PWD	Description
7	WD_TIME [7]	0	Watchdog timeout time. The bit resolution is 250mS. The default time is 8*250mS = 2.0 seconds. If the watchdog timer is start, this register will be down count. Read this register will return a down count value.
6	WD_TIME [6]	0	
5	WD_TIME [5]	0	
4	WD_TIME [4]	0	
3	WD_TIME [3]	1	
2	WD_TIME [2]	0	
1	WD_TIME [1]	0	
0	WD_TIME [0]	0	

**7.8 Register 7: M/N Program Register**

Bit	Name	PWD	Description
7	N_DIV [8]	0	Programmable N divisor value. Bit 7 ~0 are defined in the Register 9.
6	TEST1	1	Test bit 1. Winbond test bit, do not change them.
5	TEST0	0	Test bit 0. Winbond test bit, do not change them.
4	M_DIV [4]	0	Programmable M divisor value.
3	M_DIV [3]	0	
2	M_DIV [2]	0	
1	M_DIV [1]	0	
0	M_DIV [0]	0	

**7.9 Register 8: M/N Program Register**

Bit	Name	PWD	Description
7	N_DIV [7]	0	Programmable N divisor value bit 7 ~0. The bit 8 is defined in Register 8.
6	N_DIV [6]	0	
5	N_DIV [5]	0	
4	N_DIV [4]	0	
3	N_DIV [3]	0	
2	N_DIV [2]	0	
1	N_DIV [1]	0	
0	N_DIV [0]	0	

## STEPLESS CLOCK FOR INTEL BROOKDALE CHIPSET

### 7.10 Register 9: Spread Spectrum Programming Register

Bit	Name	PWD	Description
7	SP_UP [3]	0	Spread Spectrum Up Counter bit 3.
6	SP_UP [2]	0	Spread Spectrum Up Counter bit 2.
5	SP_UP [1]	0	Spread Spectrum Up Counter bit 1.
4	SP_UP [0]	1	Spread Spectrum Up Counter bit 0
3	SP_DOWN [3]	1	Spread Spectrum Down Counter bit 3
2	SP_DOWN [2]	1	Spread Spectrum Down Counter bit 2
1	SP_DOWN [1]	1	Spread Spectrum Down Counter bit 1
0	SP_DOWN [0]	1	Spread Spectrum Down Counter bit 0

### 7.11 Register 10: Divisor and Step-less Enable and Skew Control Register

Bit	Name	PWD	Description
7	EN_MN_PROG	0	0: use frequency table 1: use M/N register to program frequency The equation is <b>VCO freq. = 14.318MHz * (N+4)/ M</b> . When the watchdog timer is timeout, this will be clear. In this time, the frequency is set to hardware default latched or safe frequency set by EN_SFAE_FREQ (Register 1 bit 0).
6	Reserved	0	Reserved
5	RATIO_SEL [2]	0	CPU, 3V66, and PCI ratio selection. The ratio is shown as following table.
4	RATIO_SEL [1]	0	
3	RATIO_SEL [0]	0	
2	CPU_3V66_SKEW [2]	1	CPU to 3V66 skew.
1	CPU_3V66_SKEW [1]	0	
0	CPU_3V66_SKEW [0]	0	

### Table of CPU, 3V66, and PCI clock selection.

Reg10 Bit5	Reg10 Bit4	Reg10 Bit3	VCO / CPU	VCO / 3V66	VCO / PCI
SEL2	SEL1	SEL0	Ratio	Ratio	Ratio
0	0	0	2	4	8
0	0	1	2	5	10
0	1	0	2	6	12
0	1	1	3	6	12
1	0	0	4	4	8
1	0	1	4	6	12
1	1	0	6	6	12
1	1	1	X	X	X

## STEPLESS CLOCK FOR INTEL BROOKDALE CHIPSET

### 7.12 Register 11: Winbond Chip ID Register (Read Only)

Bit	Name	PWD	Description
7	CHPI_ID [7]	0	Winbond Chip ID. W83194BR-B is 0x32.
6	CHPI_ID [6]	0	Winbond Chip ID.
5	CHPI_ID [5]	1	Winbond Chip ID.
4	CHPI_ID [4]	1	Winbond Chip ID.
3	CHPI_ID [3]	0	Winbond Chip ID.
2	CHPI_ID [2]	0	Winbond Chip ID.
1	CHPI_ID [1]	1	Winbond Chip ID.
0	CHPI_ID [0]	0	Winbond Chip ID.

### 7.13 Register 12: Winbond Chip ID Register (Read Only)

Bit	Name	PWD	Description
7	SUB_ID [3]	0	Winbond Sub-Chip ID. The sub-chip ID of W83194BR-B is defined as 0001b.
6	SUB_ID [2]	0	Winbond Sub-Chip ID.
5	SUB_ID [1]	0	Winbond Sub-Chip ID.
4	SUB_ID [0]	1	Winbond Sub-Chip ID.
3	VER_ID [3]	0	Winbond Version ID. The Version ID of W83194BR-B is 0001b.
2	VER_ID [2]	0	Winbond Version ID.
1	VER_ID [1]	0	Winbond Version ID.
0	VER_ID [0]	1	Winbond Version ID.

### 7.14 Register 81: Winbond Test Register I

Bit	Name	PWD	Description
7:0	TEST_REG1	00h	Winbond Test Register. User don't write it, otherwise this chip will get an unexpected result.

### 7.15 Register 82: Winbond Test Register II

Bit	Name	PWD	Description
7:0	TEST_REG2	04h	Winbond Test Register. User don't write it, otherwise this chip will get an unexpected result.

## STEPLESS CLOCK FOR INTEL BROOKDALE CHIPSET

### 8. ACCESS INTERFACE

The W83194BR-B provides I<sup>2</sup>C Serial Bus for microprocessor to read/write internal registers. In the W83194BR-B is provided Block Read/Block Write and Byte-Data Read/Write protocol. The I<sup>2</sup>C address is defined at 0xD2.

#### 8.1 Block Write protocol

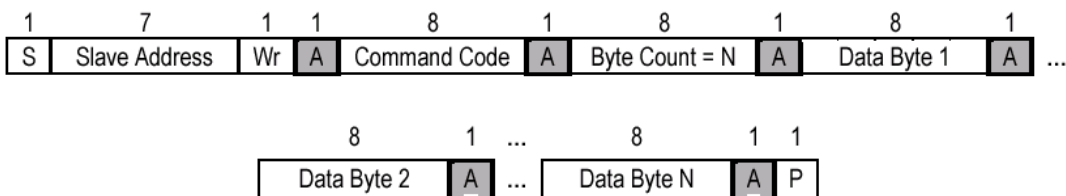

#### 8.2 Block Read protocol

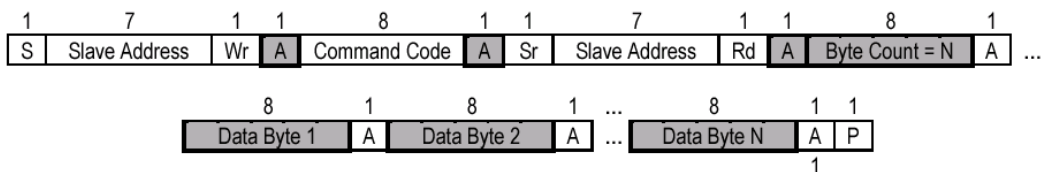

## In block mode, the command code must filled 8'h00

#### 8.3 Byte Write protocol

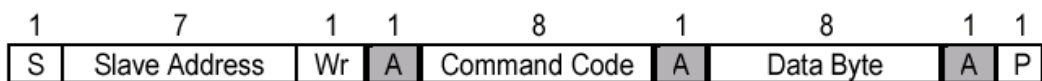

#### 8.4 Byte Read protocol

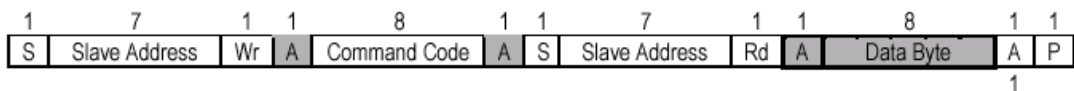



**STEPLESS CLOCK FOR INTEL BROOKDALE CHIPSET****9. SPECIFICATIONS****9.1 ABSOLUTE MAXIMUM RATINGS**

Stresses greater than those listed in this table may cause permanent damage to the device. Precautions should be taken to avoid application of any voltage higher than the maximum rated voltages to this circuit. Subjection to maximum conditions for extended periods may affect reliability. Unused inputs must always be tied to an appropriate logic voltage level (Ground or Vdd).

<b>Parameter</b>	<b>Rating</b>
Absolute 3.3V Core Supply Voltage	- 0.5 V to + 4.6 V
Absolute 3.3V I/O Supply Voltage	- 0.5 V to + 4.6 V
Operating 3.3V Core Supply Voltage	3.135V to 3.465 V
Operating 3.3V I/O Supply Voltage	3.135V to 3.465 V
Storage Temperature	- 65°C to + 150°C
Ambient Temperature	- 55°C to + 125°C
Operating Temperature	0°C to + 70°C
Input ESD protection (Human body model)	2000V

**10. ORDERING INFORMATION**

<b>Part Number</b>	<b>Package Type</b>	<b>Production Flow</b>
W83194BR-B	48 PIN SSOP	Commercial, 0°C to +70°C

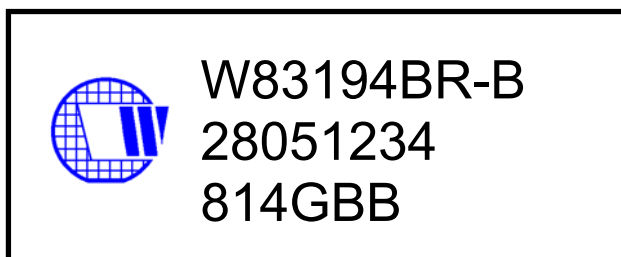
**STEPLESS CLOCK FOR INTEL BROOKDALE CHIPSET****11. HOW TO READ THE TOP MARKING**

1st line: Winbond logo and the type number: W83194BR-B

2nd line: Tracking code 2 8051234

2: wafers manufactured in Winbond FAB 2

**8051234**: wafer production series lot number

3rd line: Tracking code 814 G BB

**814**: packages made in '98, week 14

**G**: assembly house ID; O means OSE, G means GR

**A**: Internal use code

**B**: IC revision

All the trademarks of products and companies mentioned in this data sheet belong to their respective owners.

## STEPLESS CLOCK FOR INTEL BROOKDALE CHIPSET

### 12. PACKAGE DRAWING AND DIMENSIONS

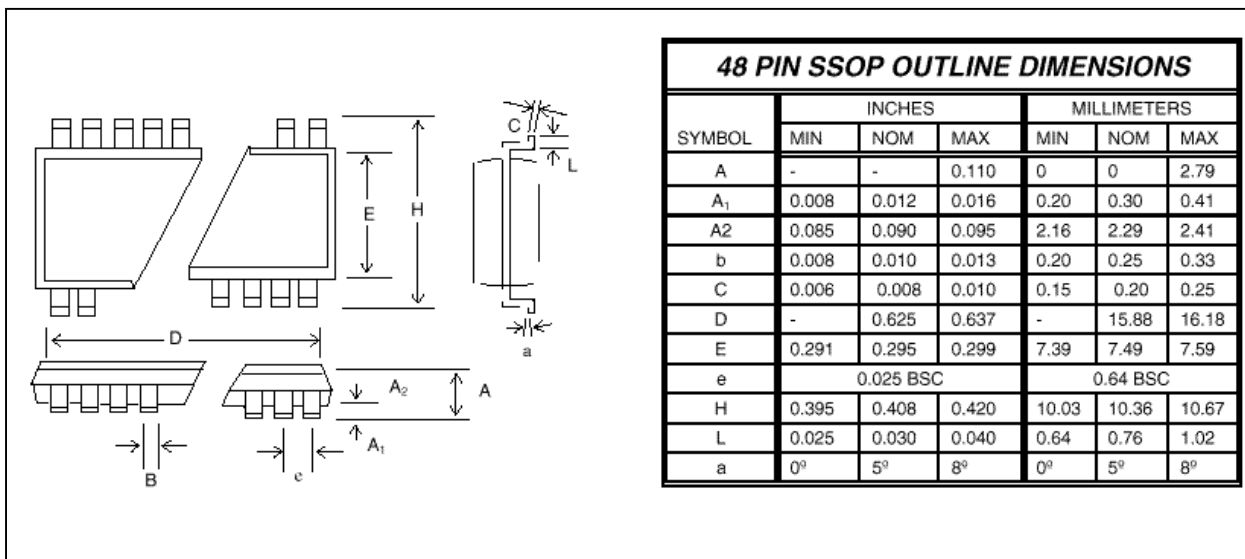

#### Headquarters

No. 4, Creation Rd. III  
 Science-Based Industrial Park  
 Hsinchu, Taiwan  
 TEL: 886-35-770066  
 FAX: 886-35-789467  
 www: <http://www.winbond.com.tw/>

#### Taipei Office

9F, No. 480, Rueiguang Road, Neihu District,  
 Taipei, 114, Taiwan  
 TEL: 886-2-81777168  
 FAX: 886-2-87153579

#### Winbond Electronics (H.K.) Ltd.

Rm. 803, World Trade Square, Tower II  
 123 Hoi Bun Rd., Kwun Tong  
 Kowloon, Hong Kong  
 TEL: 852-27516023-7  
 FAX: 852-27552064

#### Winbond Electronics

#### (North America) Corp.

2727 North First Street  
 San Jose, California 95134  
 TEL: 1-408-9436666  
 FAX: 1-408-9436668

Please note that all data and specifications are subject to change without notice. All the trade marks of products and companies mentioned in this data sheet belong to their respective owners.

These products are not designed for use in life support appliances, devices, or systems where malfunction of these products can reasonably be expected to result in personal injury.

Winbond customers using or selling these products for use in such applications do so at their own risk and agree to fully indemnify Winbond for any damages resulting from such improper use or sale.