

10A SCHOTTKY BARRIER DIODE

Full Pack High Voltage Schottky Rectifier

Specification Features:

- High Voltage Wide Range Selection, 100V, 150V & 200V
- High Switching Speed Device
- Low Forward Voltage Drop
- Low Power Loss and High Efficiency
- Guard Ring for Over-voltage Protection
- High Surge Capability
- RoHS Compliant
- Matte Tin(Sn) Lead Finish
- Terminal Leads Surface is Corrosion Resistant and can withstand to 260°C Wave Soldering or per MIL-STD-750, Method 2026.

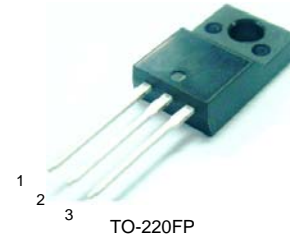

TO-220FP

DEVICE MARKING DIAGRAM

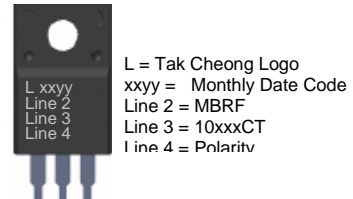

POLARITY CONFIGURATION

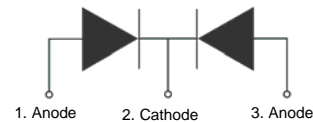

MAXIMUM RATINGS (Per Leg, unless otherwise specified)

Symbol	Parameter	MBRF10100CT	MBRF10150CT	MBRF10200CT	Units
V_{RRM} V_{RWM} V_R	Maximum Repetitive Reverse Voltage Working Peak Reverse Voltage Maximum DC Reverse Voltage	100	150	200	V
$I_{F(AV)}$	Average Rectified Forward Current Per Leg Per Package		5 10		A
I_{FSM}	Non-repetitive Peak Forward Surge Current 8.3mS Single Phase @ Rated Load		80		A
T_{STG}	Storage Temperature Range		-65 to +150		°C
T_J	Operating Junction Temperature		+150		°C

These ratings are limiting values above which the serviceability of the diode may be impaired.

THERMAL CHARACTERISTIC

Symbol	Parameter	Value	Units
$R_{\theta JC}$	Maximum Thermal Resistance, Junction-to-Case	1.5	°C/W
$R_{\theta JA}$	Maximum Thermal Resistance, Junction-to-Ambient (per leg)	62.5	°C/W

ELECTRICAL CHARACTERISTICS (Per Leg) $T_A = 25^\circ\text{C}$ unless otherwise noted

Symbol	Parameter	Test Condition (Note 1)	MBRF10100CT		MBRF10150CT		MBRF10200CT		Units
			Min	Max	Min	Max	Min	Max	
I_R	Reverse Current	@ rated V_R	---	100	---	100	---	100	μA
V_F	Forward Voltage	$I_F = 5\text{A}$	---	0.85	---	0.92	---	1.00	V
		$I_F = 10\text{A}$	---	0.95	---	1.00	---	1.25	

Note/s:

1. Tested under pulse condition of 300 μs .

TYPICAL CHARACTERISTICS
Figure 1. Forward Current Derating Curve (Per Diode)

Figure 2. Junction Capacitance (Per Diode)

Figure 3. MBRF10100CT Typical Reverse Current (Per Diode)

Figure 4. MBRF10150CT Typical Reverse Current (Per Diode)

Figure 5. MBRF10200CT Typical Reverse Current (Per Diode)

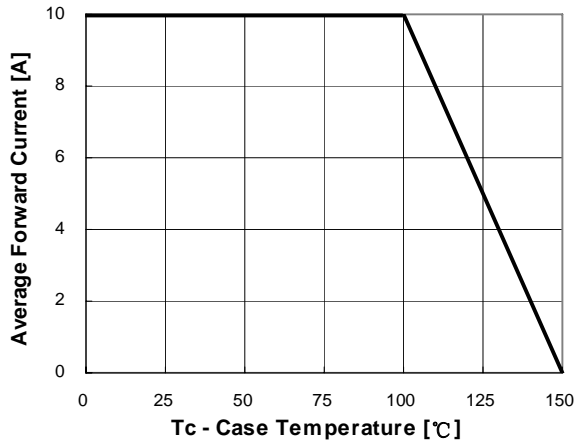
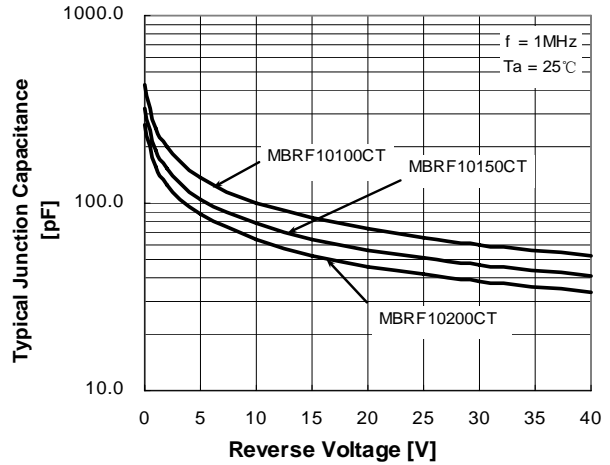
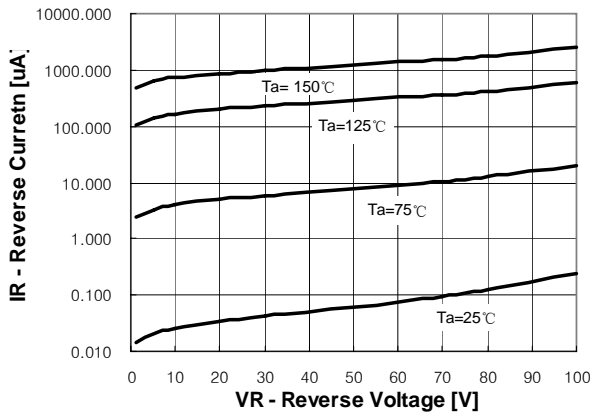
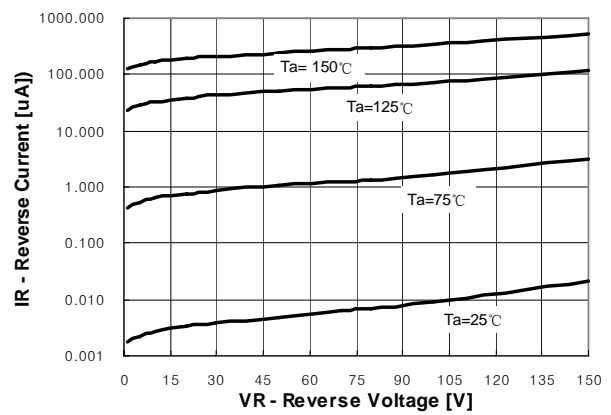
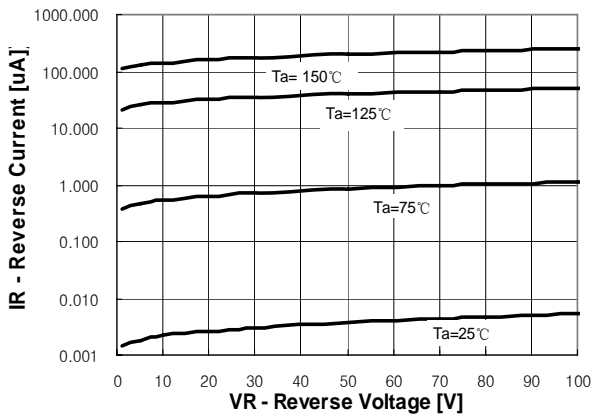
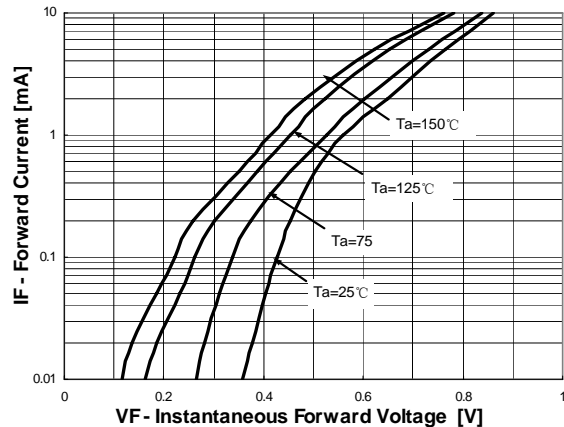
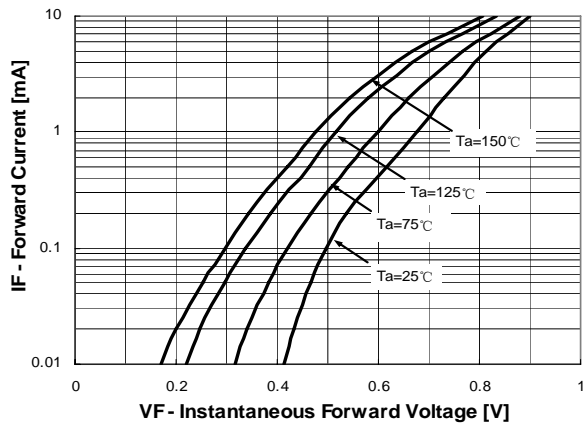
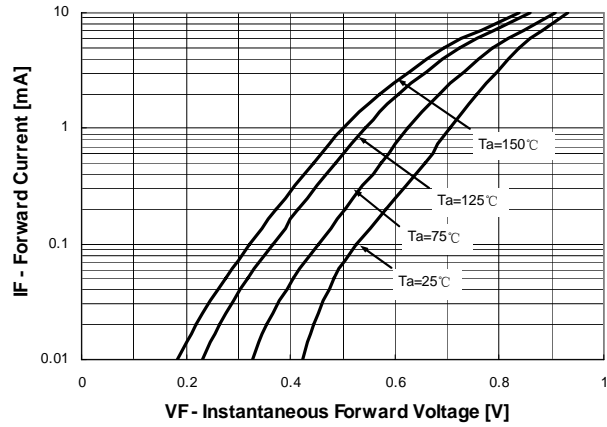
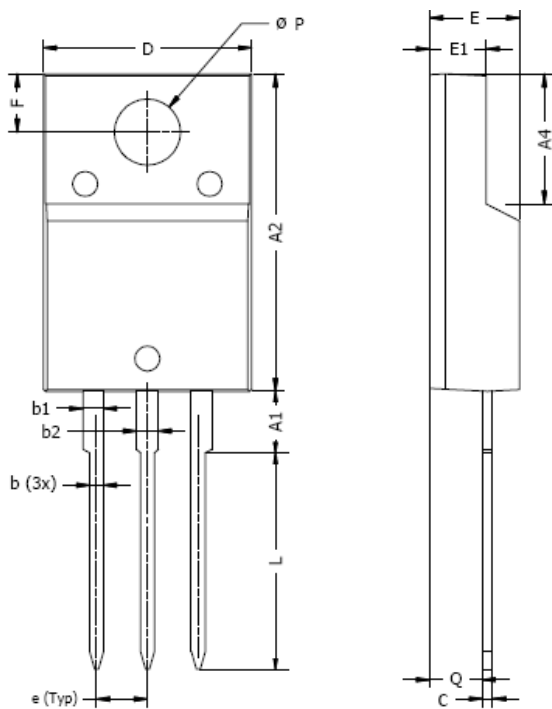
Figure 6. MBRF10100CT Typical Forward Voltage (Per Diode)

Figure 7. MBRF10150CT Typical Forward Voltage (Per Diode)

Figure 8. MBRF10200CT Typical Forward Voltage (Per Diode)

TO220FP SINGLE GAUGE PACKAGE OUTLINE

DIM	MILLIMETERS		INCHES	
	MIN	MAX	MIN	MAX
A1	2.7	3.3	0.106	0.130
A2	15.0	15.7	0.591	0.618
A4	6.2	6.6	0.244	0.260
b	0.5	0.9	0.020	0.035
b1	0.9	1.2	0.035	0.047
b2	1.0	1.2	0.039	0.047
c	0.4	0.6	0.016	0.024
D	9.8	10.3	0.386	0.406
e	2.34	2.74	0.092	0.108
E	4.3	4.6	0.169	0.181
E1	2.5	2.9	0.098	0.114
F	2.6	3.0	0.102	0.118
L	10.3	10.7	0.406	0.421
ØP	3.0	3.4	0.118	0.134
Q	2.3	2.7	0.091	0.106

NOTICE

The information presented in this document is for reference only. Tak Cheong reserves the right to make changes without notice for the specification of the products displayed herein.

The product listed herein is designed to be used with ordinary electronic equipment or devices, and not designed to be used with equipment or devices which require high level of reliability and the malfunction of which would directly endanger human life (such as medical instruments, transportation equipment, aerospace machinery, nuclear-reactor controllers, fuel controllers and other safety devices), Tak Cheong Semiconductor Co., Ltd., or anyone on its behalf, assumes no responsibility or liability for any damages resulting from such improper use of sale.

This publication supersedes & replaces all information previously supplied. For additional information, please visit our website <http://www.takcheong.com>, or consult your nearest Tak Cheong's sales office for further assistance.