

**RoHS  215 Series, 5 x 20 mm, Time-Lag (Slo-Blo®) Fuse**

**Description**

5x20mm Time-Lag surge withstand ceramic body cartridge fuse designed to IEC specification











**Features**

- Designed to International (IEC) Standards for use globally
- High breaking capacity
- Meet the IEC 60127-2, Sheet 5 specification for Time-Lag fuses
- RoHS compliant and lead-free

**Applications**

Used as supplementary protection in appliance or utilization equipment to provide individual protection for components or internal circuits.

**Agency Approvals**

Agency	Agency File Number	Ampere Range
	Cartridge Certificates: NBK080205-E10480A NBK250702-E10480E NBK100408-JP1021A Leaded Certificates: NBK080205-E10480B NBK250702-E10480F NBK100408-JP1021B	1A – 5A 6.3A – 15A 16A – 20A  1A – 5A 6.3A – 15A 16A – 20A
	Certificates: 2005010207145714	1A – 6.3A
	Certificates: SU05001– 2011 SU05001– 2012	1A – 3.15A 4A – 10A
	Recognised File: E10480	125mA – 20A
	File: 029862 Acc. Class: LR1422 – 30	500mA – 12A
	License: 606726 902193 1117976 709071 709302	125mA, 160mA 200mA – 800mA, 8A, 10A 1A - 6.3A 12A *15A – *20A
	License: 40013521	200mA – 8A *10A
	License: 40016610	*12A
	License: KM41462	200mA – 10A
		125mA – 20A

\* Approved for cartridge versions only

**Electrical Characteristics for Series**

% of Ampere Rating	Ampere Rating	Opening Time
150%	125mA – 800mA	60 minutes, Minimum
	1A – 3.15A	60 minutes, Minimum
	4A – 6.3A	60 minutes, Minimum
	8A – 20A	30 minutes, Minimum
210%	125mA – 800mA	30 minutes, Maximum
	1A – 3.15A	30 minutes, Maximum
	4A – 6.3A	30 minutes, Maximum
	8A – 12A	30 minutes, Maximum
275%	125mA – 800mA	.25 sec. Min.; 80 secs. Max.
	1A – 3.15A	.75 sec. Min.; 80 secs. Max.
	4A – 6.3A	.75 sec. Min.; 80 secs. Max.
	8A – 20A	.75 sec. Min.; 80 secs. Max.
400%	125mA – 800mA	.05 sec., Min.; 5 secs. Max.
	1A – 3.15A	.095 sec., Min.; 5 secs. Max.
	4A – 6.3A	.150 sec., Min.; 5 secs. Max.
	8A – 20A	.150 sec., Min.; 5 secs. Max.
1000%	125mA – 800mA	.005 sec., Min.; .150 sec. Max.
	1A – 3.15A	.010 sec., Min.; .150 sec. Max.
	4A – 6.3A	.010 sec., Min.; .150 sec. Max.
	8A – 20A	.010 sec., Min.; .150 sec. Max.

### Electrical Characteristic Specifications by Item

Amp Code	Amp Rating	Voltage Rating (V)	Interrupting Rating	Nominal Cold Resistance (Ohms)	Nominal Melting I <sup>2</sup> t (A <sup>2</sup> sec)	Maximum Voltage Drop at Rated Current (mV)	Maximum Power Dissipation at Rated Current (W)	Agency Approvals													
								UL	PSF	CCC	CEC	RU	SP	S	D'E	VDE	CE				
.125	0.125	250	1500 A @ 250 VAC	11.4455	0.0330	2600	1.6							x		x				x	
.160	0.16	250		7.1000	0.0465	2400	1.6								x		x				x
.200	0.2	250		1.8400	0.340	2100	1.6	x							x		x	x			x
.250	0.25	250		1.2400	0.545	1500	1.6	x							x		x	x			x
.315	0.315	250		0.8800	0.975	1100	1.6	x							x		x	x			x
.400	0.4	250		0.5825	1.325	1000	1.6	x							x		x	x			x
.500	0.5	250		1.1675	0.420	850	1.6	x							x	x	x	x			x
.630	0.63	250		0.7200	0.635	650	1.6	x							x	x	x	x			x
.800	0.8	250		0.4675	0.975	500	1.6	x							x	x	x	x			x
001.	1	250		0.1515	1.520	350	2.5	x	x	x	x	x	x	x	x	x	x	x			x
1.25	1.25	250		0.1074	3.200	300	2.5	x	x	x	x	x	x	x	x	x	x	x			x
01.6	1.6	250		0.0707	6.830	200	2.5	x	x	x	x	x	x	x	x	x	x	x			x
002.	2	250		0.0566	11.680	190	2.5	x	x	x	x	x	x	x	x	x	x	x			x
02.5	2.5	250		0.0386	22.290	180	2.5	x	x	x	x	x	x	x	x	x	x	x			x
3.15	3.15	250		0.0283	43.255	140	4	x	x	x	x	x	x	x	x	x	x	x			x
004.	4	250		0.0185	46.960	100	4	x	x	x	x	x	x	x	x	x	x	x			x
005.	5	250		0.0153	66.095	100	4	x	x	x	x	x	x	x	x	x	x	x			x
06.3	6.3	250		0.0108	128.750	100	4	x	x	x	x	x	x	x	x	x	x	x			x
008.	8	250		0.0092	209.880	100	4	x	x		x	x	x	x	x	x	x	x			x
010.	10	250		0.0066	333.565	100	4	x	x		x	x	x	x	x	x	x	x*			x
012.	12	250	0.0061	515.500	100	4		x			x	x	x					x*		x	
015.	15	250	500 A	0.0033	1237.0	TBA**	TBA**		x					x		x*					
016.	16	250		0.0031	1408.0	TBA**	TBA**		x						x		x*				
020.	20	250	400 A	0.0023	2600.0	TBA**	TBA**		x					x		x*					

X\* Approval for cartridge versions only

TBA\*\* - Please contact Littelfuse for details on these parameters

1A to 2A have an IR : 100A@500VAC, 4A to 6-3A have the IR : 100A@305 VAC and 1000A@72VDC

I<sup>2</sup>t test at 10x rated current.

### Temperature Derating Curve

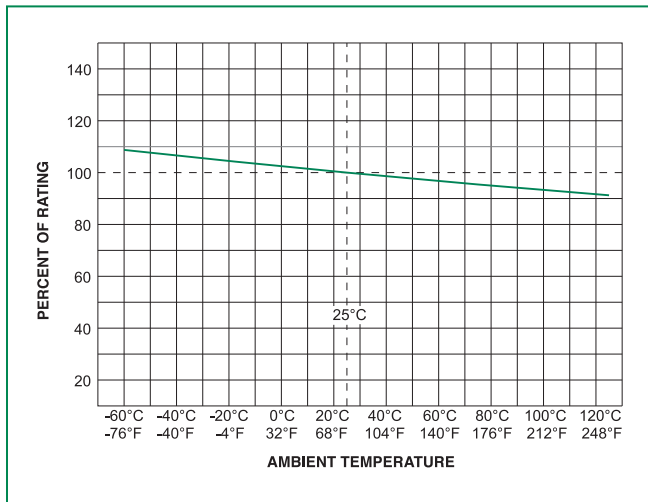

### Average Time Current Curves

T-C Curves for 125mA to 800mA only

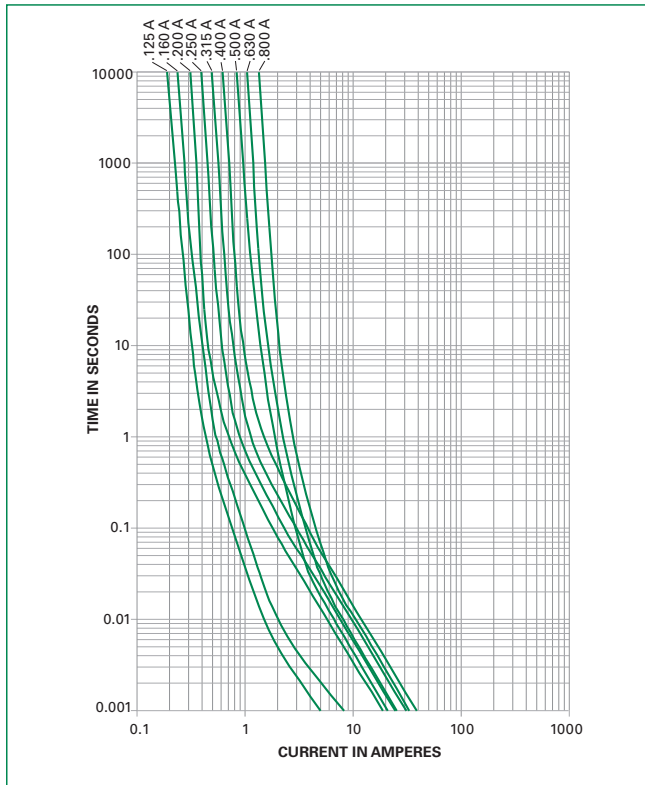

T-C Curves for 1A to 20A only

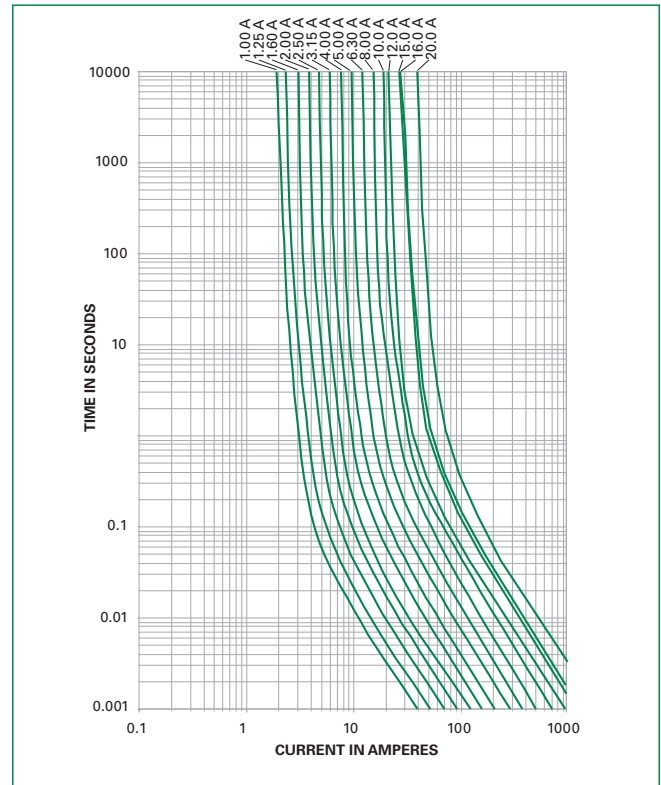

### Product Characteristics

<b>Materials</b>	<b>Body:</b> Ceramic <b>Cap:</b> Nickel-plated Brass <b>Leads:</b> Tin-plated Copper
<b>Terminal Strength</b>	MIL-STD-202G, Method 211A, Test Condition A
<b>Solderability</b>	Reference IEC 60127 Second Edition 2003-01 Annex A
<b>Product Marking</b>	<b>Cap 1:</b> Brand logo, current and voltage ratings <b>Cap 2:</b> Agency approval markings

<b>Operating Temperature</b>	-55°C to +125°C
<b>Thermal Shock</b>	MIL-STD-202G, Method 107G, Test Condition B (5 cycles, -65°C to +125°C)
<b>Vibration</b>	MIL-STD-202G, Method 201A
<b>Humidity</b>	MIL-STD-202G, Method 103B, Test Condition A (High RH (95%) and elevated temp (40°C) for 240 hours)
<b>Salt Spray</b>	MIL-STD-202G, Method 101D, Test Condition B

### Soldering Parameters - Wave Soldering

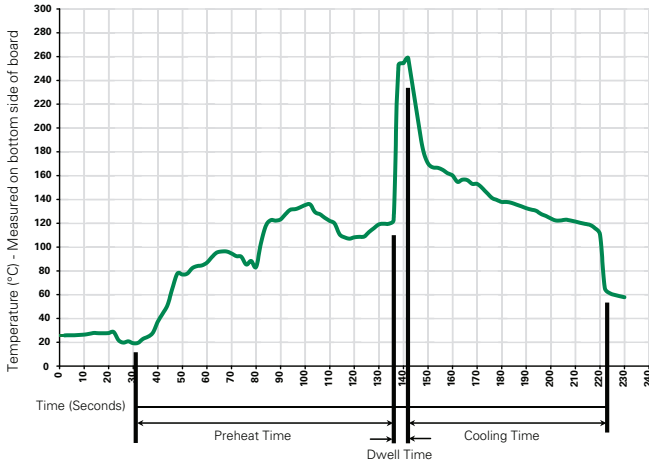

### Recommended Process Parameters:

Wave Parameter	Lead-Free Recommendation
<b>Preheat:</b> (Depends on Flux Activation Temperature)	(Typical Industry Recommendation)
Temperature Minimum:	100° C
Temperature Maximum:	150° C
Preheat Time:	60-180 seconds
<b>Solder Pot Temperature:</b>	260° C Maximum
<b>Solder Dwell Time:</b>	2-5 seconds

### Recommended Hand-Solder Parameters:

Solder Iron Temperature: 350° C +/- 5° C  
 Heating Time: 5 seconds max.

**Note: These devices are not recommended for IR or Convection Reflow process.**

Different values of A and B available, please contact the Littelfuse sales representative in your region:

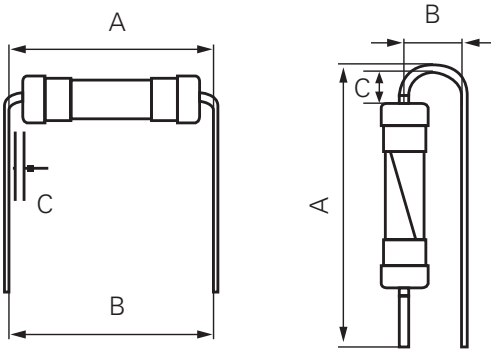

For the pigtailed fuse, please follow the recommendations below for axial lead forming and mounting into PCB:

#### Lead forming:

The distance C between cap flat surface and axial lead shall be greater than 1.0 mm.

#### PCB mounting:

The distance between PCB and fuse cap is recommended to be a minimum of 1.5 mm.

### Dimensions

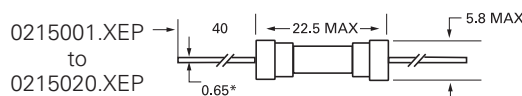
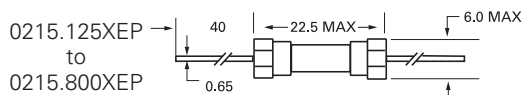
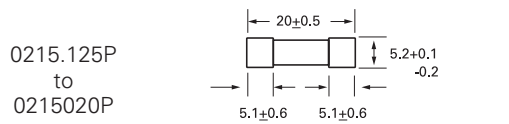

All dimensions in mm

\* Ratings above 6.3 A have 0.8 mm diameter lead;  
 ratings above 12 A have 1.2 mm diameter lead

### Part Numbering System

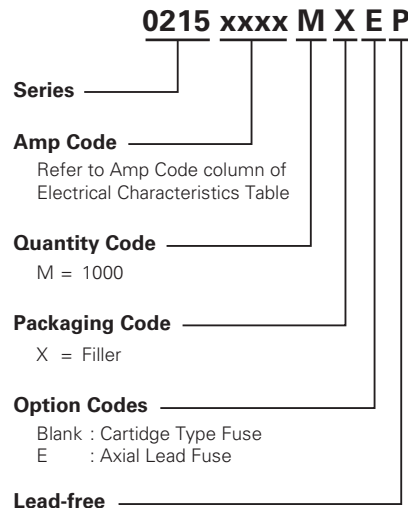

### Packaging

Packaging Option	Packaging Specification	Quantity	Quantity & Packaging Code	Taping Width
<b>215 Series</b>				
Bulk	N/A	1000	MX	N/A
Bulk	N/A	1000	MXE	N/A
Reel and Tape	N/A	1000	MRET1	T1=52mm (2.062")
Bulk	N/A	1000	MXG	N/A
Bulk	N/A	1000	MXB	N/A
Bulk	N/A	100	HX	N/A