

AMPOWER DISCONNECT TERMINAL CRIMPING DIES	
USED IN CRIMPING HEAD 69082 or 1752786-1	USED IN CRIMPING HEAD 69099 or 1752868-1
46753-3	
46758-2	
46758-3	68200-1
68204-1	68201-1
68206-1	68203-1
68332-1	

Figure 1

1. INTRODUCTION

This instruction sheet provides information on product application and a maintenance and inspection procedure for AMPOWER Disconnect Terminal Crimping Dies listed in the table in Figure 1.

These crimping dies are used to crimp AMPOWER Quick Disconnect Terminals on wire sizes No. 1/0 through 777 MCM.

Basic instructions on the use of the dies, wire preparation, etc., are provided in Section 2, INSTRUCTIONS. Section 3 features a terminal "Crimp Inspection" procedure, and Section 4 contains "Maintenance and Inspection Procedures" which will enable you to maintain a die certification program.

The dies are coated with preservative to prevent rust and corrosion. Wipe this preservative from the dies, particularly from the crimping areas.

For further instructions relative to the hydraulic power unit and hydraulic crimping heads, refer to the instructions packaged with these tools.



NOTE

All dimensions on this document are in metric units [with U.S. customary units in brackets]. Figures and illustrations are for identification only and are not drawn to scale.

Reason for revision is provided in Section 5, REVISION SUMMARY.

2. CRIMPING PROCEDURES



NOTE

Crimping Head No. 69082 is illustrated throughout this document, however, crimping instructions are the same for 69082, 69099, 1752786-1, or 1752868-1 crimping heads.

2.1. Die Insertion



DANGER

Avoid personal injury, when using power unit, exercise caution to avoid accidentally depressing the foot pedals or trigger control when changing dies.

1. Select the correct dies for wire size being used. See Figure 2.
2. Loosen the lock screw in the top section of the crimping head. See Figure 1.
3. Insert the shank of the stationary die into the top section of the crimping head and tighten the lock screw. See Figure 1.



NOTE

Ensure the dies are inserted "fully" and "flats" on the shanks are facing the lock screws.

4. Activate the power unit, advance the ram until the lock screw is visible
5. Loosen the lock screw and insert the shank of the moving die into the ram. Tighten the lock screw. See Figure 1.
6. Active the power unit to complete the cycle and allow the ram to return to the "Down" position.



NOTE

Observe that the shanks are offset on the 500, 600, and 777 MCM moving and stationary dies. Ensure that the shank of each die is offset to the same side in order to maintain the proper mating of dies.

2.2. Die Removal

1. Loosen the lock screw in the top section of the crimping head and remove the stationary die.
2. Advance the ram until the lock screw is visible. Loosen the lock screw and remove the dies.

WIRE SIZE	DIE SET NUMBER	CRIMPING HEAD NUMBER	WIRE STRIP LENGTH	
			MINIMUM	MAXIMUM
1/0	68200-1	69099	23.82 [.938]	25.4 [1.000]
2/0	68201-1	69099	23.82 [.938]	25.4 [1.000]
250 MCM	68203-1	69099	39.67 [1.562]	41.28 [1.625]
350 MCM	68204-1	68082	39.67 [1.562]	41.28 [1.625]
400 MCM (2 Crimps)	68332-1	68082	44.45 [1.750]	46.02 [1.812]
500 MCM (2 Crimps)	68206-1	68082	44.45 [1.750]	46.02 [1.812]
600 MCM (2 Crimps)	46757-3	68082	50.8 [2.000]	52.37 [2.062]
777 MCM (2 Crimps)	46758-2, 46758-3	68082	50.8 [2.000]	52.37 [2.062]

Figure 2

2.3. Wire Stripping and Crimping Procedures



DANGER

Avoid personal injury. When operating power unit, exercise caution while holding terminals or wire near crimping area.

A. Wire Stripping Procedure

1. Select the proper size terminals and die set for the wire size being used. See Figure 2.
2. Strip the wire to the dimensions indicated in Figure 2.



CAUTION

Do NOT nick or cut conductor strands.

B. Crimping Procedures (Single Crimp) 1/0 Through 350 MCM Terminals (Figure 3)

1. Ensure the wire size stamped on the terminal corresponds with the wire size stamped on the dies.
2. Orient the 1/0 terminal with the dies so the large slot in the terminal is rotated 30° to 60° from the vertical as shown in Figure 3A. Orient the 250 MCM and 350 MCM terminals with the dies so that the large slot in the terminals is rotated 45° from the vertical as shown in Figure 3A.
3. Position the terminals so the dies are centered on the wire barrels of the terminals as shown in Figure 3A.
4. Activate the power unit so the moving die advances and holds the terminal in place. Do NOT deform the terminal.
5. Insert a stripped wire all the way into the terminal wire barrel. Activate the power unit to complete the crimp.
6. Refer to Section 3 and Figure 5 for crimp inspection.

C. Crimping Procedures (Dual Crimp) 400 MCM Terminals (Figure 3)

1. Ensure the wire size stamped on the terminal corresponds with the wire size stamped on the dies.

A
1/0

Large Slot in Terminal Must be Rotated 45° from Vertical

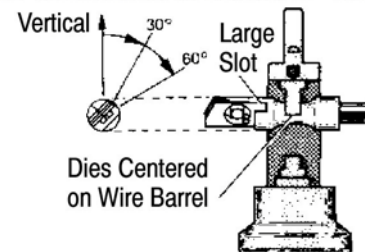

Large Slot in Terminal Must be Rotated 45° from Vertical

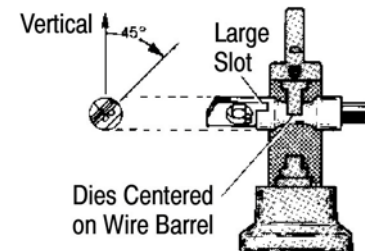

B
400 MCM

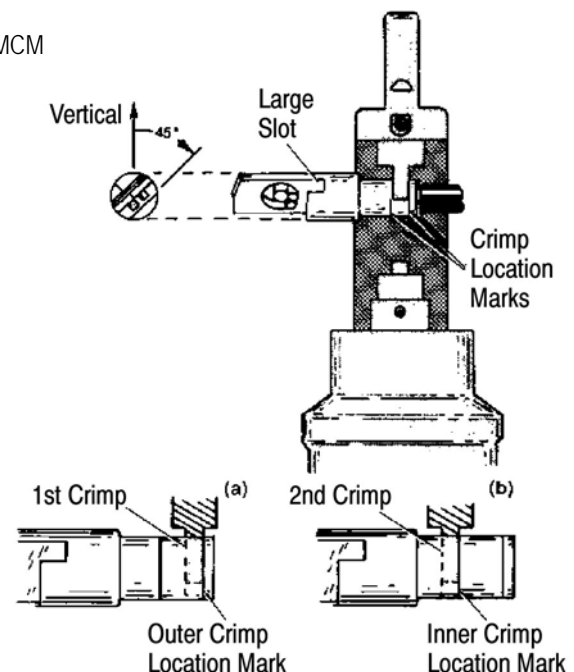

Figure 3

2. Orient all terminals with the dies so the large slot in the terminal is rotated 45° from the vertical as shown in Figure 3B.

3. **First Crimp** - Position the terminal so the edge of the stationary die is aligned with the outer crimp location mark as shown in Figure 3B(a).

4. Activate the power unit so the moving die advances and holds the terminal in place. Do NOT deform the terminals.

5. Insert a stripped wire all the way into the terminal wire barrel.



CAUTION

Do NOT allow the wire insulation to enter the barrel of the terminal.

6. Activate the power unit to complete the first crimp.

7. **Second Crimp** - Position the terminal so the edge of the stationary die is aligned with the inner crimp location mark as shown in Figure 3B(b).

8. Activate the power unit to complete the second crimp.

9. Refer to Section 3 and Figure 5 for crimp inspection.

D. Crimping Procedures (Dual Crimp) 500, 600, and 777 MCM Terminals (Figure 4)

1. Ensure the wire size stamped on the terminal corresponds with the wire size stamped on the dies.

2. Orient the terminal with the dies so the large slot in the terminal is rotated 45° from the vertical as shown in Figure 4A.

3. **First Crimp** - Position the terminal so the dies are centered between the crimp marks on the wire barrel of the terminal as shown in Figure 4B(a).

4. Activate the power unit so the moving die advances and holds the terminal in place. Do NOT deform the terminal barrel.

5. Insert a stripped wire all the way into the terminal barrel.



NOTE

For larger sizes:

- (a) Recommend use of PTFE spray on both crimping dies and the terminal before crimping for easier removal after crimping. When using the PTFE spray on the terminal, cover the hole of the terminal by masking tape to prevent lubricant oil to be soaked inside the terminal.
- (b) Recommend the use of a rubber mallet to detach the terminal from the die after crimping if the terminal is difficult to detach by hand.



CAUTION

Do NOT allow the wire insulation to enter the barrel of the terminal.

A
500, 600, 777 MCM

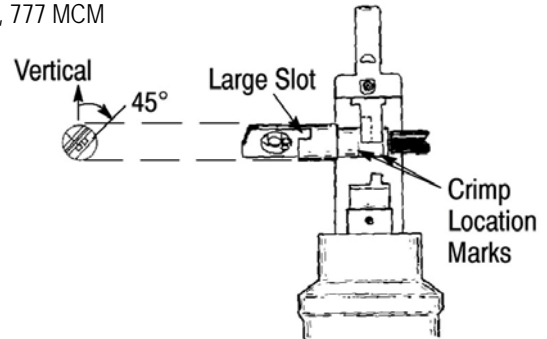

B

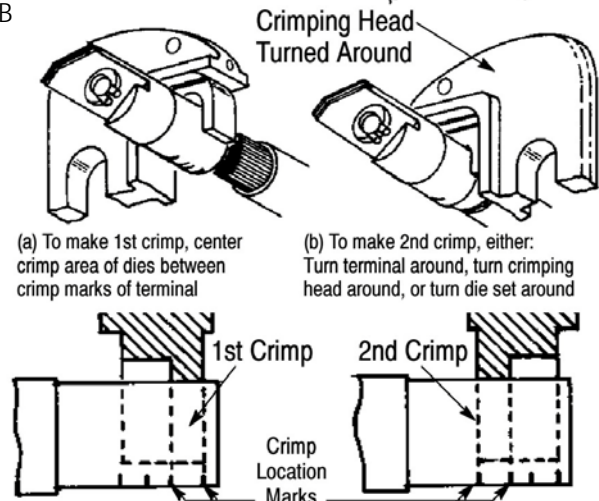

Figure 4

6. Activate the power unit to complete the first crimp.

7. Remove the terminal from the die.

8. Before making the second crimp on the terminal, it will be necessary to either:

- Turn the terminal around
- Turn the crimping head around
- Turn the die set around

9. **Second Crimp** - Position the terminal in the die as shown in Figure 4B.

10. Activate the power unit to complete the second crimp.

11. Refer to Section 3 and Figure 5 for crimp inspection.

3. CRIMP INSPECTION

Inspect crimped terminals by checking the features described in Figure 5. Use only terminals meeting the conditions shown in the "ACCEPT" column. "REJECT" terminals can be avoided through careful use of instructions in Section 2, and by performing regular die maintenance as instructed in Section 4.

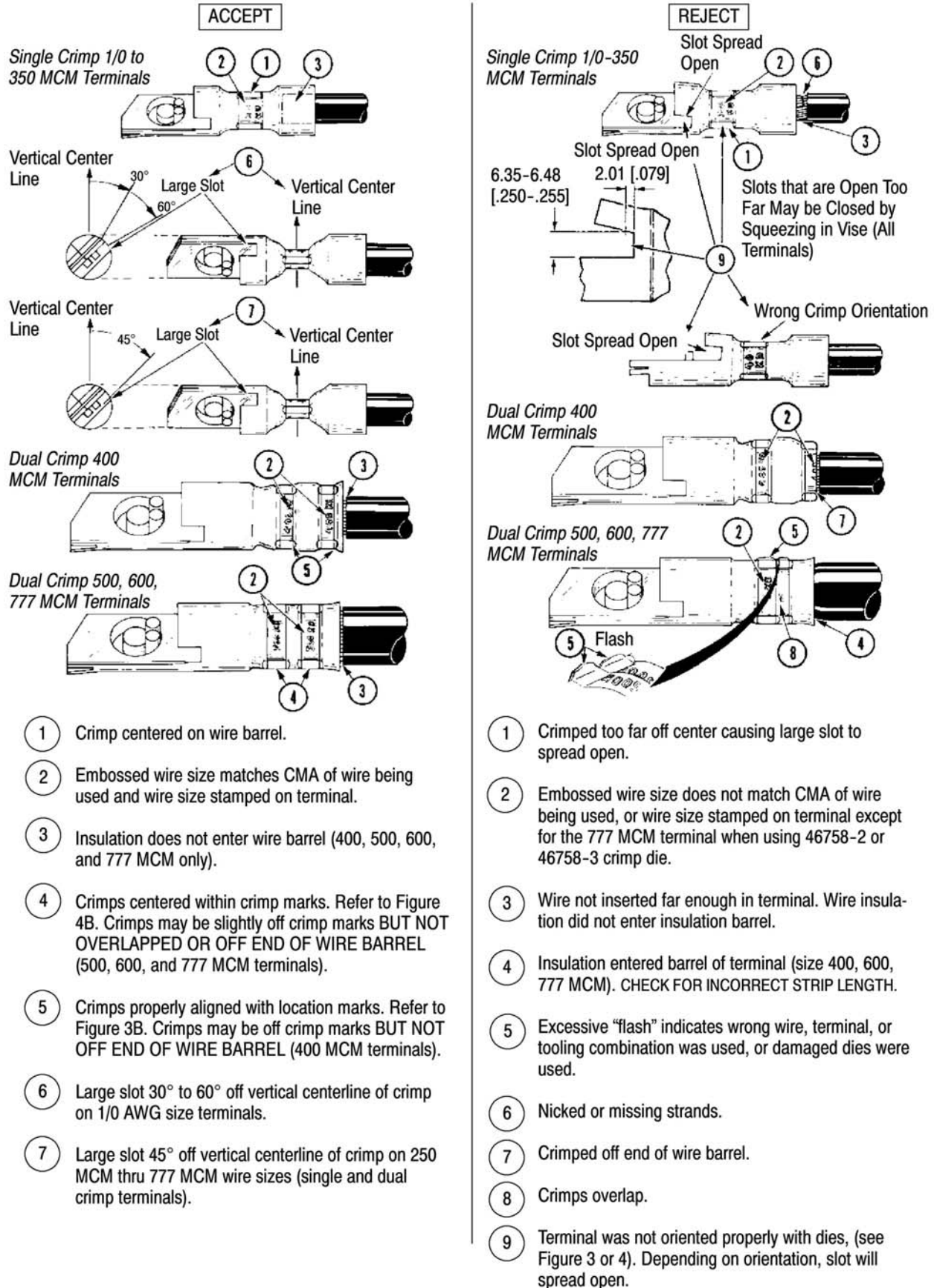

Figure 5

4. MAINTENANCE AND INSPECTION PROCEDURES

TE Connectivity recommends that a maintenance and inspection program be performed periodically to ensure dependable and uniform terminations. Inspect dies at least once a month. Frequency of inspection may be adjusted to suit your requirements through experience. Frequency of inspection is dependent upon:

- Care, amount of use, and handling of the dies
- Skill level of the operator
- Presence of abnormal amounts of dirt and dirt
- Type and size of products being crimped
- Your own established standards

All dies are thoroughly inspected prior to shipment. Because of the possibility of damage during shipment, new dies should be inspected in accordance with instructions in Section 4 when the dies are received in your plant.

4.1. Cleaning



CAUTION

Do NOT allow deposits of dirt, grease, and foreign matter to accumulate in the die closure surfaces. These deposits may cause excessive wear in the die closure surfaces, thereby affecting the quality of the crimp. Wipe dies frequently with a clean, dry cloth.

4.2. Visual Inspection

Visually inspect die closure surfaces for broken, pitted, or chipped areas. Although dies may gage within permissible limits, worn or damaged die closure surfaces are objectionable and can affect crimp quality. Examples of possible damage to die closure surfaces are shown in Figure 6.

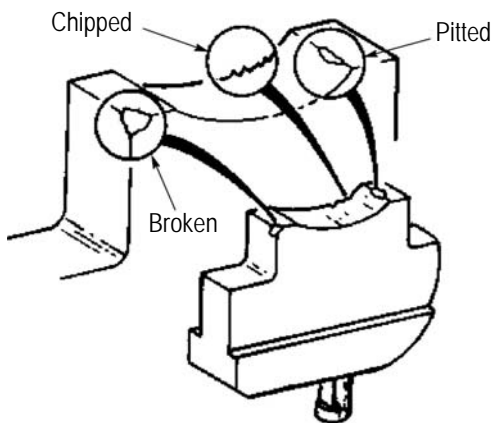
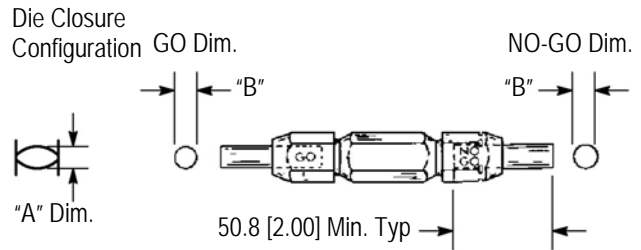

Figure 6

4.3. Die Closure Inspection

Every die set is inspected for proper die closure before shipment. However, inspection of die closure for excessive wear is required periodically.

Suggested Plug Gage Design



DIE SET NO.	DIE CLOSURE DIM "A"†		GAGE MEMBER‡ DIM "B"	
	GO	NO-GO	GO	NO-GO
68200-1	7.544 [.2970]	7.798 [.3070]	7.544-7.551 [.2970-.2973]	7.795-7.798 [.3069-.3070]
68201-1	8.534 [.3360]	8.738 [.3440]	8.534-8.542 [.3360-.3363]	8.730-8.738 [.3437-.3440]
68203-1	11.506 [.4530]	11.760 [.4630]	11.506-11.514 [.4530-.4533]	11.758-11.760 [.4629-.4630]
68204-1	13.564 [.5340]	13.818 [.5440]	13.564-13.571 [.5340-.5343]	13.815-13.818 [.5439-.5440]
68332-1	15.037 [.5920]	15.291 [.6020]	15.037-15.044 [.5920-.5923]	15.288-15.291 [.6019-.6020]
68206-1	16.612 [.6540]	16.866 [.6640]	16.612-16.619 [.6540-.6543]	16.863-16.866 [.6639-.6640]
46757-3	17.856 [.7030]	18.059 [.7110]	17.856-17.864 [.7030-.7033]	18.052-18.059 [.7107-.7110]
46758-2	19.406 [.7640]	19.660 [.7740]	19.406-19.413 [.7640-.7643]	19.657-19.660 [.7739-.7740]

†Die closure dimensions apply when dies are positioned at "gage dimension" indicated in Figure 8, Detail A. ‡Material - Tool Steel.

Figure 7

Die closure inspection is accomplished using GO/NO-GO plug gages. TE neither manufactures nor sells plug gages. A suggested plug gage design and the GO/NO-GO dimensions for plug gage members are given in Figure 7. The following procedure is recommended for inspection the die closure.

1. Clean oil and dirt from the die closure surfaces, and plug gage members.
2. Assemble and adjust the dies to meet the "gage dimension" indicated in Figure 8, Detail A.
3. With the dies positioned at "gage dimension", inspect the die closure using the proper plug gage. Hold the gage in alignment with the die closure and carefully insert, without forcing, the GO member. See Figure 8. GO member must pass completely through the die closure as shown in Figure 8, Detail B.
4. Try to insert the NO-GO member. NO-GO member may enter partially, but must not pass completely through the die closure. See Figure 8, Detail B.

Inspection of Crimping Die Closure

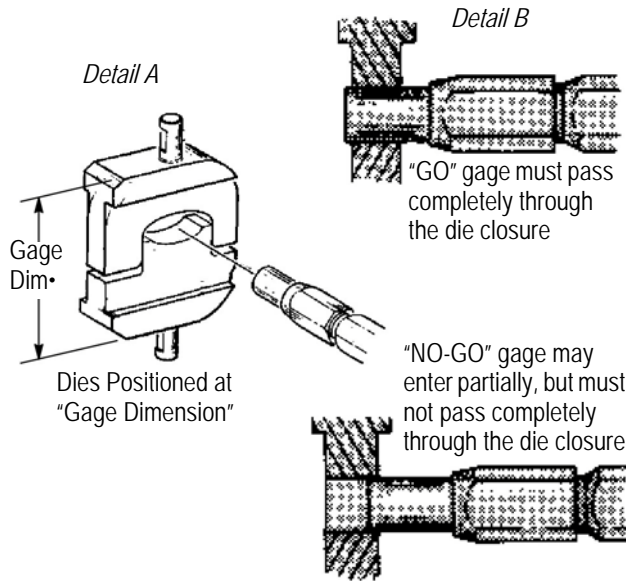

•42.27 mm [1.664 in.] for Dies Used in Tool No. 69009 and 1752868-1
74.30 mm [2.925 in.] for Dies Used in Tool No. 69082 and 1752786-1

Figure 8

5. If the die closure meets the GO/NO-GO gage conditions, the die closure is considered

dimensionally correct. If the die closure does not conform with the GO/NO-GO gage conditions, contact your local TE Representative.

4.4. Replacement Parts

The crimping dies are not repairable. It may be advantageous to stock replacement dies to prevent loss of production time. Figure 9 lists replacement dies that can be purchased from TE.

Order additional crimping dies through your local TE Representative, or call 1-800-526-5142, or send a facsimile of your purchase order to 717-986-7605, or write to:

CUSTOMER SERVICE (038-035)
TYCO ELECTRONICS CORPORATION
PO BOX 3608
HARRISBURG PA 17105-3608

5. REVISION SUMMARY

- Updated document to corporate requirements
- Added 777 MCM nomenclature to Section 1, NOTE in Paragraph 2.1.6, 2.3.D, Figures 2, 4, 5, and 9
- Added new dies to tables in Figures 1, 2, 7, and 9
- Added new NOTE to Paragraph 2.3.D.5

1/0 Thru 400 MCM Dies

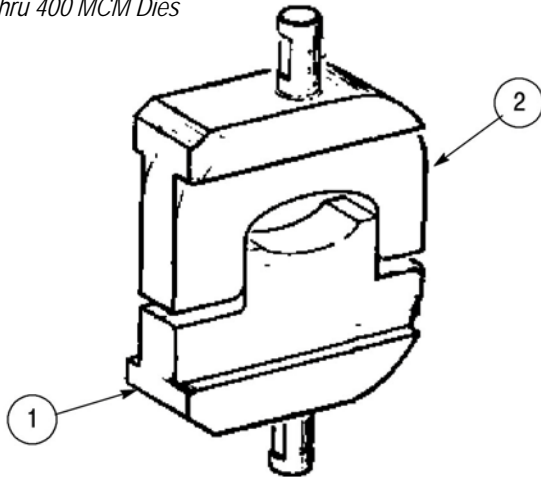

500 Thru 777 MCM Dies

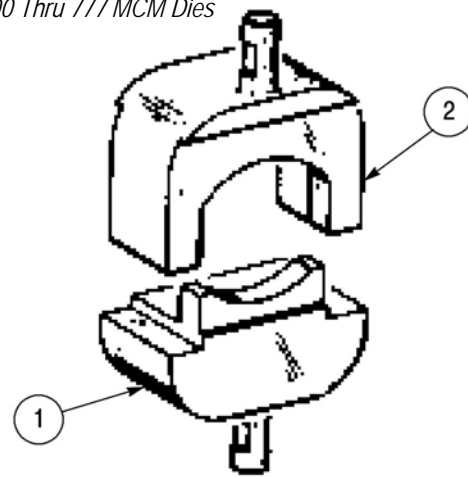

ITEM NO.	DESC	DIE SET NUMBER AND COMPONENT PART NUMBERS								
		68200-1	68201-1	68203-1	68204-1	68206-1	68332-1	46757-3	46758-2	46758-3
1	Moving Die	311565-1	311565-2	311565-3	311565-4	311565-6	311565-5	1-45835-1	1-305687-0	5-305687-7
2	Stationary Die	1-307719-5	1-307719-6	1-307719-8	2-45830-0	45834-8	2-45830-2	305687-9	1-305688-0	1-305688-0

Figure 9