

### FEATURES:

- 128k x 8-bit EEPROM
- RAD-PAK<sup>®</sup> radiation-hardened against natural space radiation
- Total dose hardness:
  - > 100 krad (Si), depending upon space mission
- Excellent Single event effects
  - $SEL_{TH} > 120 \text{ MeV/mg/cm}^2$
  - $SEU > 90 \text{ MeV/mg/cm}^2$  read mode
  - $SEU = 18 \text{ MeV/mg/cm}^2$  write mode
- Package:
  - 32-pin RAD-PAK<sup>®</sup> flat pack/DIP package
  - JEDEC-approved byte-wide pinout
- High speed:
  - 120, 150, and 200 ns maximum access times available
- High endurance:
  - 10,000 erase/write (in Page Mode),
  - 10 year data retention
- Page write mode:
  - 1 to 128 bytes
- Low power dissipation
  - 20 mW/MHz active (typical)
  - 110  $\mu\text{W}$  standby (maximum)
- Standard JEDEC package width

### DESCRIPTION:

Maxwell Technologies' 28C010T high-density 1 Megabit (128K x 8-Bit) EEPROM microcircuit features a greater than 100 krad (Si) total dose tolerance, depending upon space mission. The 28C010T is capable of in-system electrical byte and page programmability. It has a 128-byte page programming function to make its erase and write operations faster. It also features data polling and a Ready/Busy signal to indicate the completion of erase and programming operations. In the 28C010T, hardware data protection is provided with the  $\overline{RES}$  pin, in addition to noise protection on the  $\overline{WE}$  signal and write inhibit on power on and off. Software data protection is implemented using the JEDEC optional standard algorithm.

Maxwell Technologies' patented RAD-PAK<sup>®</sup> packaging technology incorporates radiation shielding in the microcircuit package. It eliminates the need for box shielding while providing the required radiation shielding for a lifetime in orbit or space mission. In a GEO orbit, RAD-PAK<sup>®</sup> provides greater than 100 krad(Si) radiation dose tolerance. This product is available with screening up to Class S.

TABLE 1. 28C010T PINOUT DESCRIPTION

PIN	SYMBOL	DESCRIPTION
12-5, 27, 26, 23, 25, 4, 28, 3, 31, 2	A0-A16	Address
13, 14, 15, 17, 18, 19, 20, 21	I/O0 - I/O7	Data I/O
24	$\overline{OE}$	Output Enable
22	$\overline{CE}$	Chip Enable
29	$\overline{WE}$	Write Enable
32	V <sub>CC</sub>	Power Supply
16	V <sub>SS</sub>	Ground
1	RDY/BUSY	Ready/Busy
30	RES	Reset

TABLE 2. 28C010T ABSOLUTE MAXIMUM RATINGS

PARAMETER	SYMBOL	MIN	TYP	MAX	UNITS
Supply Voltage (Relative to V <sub>SS</sub> )	V <sub>CC</sub>	-0.6		+7.0	V
Input Voltage (Relative to V <sub>SS</sub> )	V <sub>IN</sub>	-0.5 <sup>1</sup>		+7.0	V
Package Weight	RP		7.4		Grams
	RT		2.7		
	RD		10.9		
Thermal Impedance (RP and RT Packages)	$\Phi_{JC}$		2.4		°C/W
Thermal Impedance (DIP Package)	$\Phi_{JC}$		2.17		°C/W
Operating Temperature Range	T <sub>OPR</sub>	-55		+125	°C
Storage Temperature Range	T <sub>STG</sub>	-65		+150	°C

1. V<sub>IN</sub> min = -3.0V for pulse width ≤ 50ns.

TABLE 3. DELTA LIMITS<sup>1</sup>

PARAMETER	VARIATION <sup>2</sup>
I <sub>CC1</sub>	±10%
I <sub>CC2</sub>	±10%
I <sub>CC3A</sub>	±10%
I <sub>CC3B</sub>	±10%

1. Parameters are measured and recorded as Deltas per MIL-STD-883 for Class S Devices

2. Specified in Table 6

TABLE 4. 28C010T RECOMMENDED OPERATING CONDITIONS

PARAMETER	SYMBOL	MIN	MAX	UNITS
Supply Voltage	$V_{CC}$	4.5	5.5	V
Input Voltage  $\overline{RES\_PIN}$	$V_{IL}$	-0.3 <sup>1</sup>	0.8	V
	$V_{IH}$	2.2	$V_{CC} + 0.3$	
	$V_H$	$V_{CC} - 0.5$	$V_{CC} + 1$	

1.  $V_{IL}$  min = -1.0V for pulse width  $\leq$  50 ns

TABLE 5. 28C010T CAPACITANCE  
( $T_A = 25^\circ\text{C}$ ,  $f = 1\text{ MHz}$ )

PARAMETER	SYMBOL	MIN	MAX	UNITS
Input Capacitance: $V_{IN} = 0V$ <sup>1</sup>	$C_{IN}$	--	6	pF
Output Capacitance: $V_{OUT} = 0V$ <sup>1</sup>	$C_{OUT}$	--	12	pF

1. Guaranteed by design.

TABLE 6. 28C010T DC ELECTRICAL CHARACTERISTICS  
( $V_{CC} = 5V \pm 10\%$ ,  $T_A = -55$  TO  $+125^\circ\text{C}$ , UNLESS OTHERWISE SPECIFIED)

PARAMETER	TEST CONDITION	SUBGROUPS	SYMBOL	MIN	MAX	UNITS
Input Leakage Current	$V_{CC} = 5.5V$ , $V_{IN} = 5.5V$	1, 2, 3	$I_{IL}$	--	2 <sup>1</sup>	$\mu\text{A}$
Output Leakage Current	$V_{CC} = 5.5V$ , $V_{OUT} = 5.5V/0.4V$	1, 2, 3	$I_{LO}$	--	2	$\mu\text{A}$
Standby $V_{CC}$ Current	$\overline{CE} = V_{CC}$	1, 2, 3	$I_{CC1}$	--	20	$\mu\text{A}$
	$\overline{CE} = V_{IH}$		$I_{CC2}$	--	1	mA
Operating $V_{CC}$ Current	$I_{OUT} = 0\text{mA}$ , Duty = 100%, Cycle = $1\mu\text{s}$ at $V_{CC} = 5.5V$	1, 2, 3	$I_{CC3A}$	--	15	mA
	$I_{OUT} = 0\text{mA}$ , Duty = 100%, Cycle = 150ns at $V_{CC} = 5.5V$	1, 2, 3	$I_{CC3B}$	--	50	
Input Voltage  $\overline{RES\_PIN}$		1, 2, 3	$V_{IL}$	--	0.8	V
			$V_{IH}$	2.2	--	
			$V_H$	$V_{CC} - 0.5$	--	
Output Voltage <sup>2</sup>	$I_{OL} = 2.1\text{ mA}$	1, 2, 3	$V_{OL}$	--	0.4	V
	$I_{OH} = -0.4\text{ mA}$		$V_{OH}$	2.4	--	
	$I_{OH} = -0.1\text{ mA}$		$V_{OH}$	$V_{CC} - 0.3V$	--	

1.  $I_{IL}$  for RES = 100uA max.

2. RDY/BSY is an open drain output. Only  $V_{OL}$  applies to this pin.

TABLE 7. 28C010T AC ELECTRICAL CHARACTERISTICS FOR READ OPERATION <sup>1</sup>  
 ( $V_{CC} = 5V \pm 10\%$ ,  $T_A = -55$  TO  $+125$  °C)

PARAMETER	SYMBOL	SUBGROUPS	MIN	MAX	UNITS
Address Access Time $\overline{CE} = \overline{OE} = V_{IL}, \overline{WE} = V_{IH}$ -120 -150 -200	$t_{ACC}$	9, 10, 11	-- -- --	120 150 200	ns
Chip Enable Access Time $\overline{OE} = V_{IL}, \overline{WE} = V_{IH}$ -120 -150 -200	$t_{CE}$	9, 10, 11	-- -- --	120 150 200	ns
Output Enable Access Time $\overline{CE} = V_{IL}, \overline{WE} = V_{IH}$ -120 -150 -200	$t_{OE}$	9, 10, 11	0 0 0	75 75 100	ns
Output Hold to Address Change $\overline{CE} = \overline{OE} = V_{IL}, \overline{WE} = V_{IH}$ -120 -150 -200	$t_{OH}$	9, 10, 11	0 0 0	-- -- --	ns
Output Disable to High-Z <sup>2</sup> $\overline{CE} = V_{IL}, \overline{WE} = V_{IH}$ -120 -150 -200 $\overline{CE} = \overline{OE} = V_{IL}, \overline{WE} = V_{IH}$ -120 -150 -200	$t_{DF}$  $t_{DFR}$	9, 10, 11	0 0 0 0 0 0	50 50 60 300 350 450	ns
RES to Output Delay <sup>3</sup> $\overline{CE} = \overline{OE} = V_{IL}, \overline{WE} = V_{IH}$ -120 -150 -200	$t_{RR}$	9, 10, 11	-- -- --	400 450 650	ns

1. Test conditions: Input pulse levels - 0.4V to 2.4V; input rise and fall times < 20ns; output load - 1 TTL gate + 100pF (including scope and jig); reference levels for measuring timing - 0.8V/1.8V.
2.  $t_{DF}$  and  $t_{DFR}$  are defined as the time at which the output becomes an open circuit and data is no longer driven.
3. Guaranteed by design.

TABLE 8. 28C010T AC ELECTRICAL CHARACTERISTICS FOR  
PAGE/BYTE ERASE AND PAGE/BYTE WRITE OPERATIONS

( $V_{CC} = 5V \pm 10\%$ ,  $T_A = -55$  TO  $+125$  °C)

PARAMETER	SYMBOL	SUBGROUPS	MIN <sup>1</sup>	MAX	UNITS
Address Setup Time -120 -150 -200	$t_{AS}$	9, 10, 11	0 0 0	-- -- --	ns
Chip Enable to Write Setup Time ( $\overline{WE}$ controlled) -120 -150 -200	$t_{CS}$	9, 10, 11	0 0 0	-- -- --	ns
Write Pulse Width CE controlled -120 -150 -200 WE controlled -120 -150 -200	$t_{CW}$    $t_{WP}$	9, 10, 11	   200 250 350  200 250 350	   -- -- --  -- -- --	ns
Address Hold Time -120 -150 -200	$t_{AH}$	9, 10, 11	150 150 200	-- -- --	ns
Data Setup Time -120 -150 -200	$t_{DS}$	9, 10, 11	75 100 150	-- -- --	ns
Data Hold Time -120 -150 -200	$t_{DH}$	9, 10, 11	10 10 10	-- -- --	ns
Chip Enable Hold Time ( $\overline{WE}$ controlled) -120 -150 -2000	$t_{CH}$	9, 10, 11	0 0 0	-- -- --	ns
Write Enable to Write Setup Time ( $\overline{CE}$ controlled) -120 -150 -200	$t_{WS}$	9, 10, 11	0 0 0	-- -- --	ns
Write Enable Hold Time ( $\overline{CE}$ controlled) -120 -150 -200	$t_{WH}$	9, 10, 11	0 0 0	-- -- --	ns

TABLE 8. 28C010T AC ELECTRICAL CHARACTERISTICS FOR  
PAGE/BYTE ERASE AND PAGE/BYTE WRITE OPERATIONS  
( $V_{CC} = 5V \pm 10\%$ ,  $T_A = -55$  TO  $+125$  °C)

PARAMETER	SYMBOL	SUBGROUPS	MIN <sup>1</sup>	MAX	UNITS
Output Enable to Write Setup Time -120 -150 -200	$t_{OES}$	9, 10, 11	0 0 0	-- -- --	ns
Output Enable Hold Time -120 -150 -200	$t_{OEH}$	9, 10, 11	0 0 0	-- -- --	ns
Write Cycle Time <sup>2</sup> -120 -150 -200	$t_{WC}$	9, 10, 11	-- -- --	10 10 10	ms
Data Latch Time -120 -150 -200	$t_{DL}$	9, 10, 11	250 300 400	-- -- --	ns
Byte Load Window -120 -150 -200	$t_{BL}$	9, 10, 11	100 100 200	-- -- --	$\mu$ s
Byte Load Cycle -120 -150 -200	$t_{BLC}$	9, 10, 11	0.55 0.55 0.95	30 30 30	$\mu$ s
Time to Device Busy -120 -150 -200	$t_{DB}$	9, 10, 11	100 120 170	-- -- --	ns
Write Start Time <sup>3</sup> -120 -150 -200	$t_{DW}$	9, 10, 11	150 150 250	-- -- --	ns
RES to Write Setup Time <sup>4</sup> -120 -150 -200	$t_{RP}$	9, 10, 11	100 100 200	-- -- --	$\mu$ s
$V_{CC}$ to RES Setup Time <sup>4</sup> -120 -150 -200	$t_{RES}$	9, 10, 11	1 1 3	-- -- --	$\mu$ s

1. Use this device in a longer cycle than this value.

2.  $t_{WC}$  must be longer than this value unless polling techniques or RDY/BUSY are used. This device automatically completes the internal write operation within this value.
3. Next read or write operation can be initiated after  $t_{DW}$  if polling techniques or RDY/BUSY are used.
4. Guaranteed by design.

TABLE 9. 28C010T MODE SELECTION <sup>1</sup>

PARAMETER	$\overline{CE}$	$\overline{OE}$	$\overline{WE}$	I/O	$\overline{RES}$	RDY/BUSY
Read	$V_{IL}$	$V_{IL}$	$V_{IH}$	$D_{OUT}$	$V_H$	High-Z
Standby	$V_{IH}$	X	X	High-Z	X	High-Z
Write	$V_{IL}$	$V_{IH}$	$V_{IL}$	$D_{IN}$	$V_H$	High-Z --> $V_{OL}$
Deselect	$V_{IL}$	$V_{IH}$	$V_{IH}$	High-Z	$V_H$	High-Z
Write Inhibit	X	X	$V_{IH}$	--	X	--
	X	$V_{IL}$	X	--	X	--
Data Polling	$V_{IL}$	$V_{IL}$	$V_{IH}$	Data Out (I/O)	$V_H$	$V_{OL}$
Program	X	X	X	High-Z	$V_{IL}$	High-Z

1. X = Don't care.

FIGURE 1. READ TIMING WAVEFORM

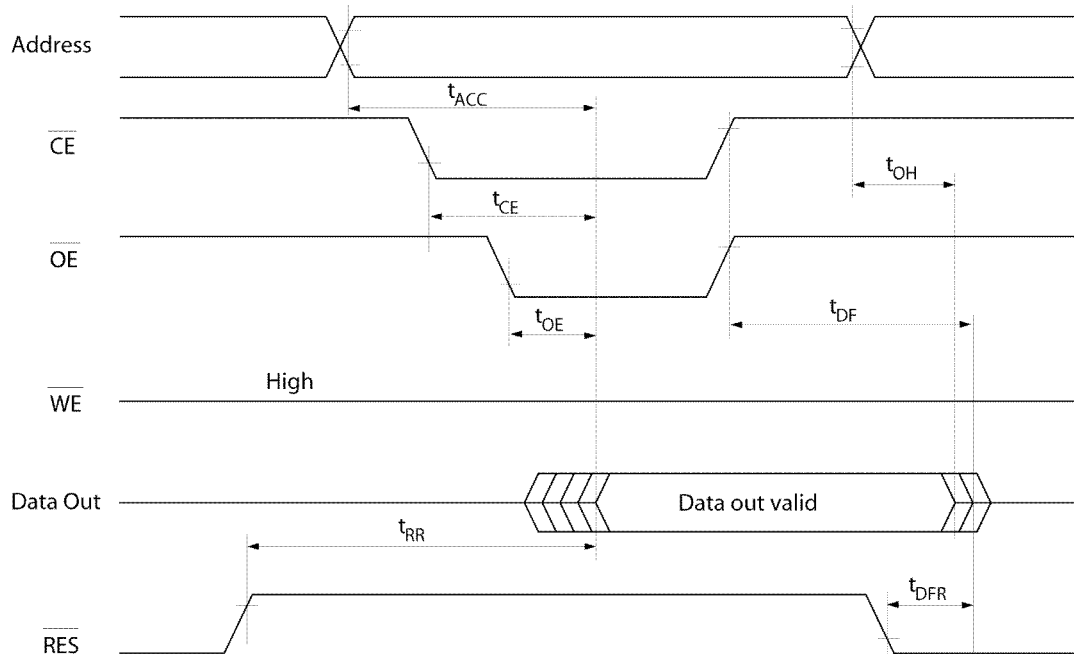

FIGURE 2. BYTE WRITE TIMING WAVEFORM(1) ( $\overline{WE}$  CONTROLLED)

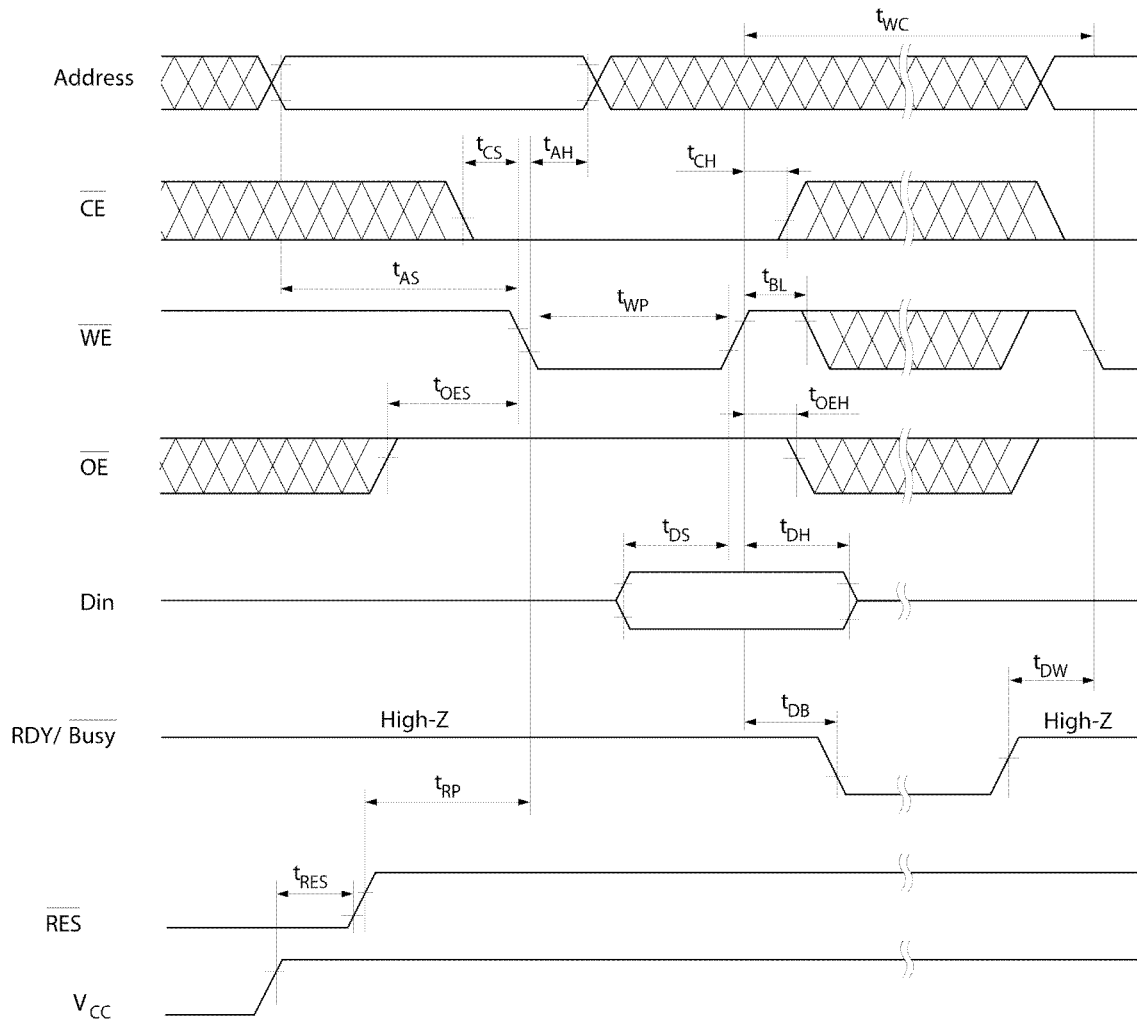



FIGURE 3. BYTE WRITE TIMING WAVEFORM (2) ( $\overline{CE}$  CONTROLLED)

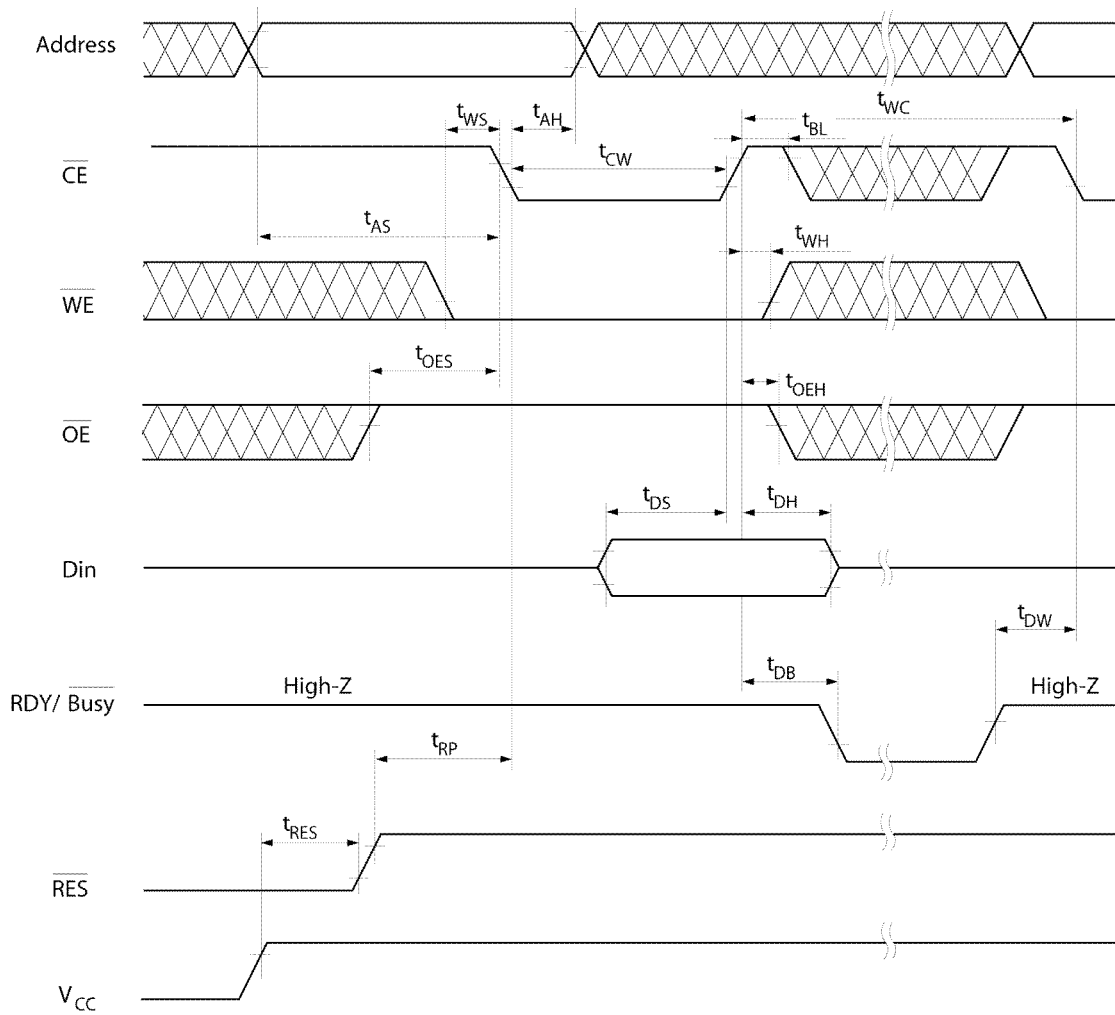

FIGURE 4. PAGE WRITE TIMING WAVEFORM(1) ( $\overline{WE}$  CONTROLLED)

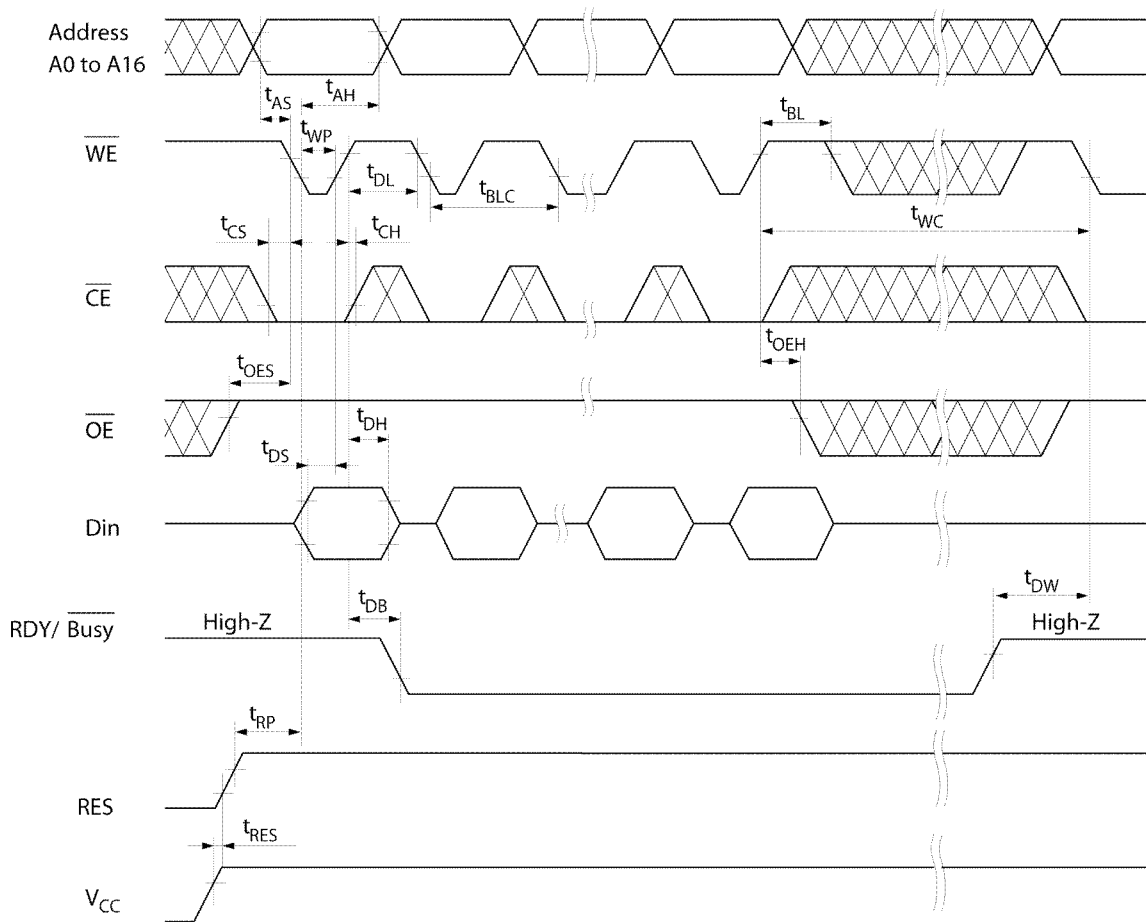

FIGURE 5. PAGE WRITE TIMING WAVEFORM(2) ( $\overline{CE}$  CONTROLLED)

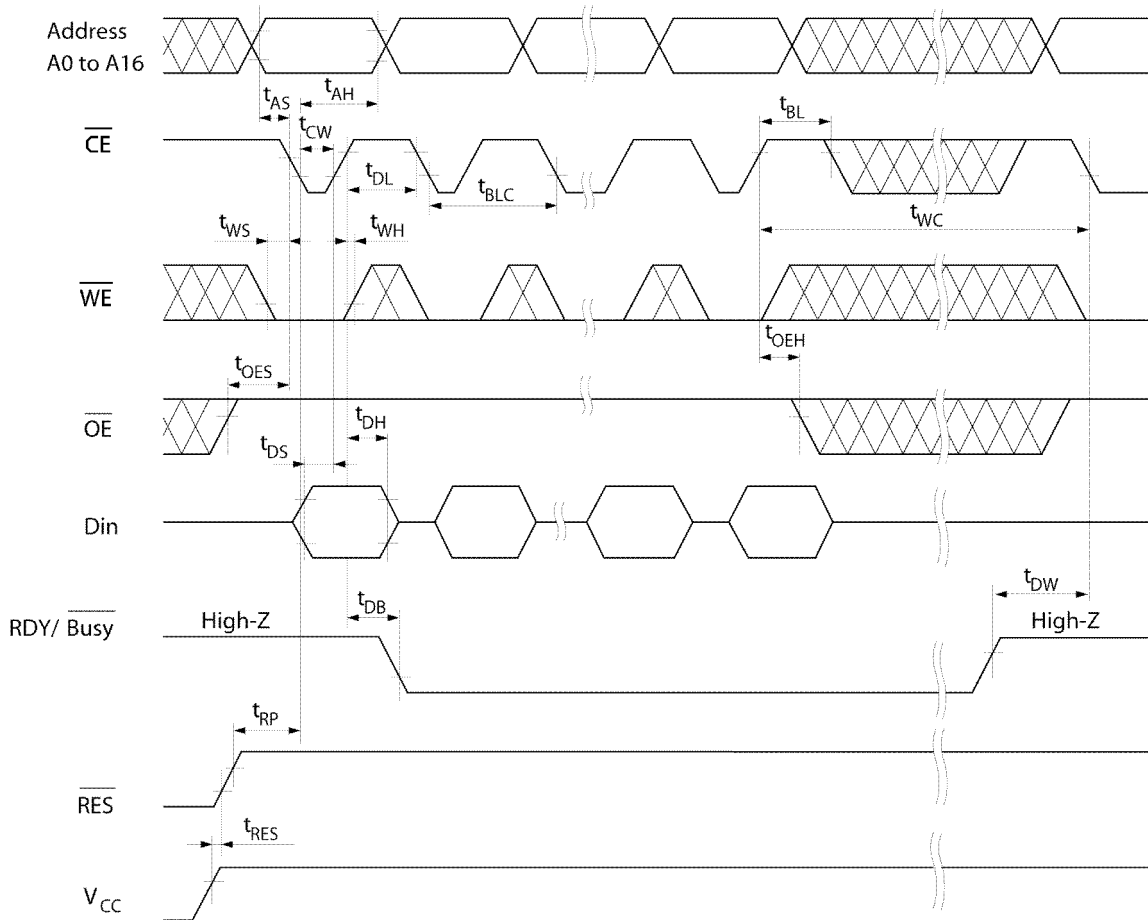

FIGURE 6. DATA POLLING TIMING WAVEFORM

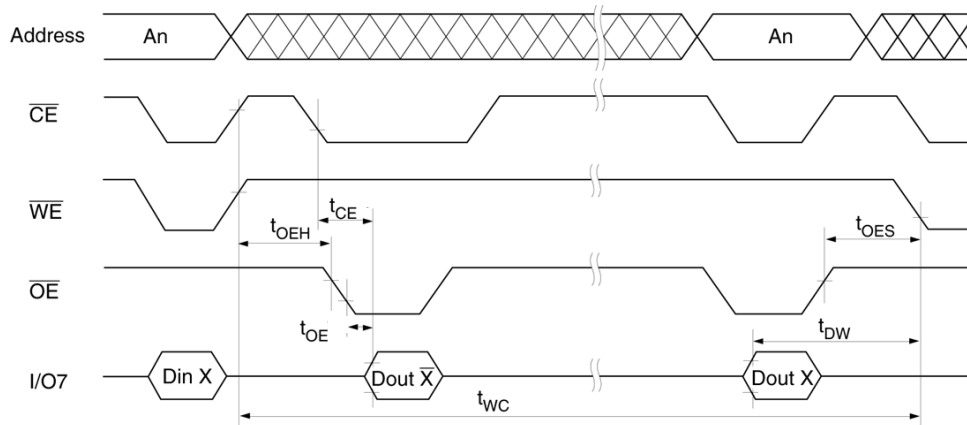

FIGURE 7. SOFTWARE DATA PROTECTION TIMING WAVEFORM(1) (ENABLE S/W PROTECTION)

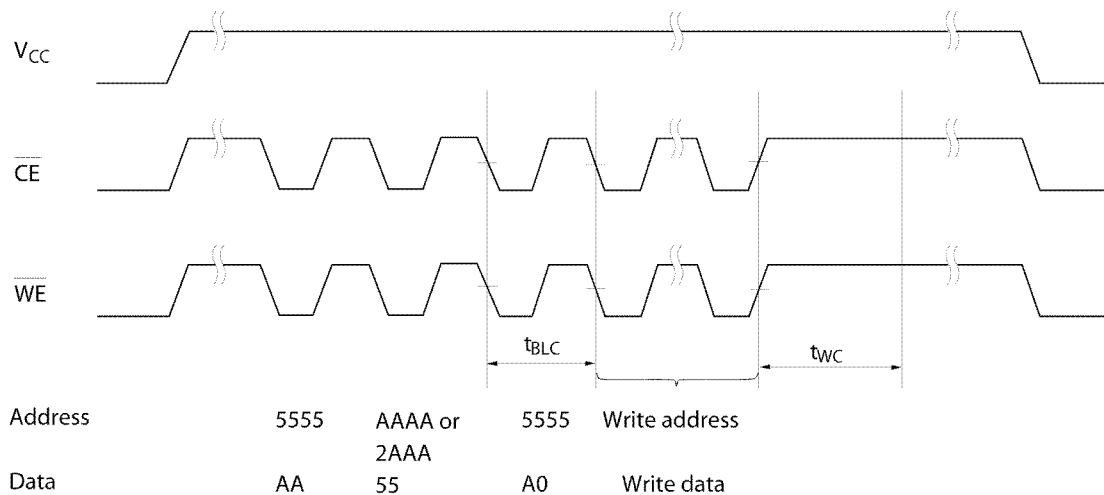
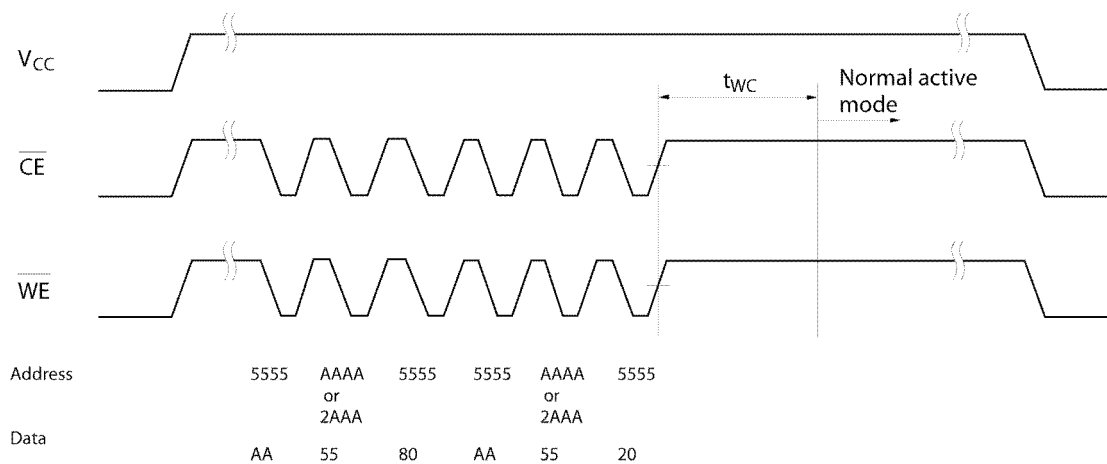

FIGURE 8. SOFTWARE DATA PROTECTION TIMING WAVEFORM(2) (DISABLE S/W PROTECTION)



## EEPROM APPLICATION NOTES

This application note describes the programming procedures for the EEPROM modules and with details of various techniques to preserve data protection.

### Automatic Page Write

Page-mode write feature allows 1 to 128 bytes of data to be written into the EEPROM in a single write cycle, and allows the undefined data within 128 bytes to be written corresponding to the undefined address (A0 to A6). Loading the first byte of data, the data load window opens 30µs for the second byte. In the same manner each additional byte of data can be loaded within 30µs. In case CE and WE are kept high for 100 µs after data input, EEPROM enters erase and write mode automatically and only the input data are written into the EEPROM.

## $\overline{WE}$ , $\overline{CE}$ Pin Operation

During a write cycle, addresses are latched by the falling edge of  $\overline{WE}$  or  $\overline{CE}$ , and data is latched by the rising edge of  $\overline{WE}$  or  $\overline{CE}$ .

## Data Polling

Data Polling function allows the status of the EEPROM to be determined. If EEPROM is set to read mode during a write cycle, an inversion of the last byte of data to be loaded outputs from I/O 7 to indicate that the EEPROM is performing a write operation.

## RDY/ $\overline{Busy}$ Signal

RDY/ $\overline{Busy}$  signal also allows a comparison operation to determine the status of the EEPROM. The RDY/ $\overline{Busy}$  signal has high impedance except in write cycle and is lowered to  $V_{OL}$  after the first write signal. At the end of a write cycle, the RDY/ $\overline{Busy}$  signal changes state to high impedance.

## $\overline{RES}$ Signal

When  $\overline{RES}$  is LOW, the EEPROM cannot be read and programmed. Therefore, data can be protected by keeping  $\overline{RES}$  low when  $V_{CC}$  is switched.  $\overline{RES}$  should be high during read and programming because it doesn't provide a latch function.

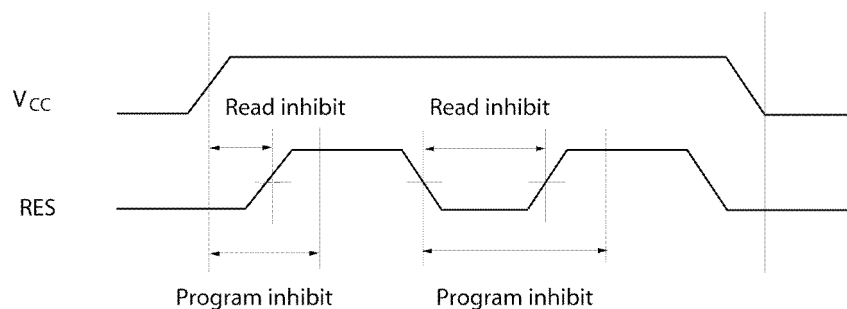

## Data Protection

To protect the data during operation and power on/off, the EEPROM has the internal functions described below.

1. Data Protection against Noise of Control Pins ( $\overline{CE}$ ,  $\overline{OE}$ ,  $\overline{WE}$ ) during Operation.

During readout or standby, noise on the control pins may act as a trigger and turn the EEPROM to programming mode by mistake. To prevent this phenomenon, the EEPROM has a noise cancellation function that cuts noise if its width is 20ns or less in programming mode. Be careful not to allow noise of a width of more than 20ns on the control pins.

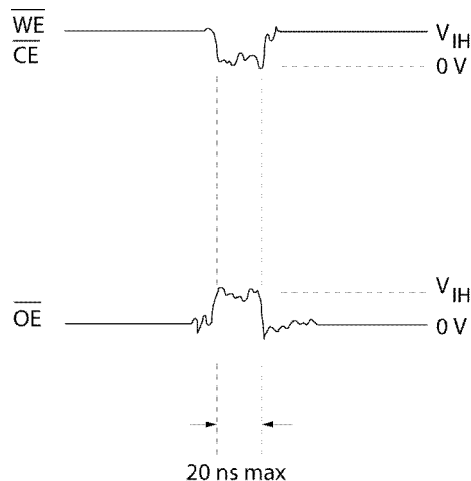

## 2. Data Protection at $V_{CC}$ on/off

When  $V_{CC}$  is turned on or off, noise on the control pins generated by external circuits, such as CPUs, may turn the EEPROM to programming mode by mistake. To prevent this unintentional programming, the EEPROM must be kept in unprogrammable state during  $V_{CC}$  on/off by using a CPU reset signal to  $\overline{RES}$  pin.

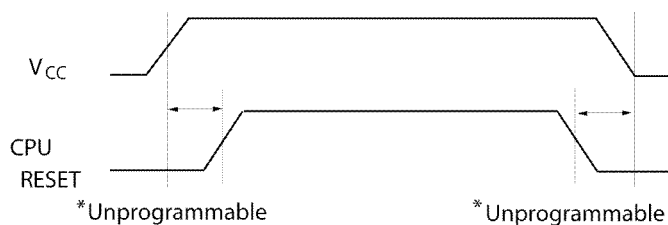

$\overline{RES}$  should be kept at  $V_{SS}$  level when  $V_{CC}$  is turned on or off. The EEPROM breaks off programming operation when  $\overline{RES}$  become low, programming operation doesn't finish correctly in case that  $\overline{RES}$  falls low during programming operation.  $\overline{RES}$  should be kept high for 10 ms after the last data input.

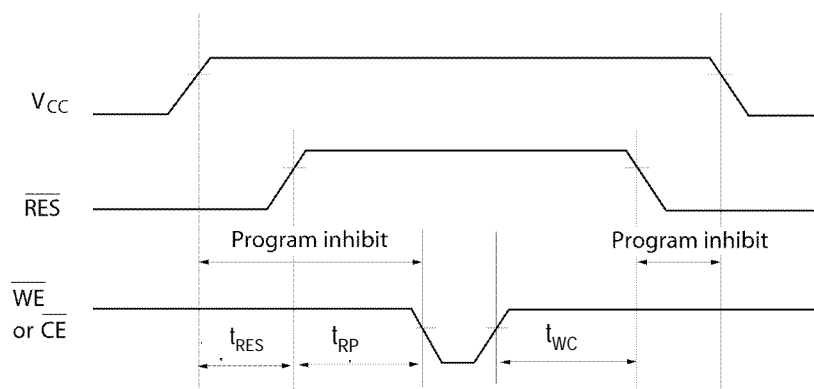

## 3. Software Data Protection

The software data protection function is to prevent unintentional programming caused by noise generated by external circuits. In software data protection mode, 3 bytes of data must be input before write data as follows. These bytes can switch the non-protection mode to the protection mode.

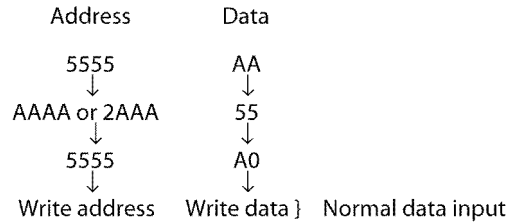

Software data protection mode can be canceled by inputting the following 6 bytes. Then, the EEPROM turns to the non-protection mode and can write data normally. However, when the data is input in the canceling cycle, the data cannot be written.

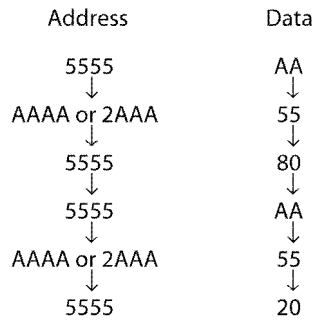





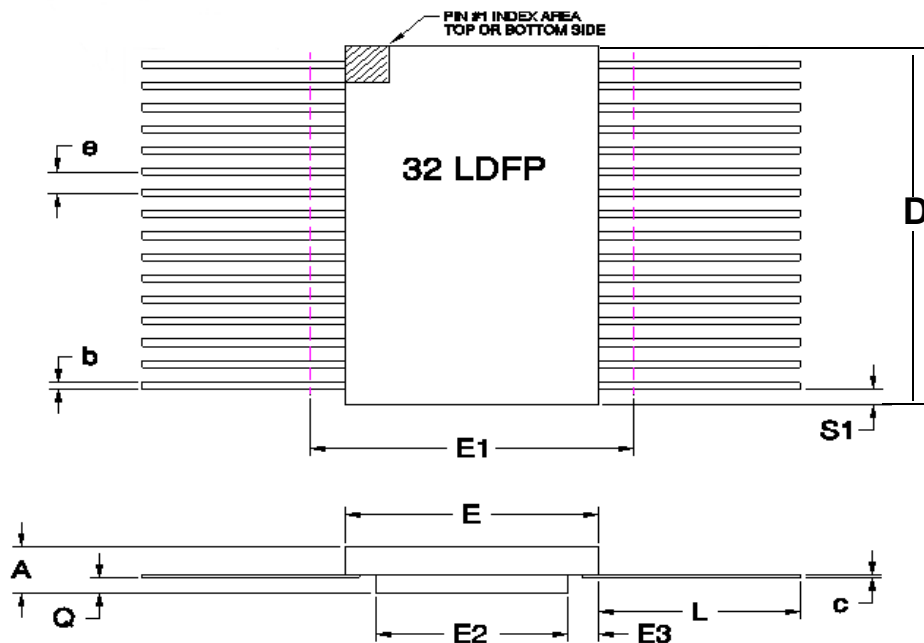

28C010T 32-PIN RAD-PAK® FLAT PACKAGE

SYMBOL	DIMENSION		
	MIN	NOM	MAX
A	0.121	0.134	0.147
b	0.015	0.017	0.022
c	0.004	0.005	0.009
D	--	0.820	0.830
E	0.472	0.480	0.488
E1	--	--	0.498
E2	0.304	0.310	--
E3	0.030	0.085	--
e	0.050BSC		
L	0.355	0.365	0.375
Q	0.020	0.035	0.045
S1	0.005	0.027	--
N	32		

Note: All dimensions in inches.

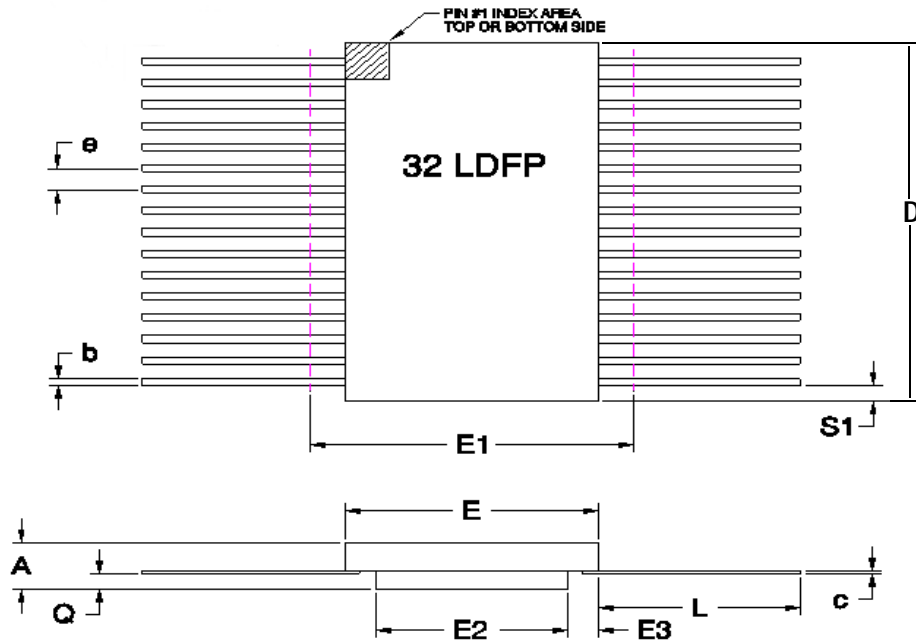

28C010T Rad-Tolerant Flat Package

SYMBOL	DIMENSION		
	MIN	NOM	MAX
A	0.095	0.109	0.125
b	0.015	0.017	0.022
c	0.004	0.005	0.009
D	--	0.820	0.830
E	0.472	0.480	0.488
E1	--	--	0.498
E2	0.350	0.365	--
E3	0.030	0.085	--
e	0.050BSC		
L	0.355	0.365	0.375
Q	0.020	0.035	0.045
S1	0.005	0.027	--
N	32		

Note: All Dimentions in Inches

## Important Notice:

These data sheets are created using the chip manufacturers published specifications. Maxwell Technologies verifies functionality by testing key parameters either by 100% testing, sample testing or characterization.

The specifications presented within these data sheets represent the latest and most accurate information available to date. However, these specifications are subject to change without notice and Maxwell Technologies assumes no responsibility for the use of this information.

Maxwell Technologies' products are not authorized for use as critical components in life support devices or systems without express written approval from Maxwell Technologies.

Any claim against Maxwell Technologies must be made within 90 days from the date of shipment from Maxwell Technologies. Maxwell Technologies' liability shall be limited to replacement of defective parts.

# 1 Megabit (128K x 8-Bit) EEPROM

# 28C010T

## Product Ordering Options

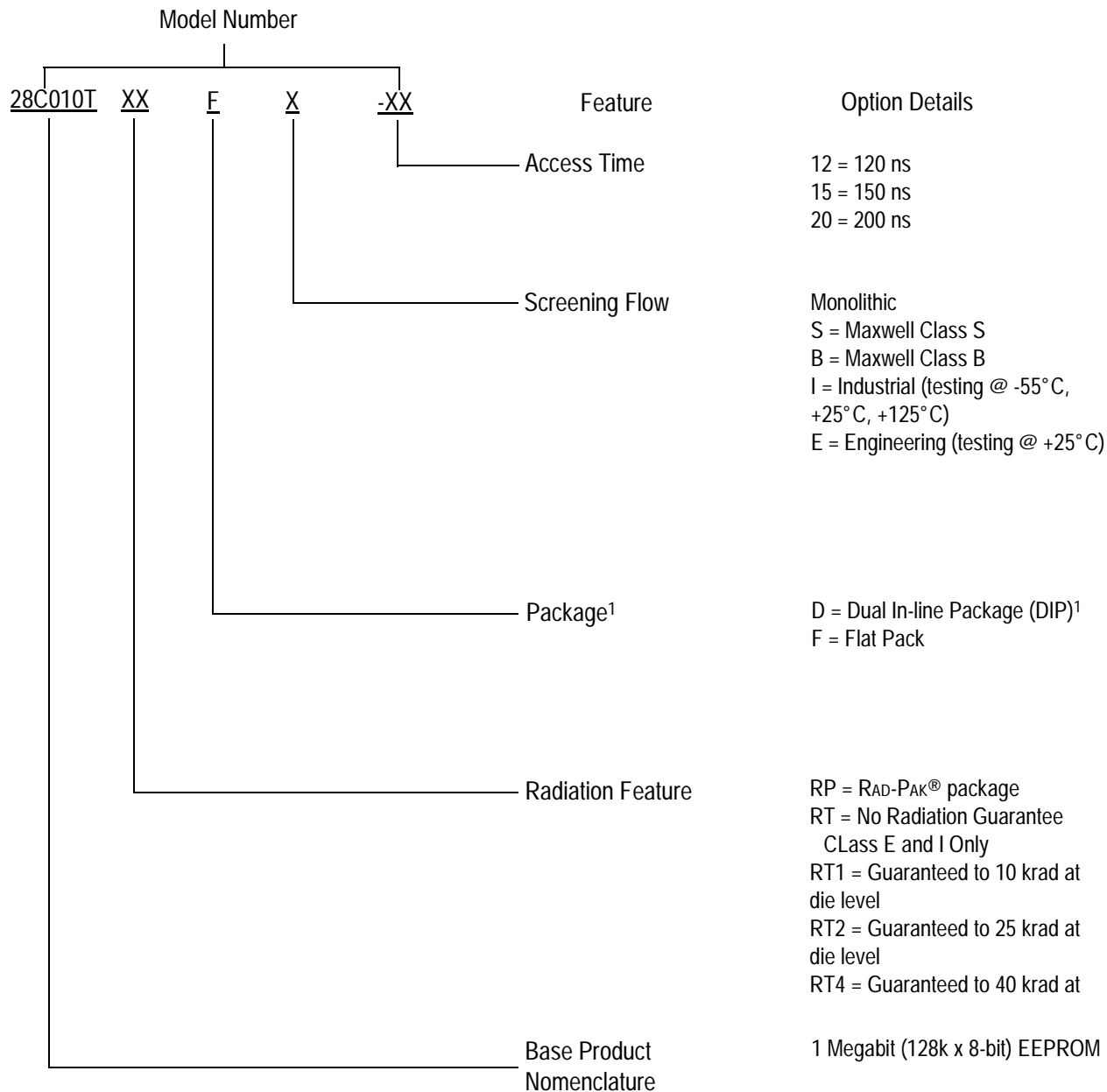

<sup>1</sup>) Standard Product Screening Flow MIL-STD-883, Method 2001, Constant Acceleration :For DIP package type Constant Acceleration is 3000g's.