

Data sheet | Item number: 765-4201/100-000

8-Port-IO Link Master Class A; EtherCAT; DC 24 V / 2.0 A; 8xM12 connection; WideLine



www.wago.com/765-4201/100-000



i Picture differs from the item.

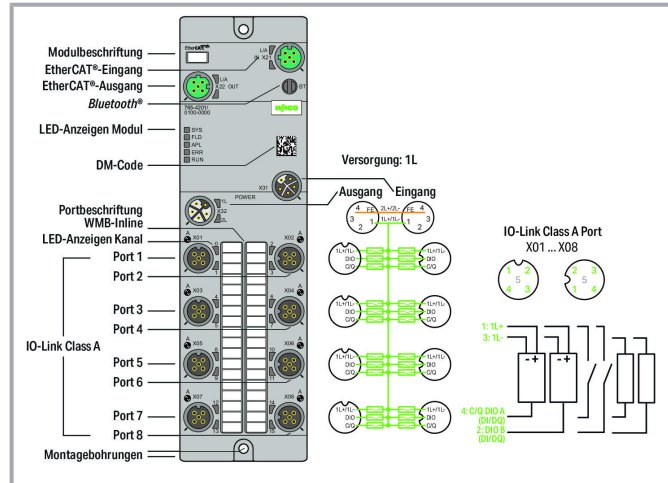

Data

Technical data

Fieldbus

| | |
|---|-------------------------------------|
| Communication | EtherCAT AoE, EoE, FoE |
| Connection technology: communication/fieldbus | 2 x D-coded M12; 4-pole |
| Interface standard | 10BASE-T/100BASE-TX; potential-free |
| Autonegotiation; autocrossover | yes |

Device Functions

| | |
|------------|--------------------------------|
| Parameters | Input filter Output current |
|------------|--------------------------------|

Subject to changes. Please also observe the further product documentation!

WAGO Kontakttechnik GmbH & Co. KG
 Hansastr. 27
 32423 Minden
 Phone: +49571 887-0 | Fax: +49571 887-169
 Email: info.de@wago.com | Web: www.wago.com

Do you have any questions about our products?
 We are always happy to take your call at +49 (571) 887-44222.



| | |
|------------------|--|
| | Temperature |
| Diagnostics | Undervoltage; Overcurrent; Overload; Overtemperature |
| Device functions | Bluetooth® OPC UA Server |
| Visualization | Android/iOS app Webserver |

IO-Link Master

| | |
|-------------------------------|--|
| IO-Link Master classification | Class A; Specification V1.1 |
| Port mode | IO-Link: autoconfig, manual, tool-based DI DO |
| Cycle time | 400 µs (min.) |
| Operating mode | IO-Link master, DI or DO (adjustable for pin 4 per port); DI or DO (adjustable for pin 2 per port) |

IO-Link ports

| | |
|---------------------------------------|---|
| Number of digital inputs | 16 |
| Number of digital outputs | 16 |
| Connection technology: inputs/outputs | 8 x A-coded M12; 5-pole |
| Voltage signal type | 24 VDC |
| Input characteristic | High-side switching |
| Input filter | 0.2 ... 20 ms |
| Input characteristic | Type 3, per IEC 61131-2 |
| Output current (per channel) | 2 A (typ.) for DO |
| Supply current per port | 1L: 1 A for IO-Link; 4 A (max.) for DIO |

Module Power Supply

| | |
|-------------------------------|--|
| Connection technology: supply | 2 x L-coded M12; 5-pole |
| Supply voltage | 24 VDC (18 ... 31.2 V); 1L |
| Power consumption (max.) | 16000 mA |
| Power consumption (note) | per supply line; overload- and short-circuit-protected |
| Reverse voltage protection | Yes |

Geometrical Data

| | |
|--------|---------------------|
| Width | 60 mm / 2.362 inch |
| Height | 30 mm / 1.181 inch |
| Depth | 210 mm / 8.268 inch |

Subject to changes. Please also observe the further product documentation!

Mechanical Data

| | |
|--------------------|-------|
| Weight | 670 g |
| Conformity marking | CE |

Environmental Requirements



| | |
|--|--|
| Surrounding air temperature (operation) | -25 ... 70 °C |
| Surrounding air temperature (storage) | -40 ... 80 °C |
| Protection type | IP67 |
| Protection class | III per EN 61140, IEC 61140, VDE 0140-1 |
| Operating altitude | 0 ... 2000 m |
| Pollution degree (5) | 3 per EN 60664-1 |
| Overvoltage category | II (EN 60664-1) |
| Relative humidity (without condensation) | 95 % |
| Vibration resistance | 5g per IEC 60068-2-6 |
| Shock resistance | Short-term: 50g/11 ms/half-sine per IEC 60068-2-27; Long-term: 30g/6 ms/half-sine per IEC 60068-2-29 |
| EMC immunity to interference | per EN 61000-6-2 |
| EMC emission of interference | per EN 61000-6-4 |

Commercial data

| | |
|-----------------------|---------------|
| PU (SPU) | 1 Stück |
| Country of origin | DE |
| GTIN | 4055144010152 |
| Customs tariff number | 85371098990 |

Required accessories

Cover

| | | |
|--|---|--|
| Cover | | |
|  | Item no.: 756-8102 M12 protective cap; for unused sockets | www.wago.com/756-8102 |
|  | Item no.: 756-8103 M12 protective cap; for unused plugs | www.wago.com/756-8103 |

Tool

| | | |
|--|--|--|
| Assembly tool | | |
|  | Item no.: 206-701 Torque wrench M8 and M12; Assembly kit | www.wago.com/206-701 |

Subject to changes. Please also observe the further product documentation!

Marking accessories

Marking strip



Item no.: 2009-110

Marking strips; for Smart Printer; on reel; not stretchable; plain; snap-on type; white

www.wago.com/2009-110

Marker



Item no.: 2009-115

WMB-Inline; for Smart Printer; 1500 pieces on roll; stretchable 5 - 5.2 mm; plain; snap-on type; white

www.wago.com/2009-115

Optional accessories

Cables and pluggable connectors

Sensor/actuator cable



Item no.: 756-5402/040-010

Sensor/Actuator cable; M12A socket; straight; M12A plug; angled; 4-pole; Length: 1 m

www.wago.com/756-5402/040-010



Item no.: 756-5402/040-020

Sensor/Actuator cable; M12A socket; straight; M12A plug; angled; 4-pole; Length: 2 m

www.wago.com/756-5402/040-020



Item no.: 756-5311/040-050

Sensor/Actuator cable; M12A plug; straight; 4-pole; Length: 5 m

www.wago.com/756-5311/040-050



Item no.: 756-5311/040-015

Sensor/Actuator cable; M12A plug; straight; 4-pole; Length: 1.5 m

www.wago.com/756-5311/040-015



Item no.: 756-5311/040-100

Sensor/Actuator cable; M12A plug; straight; 4-pole; Length: 10 m

www.wago.com/756-5311/040-100



Item no.: 756-5404/040-020

Sensor/Actuator cable; M12A socket; angled; M12A plug; angled; 4-pole; Length: 2 m

www.wago.com/756-5404/040-020



Item no.: 756-5510/040-010

Sensor/Actuator cable; M8 socket; angled; M12A plug; angled; 4-pole; Length: 1 m

www.wago.com/756-5510/040-010



Item no.: 756-5510/040-020

Sensor/Actuator cable; M8 socket; angled; M12A plug; angled; 4-pole; Length: 2 m

www.wago.com/756-5510/040-020



Item no.: 756-5401/040-020

Sensor/Actuator cable; M12A socket; straight; M12A plug; straight; 4-pole; Length: 2 m

www.wago.com/756-5401/040-020

Subject to changes. Please also observe the further product documentation!

WAGO Kontakttechnik GmbH & Co. KG

Hansastr. 27













32423 Minden

Phone: +49571 887-0 | Fax: +49571 887-169

Email: info.de@wago.com | Web: www.wago.com

Do you have any questions about our products?

We are always happy to take your call at +49 (571) 887-44222.

| | | |
|--|---|--|
|  | Item no.: 756-5401/040-010 Sensor/Actuator cable; M12A socket; straight; M12A plug; straight; 4-pole; Length: 1 m | www.wago.com/756-5401/040-010 |
|  | Item no.: 756-5507/040-010 Sensor/Actuator cable; M8 socket; straight; M12A plug; straight; 4-pole; Length: 1 m | www.wago.com/756-5507/040-010 |
|  | Item no.: 756-5507/040-020 Sensor/Actuator cable; M8 socket; straight; M12A plug; straight; 4-pole; Length: 2 m | www.wago.com/756-5507/040-020 |
|  | Item no.: 756-5404/040-010 Sensor/Actuator cable; M12A socket; angled; M12A plug; angled; 4-pole; Length: 1 m | www.wago.com/756-5404/040-010 |
|  | Item no.: 756-5312/040-015 Sensor/Actuator cable; M12B socket; straight; 4-pole; Length: 1.5 m | www.wago.com/756-5312/040-015 |
|  | Item no.: 756-5312/040-050 Sensor/Actuator cable; M12B socket; straight; 4-pole; Length: 5 m | www.wago.com/756-5312/040-050 |
|  | Item no.: 756-5509/040-010 Sensor/Actuator cable; M8 socket; angled; M12A plug; straight; 4-pole; Length: 1 m | www.wago.com/756-5509/040-010 |
|  | Item no.: 756-5509/040-020 Sensor/Actuator cable; M8 socket; angled; M12A plug; straight; 4-pole; Length: 2 m | www.wago.com/756-5509/040-020 |
|  | Item no.: 756-5403/040-010 Sensor/Actuator cable; M12A socket; angled; M12A plug; straight; 4-pole; Length: 1 m | www.wago.com/756-5403/040-010 |
|  | Item no.: 756-5312/040-100 Sensor/Actuator cable; M12B socket; straight; 4-pole; Length: 10 m | www.wago.com/756-5312/040-100 |
|  | Item no.: 756-5403/040-020 Sensor/Actuator cable; M12A socket; angled; M12A plug; straight; 4-pole; Length: 2 m | www.wago.com/756-5403/040-020 |
|  | Item no.: 756-5508/040-010 Sensor/Actuator cable; M8 socket; straight; M12A plug; angled; 4-pole; Length: 1 m | www.wago.com/756-5508/040-010 |
|  | Item no.: 756-5508/040-020 Sensor/Actuator cable; M8 socket; straight; M12A plug; angled; 4-pole; Length: 2 m | www.wago.com/756-5508/040-020 |

Configurable connectors

Subject to changes. Please also observe the further product documentation!



Item no.: 756-9202/040-000
Fitted pluggable connector; 4-pole; M12 plug, straight, A-coded; Spring

www.wago.com/756-9202/040-000



Item no.: 756-9205/040-000
Fitted pluggable connector; 4-pole; M12 plug, right angle; Spring

www.wago.com/756-9205/040-000



Item no.: 756-9711/050-000
Fitted pluggable connector; 5-pole, shielded; M12 socket, straight; IDC technology

www.wago.com/756-9711/050-000



Item no.: 756-9701/050-000
Fitted pluggable connector; 5-pole, shielded; M12 plug, straight; IDC technology

www.wago.com/756-9701/050-000

Configurable shielded connectors



Item no.: 756-9501/060-000
Fitted pluggable connector; 5-pole, shielded; M12 plug, straight, D-coded; Spring

www.wago.com/756-9501/060-000



Item no.: 756-9501/040-000
Accessories; M12 plug, right angle; 4-pole

www.wago.com/756-9501/040-000

Power cable



Item no.: 756-3501/050-075
Power cable; M12L socket; straight; 5-pole; Length: 7.5 m

www.wago.com/756-3501/050-075



Item no.: 756-3501/050-100
Power cable; M12L socket; straight; 5-pole; Length: 10 m

www.wago.com/756-3501/050-100



Item no.: 756-3501/050-150
Power cable; M12L socket; straight; 5-pole; Length: 15 m

www.wago.com/756-3501/050-150



Item no.: 756-3501/050-050
Power cable; M12L socket; straight; 5-pole; Length: 5 m













www.wago.com/756-3501/050-050















Item no.: 756-3502/050-050
Power cable; M12L socket; angled; 5-pole; Length: 5 m

www.wago.com/756-3502/050-050













Subject to changes. Please also observe the further product documentation!

| | | |
|--|---|--|
|  | Item no.: 756-3502/050-150 Power cable; M12L socket; angled; 5-pole; Length: 15 m | www.wago.com/756-3502/050-150 |
|  | Item no.: 756-3502/050-075 Power cable; M12L socket; angled; 5-pole; Length: 7.5 m | www.wago.com/756-3502/050-075 |
|  | Item no.: 756-3502/050-100 Power cable; M12L socket; angled; 5-pole; Length: 10 m | www.wago.com/756-3502/050-100 |
|  | Item no.: 756-3503/050-075 Power cable; M12L plug; straight; 5-pole; Length: 7.5 m | www.wago.com/756-3503/050-075 |
|  | Item no.: 756-3503/050-150 Power cable; M12L plug; straight; 5-pole; Length: 15 m | www.wago.com/756-3503/050-150 |
|  | Item no.: 756-3503/050-100 Power cable; M12L plug; straight; 5-pole; Length: 10 m | www.wago.com/756-3503/050-100 |
|  | Item no.: 756-3505/050-003 Power cable; M12L socket; straight; M12L plug; straight; 5-pole; Length: 0.3 m | www.wago.com/756-3505/050-003 |
|  | Item no.: 756-3505/050-005 Power cable; M12L socket; straight; M12L plug; straight; 5-pole; Length: 0.5 m | www.wago.com/756-3505/050-005 |
|  | Item no.: 756-3505/050-020 Power cable; M12L socket; straight; M12L plug; straight; 5-pole; Length: 2 m | www.wago.com/756-3505/050-020 |
|  | Item no.: 756-3505/050-010 Power cable; M12L socket; straight; M12L plug; straight; 5-pole; Length: 1 m | www.wago.com/756-3505/050-010 |
|  | Item no.: 756-3505/050-050 Power cable; M12L socket; straight; M12L plug; straight; 5-pole; Length: 5 m | www.wago.com/756-3505/050-050 |
|  | Item no.: 756-3505/050-075 Power cable; M12L socket; straight; M12L plug; straight; 5-pole; Length: 7.5 m | www.wago.com/756-3505/050-075 |

Subject to changes. Please also observe the further product documentation!

| | | |
|--|--|--|
|  | Item no.: 756-3505/050-100 Power cable; M12L socket; straight; M12L plug; straight; 5-pole; Length: 10 m | www.wago.com/756-3505/050-100 |
|  | Item no.: 756-3506/050-100 Power cable; M12L socket; angled; M12L plug; angled; 5-pole; Length: 10 m | www.wago.com/756-3506/050-100 |
|  | Item no.: 756-3506/050-075 Power cable; M12L socket; angled; M12L plug; angled; 5-pole; Length: 7.5 m | www.wago.com/756-3506/050-075 |
|  | Item no.: 756-3506/050-150 Power cable; M12L socket; angled; M12L plug; angled; 5-pole; Length: 15 m | www.wago.com/756-3506/050-150 |
|  | Item no.: 756-3501/050-020 Power cable; M12L socket; straight; 5-pole; Length: 2 m | www.wago.com/756-3501/050-020 |
|  | Item no.: 756-3502/050-020 Power cable; M12L socket; angled; 5-pole; Length: 2 m | www.wago.com/756-3502/050-020 |
|  | Item no.: 756-3503/050-020 Power cable; M12L plug; straight; 5-pole; Length: 2 m | www.wago.com/756-3503/050-020 |
|  | Item no.: 756-3503/050-050 Power cable; M12L plug; straight; 5-pole; Length: 5 m | www.wago.com/756-3503/050-050 |
|  | Item no.: 756-3504/050-020 Power cable; M12L plug; angled; 5-pole; Length: 2 m | www.wago.com/756-3504/050-020 |
|  | Item no.: 756-3504/050-050 Power cable; M12L plug; angled; 5-pole; Length: 5 m | www.wago.com/756-3504/050-050 |
|  | Item no.: 756-3504/050-075 Power cable; M12L plug; angled; 5-pole; Length: 7.5 m | www.wago.com/756-3504/050-075 |
|  | Item no.: 756-3504/050-100 Power cable; M12L plug; angled; 5-pole; Length: 10 m | www.wago.com/756-3504/050-100 |

Subject to changes. Please also observe the further product documentation!

| | | |
|--|--|--|
|  | Item no.: 756-3504/050-150 Power cable; M12L plug; angled; 5-pole; Length: 15 m | www.wago.com/756-3504/050-150 |
|  | Item no.: 756-3505/050-150 Power cable; M12L socket; straight; M12L plug; straight; 5-pole; Length: 15 m | www.wago.com/756-3505/050-150 |
|  | Item no.: 756-3506/050-003 Power cable; M12L socket; angled; M12L plug; angled; 5-pole; Length: 0.3 m | www.wago.com/756-3506/050-003 |
|  | Item no.: 756-3506/050-005 Power cable; M12L socket; angled; M12L plug; angled; 5-pole; Length: 0.5 m | www.wago.com/756-3506/050-005 |
|  | Item no.: 756-3506/050-020 Power cable; M12L socket; angled; M12L plug; angled; 5-pole; Length: 2 m | www.wago.com/756-3506/050-020 |
|  | Item no.: 756-3506/050-010 Power cable; M12L socket; angled; M12L plug; angled; 5-pole; Length: 1 m | www.wago.com/756-3506/050-010 |
|  | Item no.: 756-3506/050-050 Power cable; M12L socket; angled; M12L plug; angled; 5-pole; Length: 5 m | www.wago.com/756-3506/050-050 |
| Distribution connector | | |
|  | Item no.: 756-5513/040-010 Sensor/Actuator cable; 2xM8 socket; straight; M12A plug; straight; 4-pole; Length: 1 m | www.wago.com/756-5513/040-010 |
|  | Item no.: 756-5513/040-020 Sensor/Actuator cable; 2xM8 socket; straight; M12A plug; straight; 4-pole; Length: 2 m | www.wago.com/756-5513/040-020 |
|  | Item no.: 756-5514/040-010 Sensor/Actuator cable; 2xM8 socket; angled; M12A plug; straight; 4-pole; Length: 1 m | www.wago.com/756-5514/040-010 |
|  | Item no.: 756-5514/040-020 Sensor/Actuator cable; 2xM8 socket; angled; M12A plug; straight; 4-pole; Length: 2 m | www.wago.com/756-5514/040-020 |
|  | Item no.: 756-5516/040-010 Sensor/Actuator cable; 2xM12 socket; straight; M12A plug; straight; 4-pole; Length: 1 m | www.wago.com/756-5516/040-010 |
|  | Item no.: 756-5516/040-020 Sensor/Actuator cable; 2xM12 socket; straight; M12A plug; straight; 4-pole; Length: 2 m | www.wago.com/756-5516/040-020 |

Subject to changes. Please also observe the further product documentation!



Item no.: 756-5517/040-010

Sensor/Actuator cable; 2xM12 socket; angled; M12A plug; straight; 4-pole; Length: 1 m

www.wago.com/756-5517/040-010



Item no.: 756-5517/040-020

Sensor/Actuator cable; 2xM12 socket; angled; M12A plug; straight; 4-pole; Length: 2 m

www.wago.com/756-5517/040-020



Item no.: 756-9301/050-000

Accessories; 5-pole

www.wago.com/756-9301/050-000



Item no.: 756-9301/040-000

Accessories; 4-pole

www.wago.com/756-9301/040-000

ETHERNET/PROFINET cable



Item no.: 756-1202/060-200

ETHERNET cable; M12D plug; angled; 4-pole; Length: 20 m

www.wago.com/756-1202/060-200



Item no.: 756-1201/060-100

ETHERNET cable; M12D plug; straight; 4-pole; Length: 10 m

www.wago.com/756-1201/060-100



Item no.: 756-1201/060-050

ETHERNET cable; M12D plug; straight; 4-pole; Length: 5 m

www.wago.com/756-1201/060-050



Item no.: 756-1203/060-050

ETHERNET cable; M12D plug; straight; M12D plug; straight; 4-pole; Length: 5 m

www.wago.com/756-1203/060-050



Item no.: 756-1203/060-020

ETHERNET cable; M12D plug; straight; M12D plug; straight; 4-pole; Length: 2 m

www.wago.com/756-1203/060-020



Item no.: 756-1202/060-020

ETHERNET cable; M12D plug; angled; 4-pole; Length: 2 m

www.wago.com/756-1202/060-020



Item no.: 756-1201/060-200

ETHERNET cable; M12D plug; straight; 4-pole; Length: 20 m

www.wago.com/756-1201/060-200

Subject to changes. Please also observe the further product documentation!

WAGO Kontakttechnik GmbH & Co. KG

Hansastr. 27

32423 Minden

Phone: +49571 887-0 | Fax: +49571 887-169

Email: info.de@wago.com | Web: www.wago.com

Do you have any questions about our products?

We are always happy to take your call at +49 (571) 887-44222.



Item no.: 756-1204/060-050
ETHERNET cable; M12D plug; angled; M12D plug; angled; 4-pole; Length: 5 m

www.wago.com/756-1204/060-050



Item no.: 756-1204/060-100
ETHERNET cable; M12D plug; angled; M12D plug; angled; 4-pole; Length: 10 m

www.wago.com/756-1204/060-100



Item no.: 756-1204/060-200
ETHERNET cable; M12D plug; angled; M12D plug; angled; 4-pole; Length: 20 m

www.wago.com/756-1204/060-200



Item no.: 756-1203/060-200
ETHERNET cable; M12D plug; straight; M12D plug; straight; 4-pole; Length: 20 m

www.wago.com/756-1203/060-200



Item no.: 756-1203/060-100
ETHERNET cable; M12D plug; straight; M12D plug; straight; 4-pole; Length: 10 m

www.wago.com/756-1203/060-100



Item no.: 756-1204/060-010
ETHERNET cable; M12D plug; angled; M12D plug; angled; 4-pole; Length: 0.1 m

www.wago.com/756-1204/060-010



Item no.: 756-1204/060-030
ETHERNET cable; M12D plug; angled; M12D plug; angled; 4-pole; Length: 3 m

www.wago.com/756-1204/060-030



Item no.: 756-1204/060-020
ETHERNET cable; M12D plug; angled; M12D plug; angled; 4-pole; Length: 2 m

www.wago.com/756-1204/060-020



Item no.: 756-1202/060-050
ETHERNET cable; M12D plug; angled; 4-pole; Length: 5 m

www.wago.com/756-1202/060-050



Item no.: 756-1202/060-100
ETHERNET cable; M12D plug; angled; 4-pole; Length: 10 m

www.wago.com/756-1202/060-100



Item no.: 756-1201/060-020
ETHERNET cable; M12D plug; straight; 4-pole; Length: 2 m

www.wago.com/756-1201/060-020

Downloads

Documentation

Manual

Subject to changes. Please also observe the further product documentation!



| | | | |
|--|------------------------|---------------|----------|
| 8-Port-IO Link Master Class A; EtherCAT; 24 VDC / 2.0 A; 8xM12 Connection; WideLine | V 1.0.0 2021. 6. 8. | pdf 6.6 MB | Download |
|--|------------------------|---------------|----------|

System Description

| | | | |
|--|--|-----------------|----------|
| WAGO I/O System Field; General Product Information | | pdf 708.2 kB | Download |
|--|--|-----------------|----------|

Engineering-Software

WAGO IO-Link Configurator

| | | | |
|---------------------------|-----------------------------|-----------------|----------|
| WAGO IO-Link Configurator | V5.1.1-6015 2021. 8. 24. | ZIP 159.6 MB | Download |
|---------------------------|-----------------------------|-----------------|----------|

WAGO IO-Link Configurator allows configuration, parameterization, operation and monitoring of WAGO IO-Link Masters in the WAGO I/O System 750 and WAGO I/O System Field, and especially of the WAGO IO-Link devices connected to them.

Additionally, WAGO IO-Link Configurator can be used for complete configuration and operation of all IO-Link devices of third-party manufacturers, as long as they comply with the IO-Link specification. A product's process data can be visualized graphically and stored in trend curves. Up to eight elements can be selected for visualization, and the data can be recorded for up to 24 hours.

Device description files for the IO-Link Masters (IOLM) or IO-Link Devices (IODD) can be used to integrate new devices into the tool at any time. Convenient access to the IO-Link user organization's IODDfinder is available for the IODDs. This allows automated, selective download of IODDs when integrating new IO-Link devices. An integrated IODD viewer allows detailed insight into the IODD device description.

WAGO IO-Link Configurator can be used either as a standalone program or integrated into engineering systems with a TCI interface and *WAGO-I/O-CHECK*.

IO-Link Configurator can also be used to integrate the IO-Link Master (750-657) of the WAGO I/O System 750 Series and to access all the configurator's functions. This is made possible by the WAGO I/O System 750 IO-Link Adapter, which can be retrofitted. The WAGO I/O System 750 IO-Link Adapter requires the current version of WAGO IO-Link Configurator and a current version of WAGO-I/O-CHECK.

In addition, the download file contains the device descriptions for the respective fieldbus systems of the WAGO I/O System Field modules. These are pre-installed in the Configurator setup.

The WAGO IO-Link Configurator license is assigned to the specific PC on which it is installed (a workstation license).

Register now and test our engineering software for 30 days at no cost.

Device Files

Device Description File

| | | | |
|---|-------------------|-----------------|----------|
| (750-909) ESI file for EtherCAT 750 Series and 765 Series | 23 2021. 7. 9. | zip 216.9 kB | Download |
| Gerätebeschreibungsdateien 765-42xx, 765-12xx, EtherCAT | V1_1_0_17 | zip 72 B | Download |

Subject to changes. Please also observe the further product documentation!



Environmental Product Compliance

Compliance Search

| Environmental Product Compliance 765-4201/100-000 | URL | Download |
|--|-----|----------|
| 8-Port-IO Link Master Class A; EtherCAT; DC 24 V / 2.0 A; 8xM12 connection; WideLine | | |

Installation Notes

Product family

I/O System Field

[Show all products from the family](#)

Subject to changes. Please also observe the further product documentation!