

MHCC、MHCI Series



MHCC series is designed for low profile type with low RDC and ultra large current. Its molded magnetic shielded type is suitable for high-density mounting and ultra low buzz noise. Soldering conditions can be easily confirmed when mounting onto the board. This series also provides customers with embossed carrier type packaging for automatic mounting machine.

Features

- RoHS, Halogen Free and REACH Compliance
- High rated current
- Ultra low buzz noise

Applications

- Laptops and PCs
- Switches and servers
- Base stations
- DC/DC converters

Product Identification



Shape and Dimensions

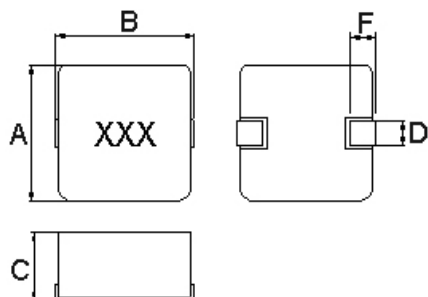

Dimensions in mm

| TYPE | A | B Max | C Max | D | F |
|-------|----------|---------|---------|---------|---------|
| 04012 | 4.1±0.2 | 4.6±0.2 | 1.2 | 1.5±0.3 | 1.0±0.5 |
| 04015 | 4.1±0.2 | 4.6±0.2 | 1.5 | 1.5±0.3 | 1.0±0.5 |
| 04020 | 4.1±0.2 | 4.6±0.2 | 2.0 | 1.5±0.3 | 1.0±0.5 |
| 05012 | 5.4±0.35 | 5.7±0.2 | 1.2 | 2.0±0.3 | 1.5±0.3 |
| 05015 | 5.4±0.35 | 5.7±0.2 | 1.5 | 2.0±0.3 | 1.5±0.3 |
| 05018 | 5.4±0.35 | 5.7±0.2 | 1.8 | 2.0±0.3 | 1.5±0.3 |
| 05020 | 5.4±0.35 | 5.7±0.2 | 1.8±0.2 | 2.0±0.3 | 1.5±0.3 |
| 05030 | 5.4±0.35 | 5.7±0.2 | 3.0 | 2.0±0.3 | 1.5±0.3 |
| 06012 | 6.6±0.2 | 7.3 | 1.2 | 2.9 | 1.6±0.5 |
| 06015 | 6.6±0.2 | 7.3 | 1.3±0.2 | 2.9 | 1.6±0.5 |
| 06018 | 6.6±0.2 | 7.3 | 1.6±0.2 | 2.9 | 1.6±0.5 |
| 06024 | 6.6±0.2 | 7.3 | 2.4 | 2.9 | 1.6±0.5 |
| 06030 | 6.6±0.2 | 7.3 | 3.0 | 2.9 | 1.6±0.5 |
| 06050 | 6.6±0.2 | 7.3 | 5.0 | 2.9 | 1.6±0.5 |
| 10030 | 10.1±0.3 | 11.6 | 3.0 | 3.0 | 2.5±0.5 |
| 10040 | 10.1±0.3 | 11.6 | 4.0 | 3.0 | 2.5±0.5 |
| 12050 | 12.6±0.2 | 13.8 | 5.0 | 3.7 | 2.7±0.7 |
| 12060 | 12.6±0.2 | 13.8 | 6.0 | 3.7 | 2.7±0.7 |

Recommended Pattern

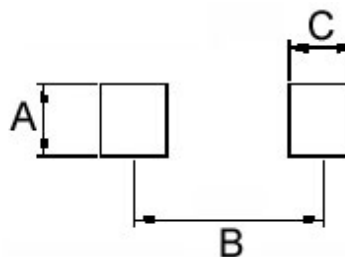

Dimensions in mm

| TYPE | A | B | C |
|-------|-----|------|------|
| 04012 | 2.5 | 3.7 | 1.5 |
| 04015 | 2.5 | 3.7 | 1.5 |
| 04020 | 2.5 | 3.7 | 1.5 |
| 05012 | 2.5 | 4.1 | 1.9 |
| 05015 | 2.5 | 4.1 | 1.9 |
| 05018 | 2.5 | 4.1 | 1.9 |
| 05020 | 2.5 | 4.1 | 1.9 |
| 05030 | 2.5 | 4.1 | 1.9 |
| 06012 | 3.5 | 6.05 | 2.35 |
| 06015 | 3.5 | 6.05 | 2.35 |
| 06018 | 3.5 | 6.05 | 2.35 |
| 06024 | 3.5 | 6.05 | 2.35 |
| 06030 | 3.5 | 6.05 | 2.35 |
| 06050 | 3.5 | 6.05 | 2.35 |
| 10030 | 4.0 | 9.5 | 3.5 |
| 10040 | 4.0 | 9.5 | 3.5 |
| 12050 | 5.0 | 10.5 | 4.0 |
| 12060 | 5.0 | 10.5 | 4.0 |

Electrical Characteristics

| Part Number | Inductance (uH) | Tolerance (±%) | Test Frequency (kHz) | RDC (mΩ) Max | Isat (A)Typ. | Irms (A)Typ. |
|-------------------|-----------------|----------------|----------------------|--------------|--------------|--------------|
| MHCI04012-R22M-R8 | 0.22 | 20 | 100 | 12 | 11.5 | 8.5 |
| MHCI04012-R33M-R8 | 0.33 | 20 | 100 | 19 | 8.5 | 6.5 |
| MHCI04012-R47M-R8 | 0.47 | 20 | 100 | 25 | 7.0 | 5.0 |
| MHCI04012-R68M-R8 | 0.68 | 20 | 100 | 36 | 6.0 | 4.5 |
| MHCI04012-1R0M-R8 | 1.0 | 20 | 100 | 47 | 5.2 | 4.2 |
| MHCI04012-1R5M-R8 | 1.5 | 20 | 100 | 75 | 4.0 | 3.25 |
| MHCI04012-2R2M-R8 | 2.2 | 20 | 100 | 83.5 | 3.5 | 2.75 |
| MHCI04012-3R3M-R8 | 3.3 | 20 | 100 | 165 | 3.0 | 2.0 |
| MHCI04012-4R7M-R8 | 4.7 | 20 | 100 | 195 | 2.8 | 1.8 |

Note: When ordering, please specify tolerance code. Tolerance: M=±20%

- Operating temperature range - 55°C ~ 125°C(Including self - temperature rise)
- Isat for Inductance drop 30% from its value with current
- I rms for a 40°C temperature rise from 25°C ambient with current
- Measure Equipment :
 L : WK 3260B or WK 6500P, 100kHz 0.5V
 RDC : CHEN HWA 502 or CHEN HWA 46502B

Test Instruments : WK3260B Impedance / Material Analyzer

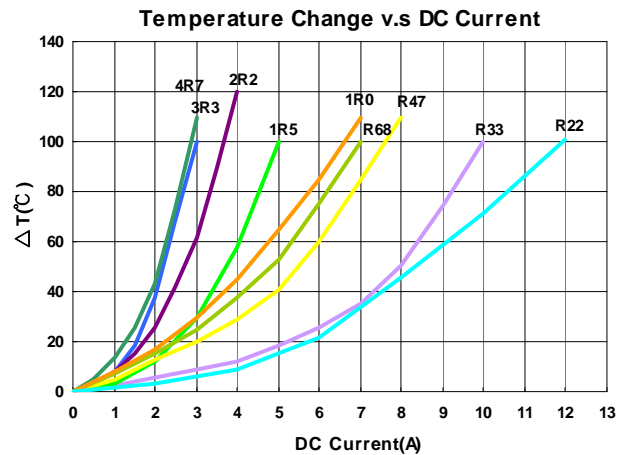
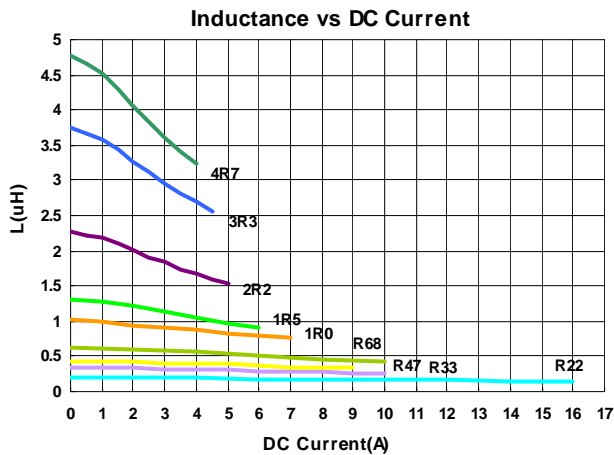

Molding Power Choke – MHCC/MHCI Series

Electrical Characteristics

| Part Number | Inductance (uH) | Tolerance (±%) | Test Frequency (kHz) | RDC (mΩ) Max | Isat (A)Typ. | Irms (A)Typ. |
|-------------------|-----------------|----------------|----------------------|--------------|--------------|--------------|
| MHCI04015-1R0M-R8 | 1.0 | 20 | 100 | 42 | 7 | 4 |
| MHCI04015-1R5M-R8 | 1.5 | 20 | 100 | 50 | 6 | 3.5 |
| MHCI04015-2R2M-R8 | 2.2 | 20 | 100 | 79 | 5 | 3 |
| MHCI04015-3R3M-R8 | 3.3 | 20 | 100 | 132 | 4.5 | 2.3 |
| MHCI04015-4R7M-R8 | 4.7 | 20 | 100 | 146 | 4 | 2 |

Note: When ordering, please specify tolerance code. Tolerance: M=±20%

- Operating temperature range - 55°C ~ 125°C(Including self - temperature rise)
- Isat for Inductance drop 30% from its value with current
- I rms for a 40°C temperature rise from 25°C ambient with current
- Measure Equipment :
L : WK 3260B or WK 6500P, 100kHz 0.5V
RDC : CHEN HWA 502 or CHEN HWA 46502B

Test Instruments : WK3260B Impedance / Material Analyzer

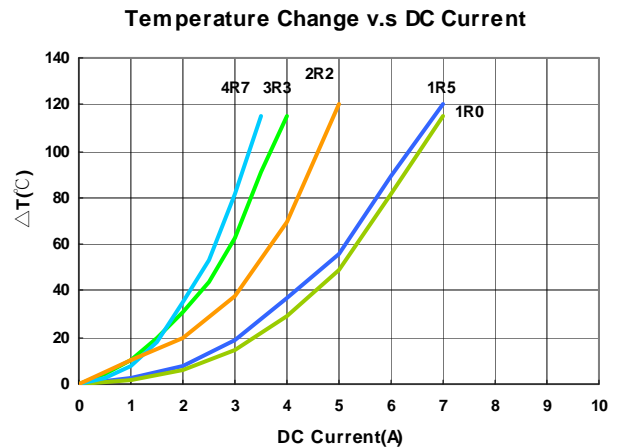
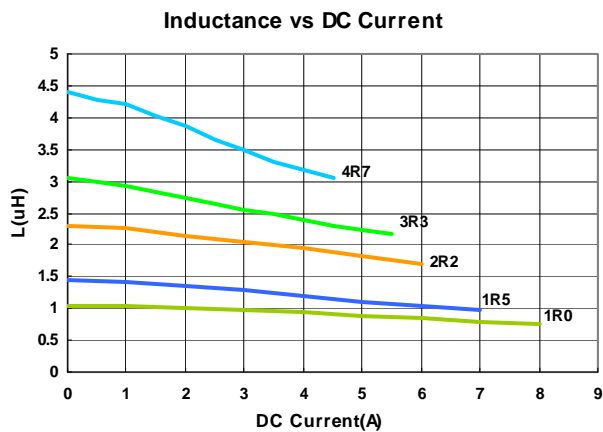

Electrical Characteristics

| Part Number | Inductance (uH) | Tolerance (±%) | Test Frequency (kHz) | RDC (mΩ) Max | Isat (A)Typ. | Irms (A)Typ. |
|-------------------|-----------------|----------------|----------------------|--------------|--------------|--------------|
| MHCI04020-R10M-R8 | 0.10 | 20 | 100 | 4 | 25 | 12.0 |
| MHCI04020-R22M-R8 | 0.22 | 20 | 100 | 6.6 | 12.5 | 9.0 |
| MHCI04020-R47M-R8 | 0.47 | 20 | 100 | 14 | 9.5 | 7.0 |
| MHCI04020-R56M-R8 | 0.56 | 20 | 100 | 16 | 10.0 | 6.5 |
| MHCI04020-R68M-R8 | 0.68 | 20 | 100 | 21 | 8.0 | 5.2 |
| MHCI04020-1R0M-R8 | 1.0 | 20 | 100 | 27 | 7.0 | 4.5 |
| MHCI04020-1R5M-R8 | 1.5 | 20 | 100 | 46 | 6.0 | 4.0 |
| MHCI04020-2R2M-R8 | 2.2 | 20 | 100 | 58 | 5.0 | 3.0 |
| MHCI04020-3R3M-R8 | 3.3 | 20 | 100 | 87 | 4.0 | 2.5 |
| MHCI04020-4R7M-R8 | 4.7 | 20 | 100 | 105 | 3.0 | 2.2 |
| MHCI04020-6R8M-R8 | 6.8 | 20 | 100 | 135 | 2.5 | 2.0 |
| MHCI04020-8R2M-R8 | 8.2 | 20 | 100 | 216 | 2.5 | 2.0 |
| MHCI04020-100M-R8 | 10 | 20 | 100 | 258 | 2.0 | 1.6 |

Note: When ordering, please specify tolerance code. Tolerance: M=±20%

- Operating temperature range - 55°C ~ 125°C(Including self - temperature rise)
- Isat for Inductance drop 30% from its value with current
- I rms for a 40°C temperature rise from 25°C ambient with current
- Measure Equipment :
 L : WK 3260B or WK 6500P, 100KHz 0.5V
 RDC : CHEN HWA 502 or CHEN HWA 46502B

Test Instruments : WK3260B Impedance / Material Analyzer

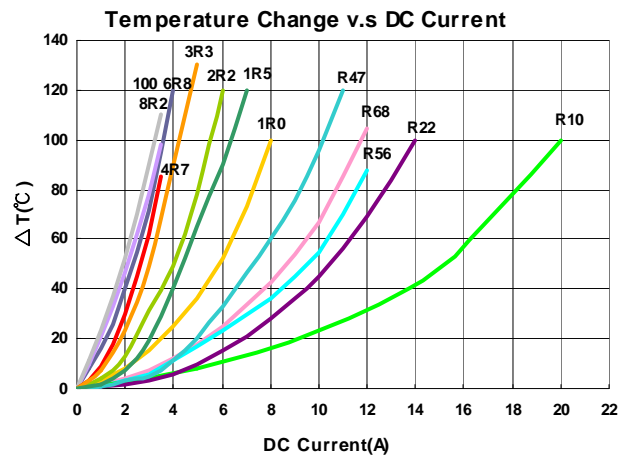
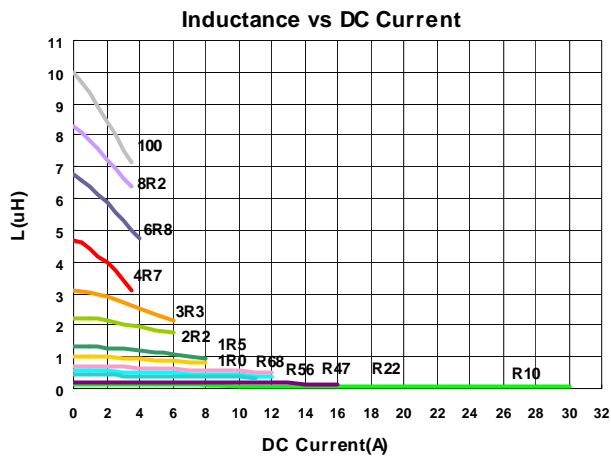

Electrical Characteristics

| Part Number | Inductance (uH) | Tolerance (±%) | Test Frequency (kHz) | RDC (mΩ) Max | Isat (A)Typ. | Irms (A)Typ. |
|--------------------|-----------------|----------------|----------------------|--------------|--------------|--------------|
| MHCI05012-2R2M-R8A | 2.2 | 20 | 100 | 76 | 4 | 3.5 |
| MHCI05012-6R8M-R8A | 6.8 | 20 | 100 | 250 | 2.3 | 2.0 |

Note: When ordering, please specify tolerance code. Tolerance: M=±20%

- Operating temperature range - 55°C ~ 125°C(Including self - temperature rise)
- Isat for Inductance drop 30% from its value with current
- I rms for a 40°C temperature rise from 25°C ambient with current
- Measure Equipment :
 L : WK 3260B or WK 6500P, 100kHz 0.5V
 RDC : CHEN HWA 502 or CHEN HWA 46502B

Test Instruments : WK3260B Impedance / Material Analyzer

Inductance vs DC Current

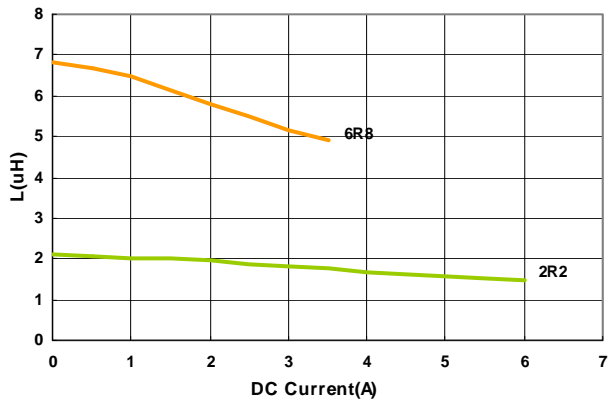

Temperature Change v.s DC Current

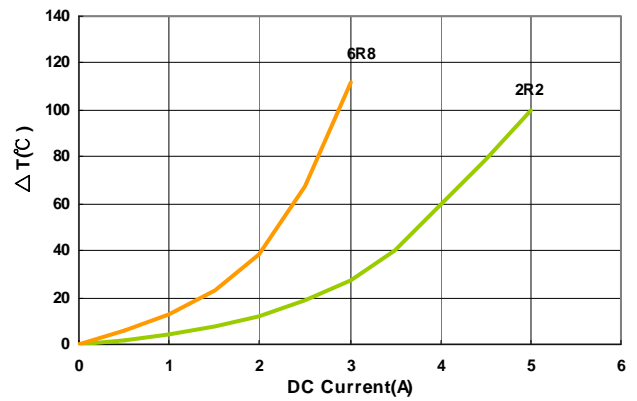

Electrical Characteristics

| Part Number | Inductance (uH) | Tolerance (±%) | Test Frequency (kHz) | RDC (mΩ) Max | Isat (A)Typ. | Irms (A)Typ. |
|-------------------|-----------------|----------------|----------------------|--------------|--------------|--------------|
| MHCI05015-R47M-R8 | 0.47 | 20 | 100 | 16 | 12 | 8.0 |
| MHCI05015-R68M-R8 | 0.68 | 20 | 100 | 23 | 10 | 6.0 |
| MHCI05015-1R0M-R8 | 1.0 | 20 | 100 | 33 | 8.0 | 5.0 |
| MHCI05015-1R5M-R8 | 1.5 | 20 | 100 | 50 | 6.0 | 4.0 |
| MHCI05015-2R2M-R8 | 2.2 | 20 | 100 | 68 | 6.0 | 3.3 |
| MHCI05015-3R3M-R8 | 3.3 | 20 | 100 | 84 | 5.0 | 3.0 |
| MHCI05015-4R7M-R8 | 4.7 | 20 | 100 | 135 | 4.0 | 2.5 |
| MHCI05015-5R6M-R8 | 5.6 | 20 | 100 | 175 | 3.5 | 2.2 |
| MHCI05015-6R8M-R8 | 6.8 | 20 | 100 | 192 | 3.0 | 2.0 |
| MHCI05015-100M-R8 | 10 | 20 | 100 | 195 | 2.0 | 1.5 |

Note: When ordering, please specify tolerance code. Tolerance: M=±20%

- Operating temperature range - 55°C ~ 125°C(Including self - temperature rise)
- Isat for Inductance drop 30% from its value with current
- I rms for a 40°C temperature rise from 25°C ambient with current
- Measure Equipment :
 L : WK 3260B or WK 6500P, 100kHz 0.5V
 RDC : CHEN HWA 502 or CHEN HWA 46502B

Test Instruments : WK3260B Impedance / Material Analyzer

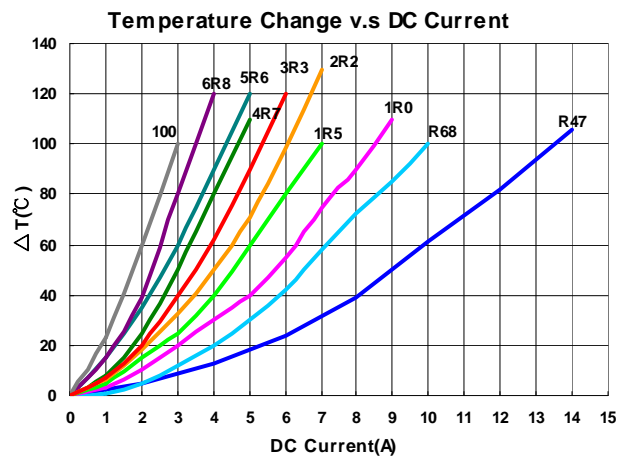
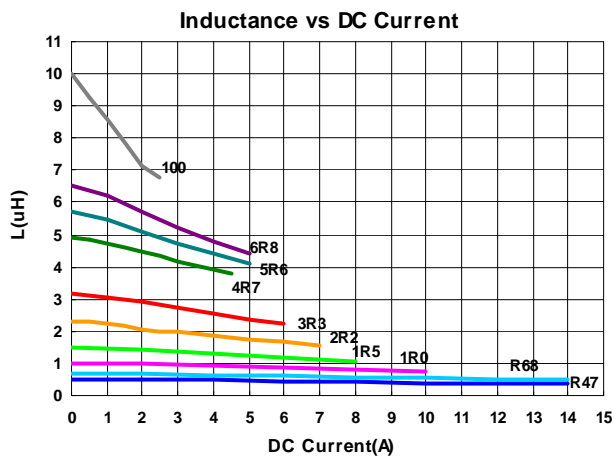

Electrical Characteristics

| Part Number | Inductance (uH) | Tolerance (±%) | Test Frequency (kHz) | RDC (mΩ) Max | Isat (A)Typ. | Irms (A)Typ. |
|--------------------|-----------------|----------------|----------------------|--------------|--------------|--------------|
| MHCI05015-1R0M-R8A | 1.0 | 20 | 100 | 23 | 9 | 6.5 |
| MHCI05015-2R2M-R8A | 2.2 | 20 | 100 | 64 | 6 | 3.3 |
| MHCI05015-4R7M-R8A | 4.7 | 20 | 100 | 106 | 4 | 3.0 |
| MHCI05015-100M-R8A | 10 | 20 | 100 | 170 | 3 | 2.0 |

Note: When ordering, please specify tolerance code. Tolerance: M=±20%

- Operating temperature range - 55°C ~ 125°C(Including self - temperature rise)
- Isat for Inductance drop 30% from its value with current
- I rms for a 40°C temperature rise from 25°C ambient with current
- Measure Equipment :
 L : WK 3260B or WK 6500P, 100kHz 0.5V
 RDC : CHEN HWA 502 or CHEN HWA 46502B

Test Instruments : WK3260B Impedance / Material Analyzer

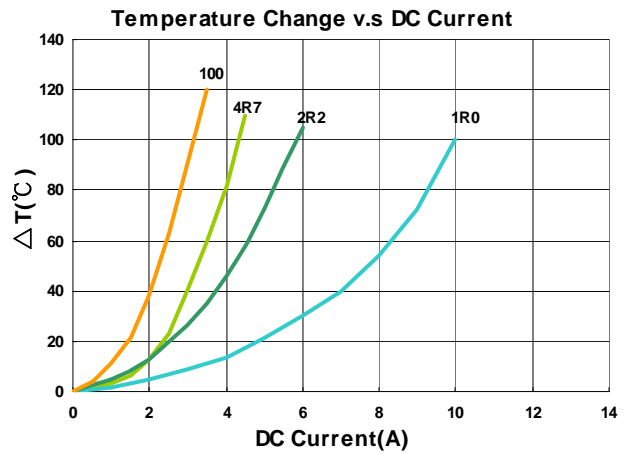
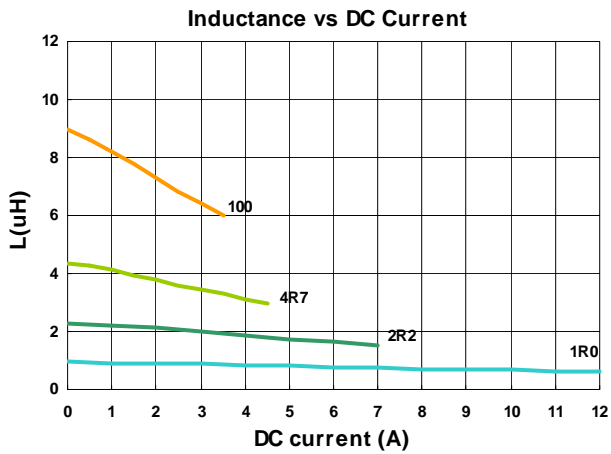

Electrical Characteristics

| Part Number | Inductance (uH) | Tolerance (±%) | Test Frequency (kHz) | RDC (mΩ) Max | Isat (A)Typ. | Irms (A)Typ. |
|--------------------|-----------------|----------------|----------------------|--------------|--------------|--------------|
| MHCI05018-R47M-R8A | 0.47 | 20 | 100 | 9.0 | 15.5 | 10.5 |
| MHCI05018-1R0M-R8A | 1.0 | 20 | 100 | 17 | 9.0 | 8.0 |
| MHCI05018-2R2M-R8A | 2.2 | 20 | 100 | 35 | 6.5 | 5.0 |
| MHCI05018-3R3M-R8A | 3.3 | 20 | 100 | 58 | 5.0 | 4.5 |
| MHCI05018-4R7M-R8A | 4.7 | 20 | 100 | 85 | 4.0 | 3.5 |
| MHCI05018-6R8M-R8A | 6.8 | 20 | 100 | 120 | 3.4 | 2.8 |
| MHCI05018-100M-R8A | 10 | 20 | 100 | 155 | 3.0 | 2.5 |

Note: When ordering, please specify tolerance code. Tolerance: M=±20%

- Operating temperature range - 55°C ~ 125°C(Including self - temperature rise)
- Isat for Inductance drop 30% from its value with current
- Irms for a 40°C temperature rise from 25°C ambient with current
- Measure Equipment :
 L : WK 3260B or WK 6500P, 100kHz 0.5V
 RDC : CHEN HWA 502 or CHEN HWA 46502B

Test Instruments : WK3260B Impedance / Material Analyzer

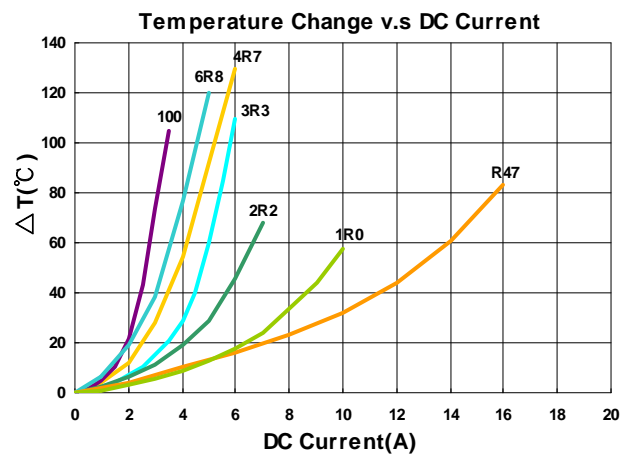
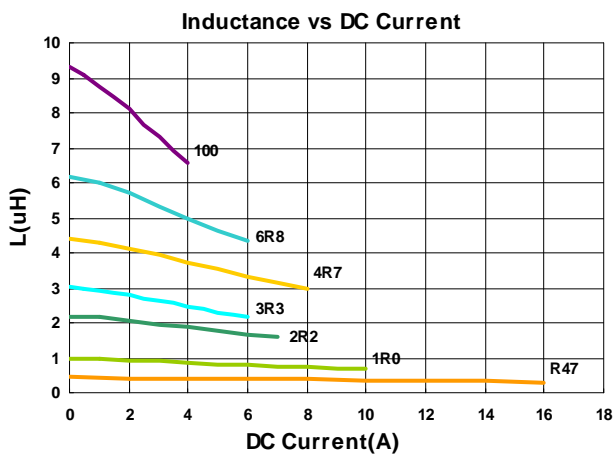

Electrical Characteristics

| Part Number | Inductance (uH) | Tolerance (±%) | Test Frequency (kHz) | RDC (mΩ) Max | Isat (A)Typ. | Irms (A)Typ. |
|-------------------|-----------------|----------------|----------------------|--------------|--------------|--------------|
| MHCI05020-R47M-R8 | 0.47 | 20 | 100 | 9 | 15.5 | 10.5 |
| MHCI05020-1R0M-R8 | 1.0 | 20 | 100 | 30 | 7.0 | 6.0 |
| MHCI05020-1R5M-R8 | 1.5 | 20 | 100 | 35 | 6.5 | 5.5 |
| MHCI05020-2R2M-R8 | 2.2 | 20 | 100 | 45 | 6.0 | 4.0 |
| MHCI05020-3R3M-R8 | 3.3 | 20 | 100 | 60 | 5.5 | 3.5 |
| MHCI05020-4R7M-R8 | 4.7 | 20 | 100 | 90 | 5.0 | 3.0 |
| MHCI05020-5R6M-R8 | 5.6 | 20 | 100 | 120 | 4.5 | 2.8 |
| MHCI05020-6R8M-R8 | 6.8 | 20 | 100 | 125 | 4.5 | 2.8 |
| MHCI05020-100M-R8 | 10 | 20 | 100 | 180 | 4.0 | 2.3 |

Note: When ordering, please specify tolerance code. Tolerance: M=±20%

- Operating temperature range - 55°C ~ 125°C(Including self - temperature rise)
- Isat for Inductance drop 30% from its value with current
- I rms for a 40°C temperature rise from 25°C ambient with current
- Measure Equipment :
 L : WK 3260B or WK 6500P, 100kHz 0.5V
 RDC : CHEN HWA 502 or CHEN HWA 46502B

Test Instruments : WK3260B Impedance / Material Analyzer

Inductance v.s DC Current

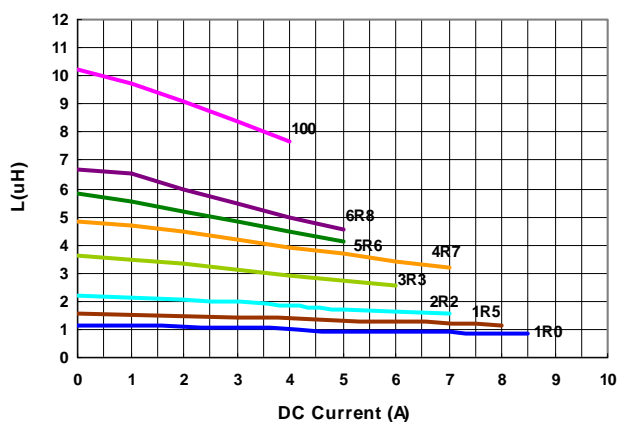

Temperature Change v.s DC Current

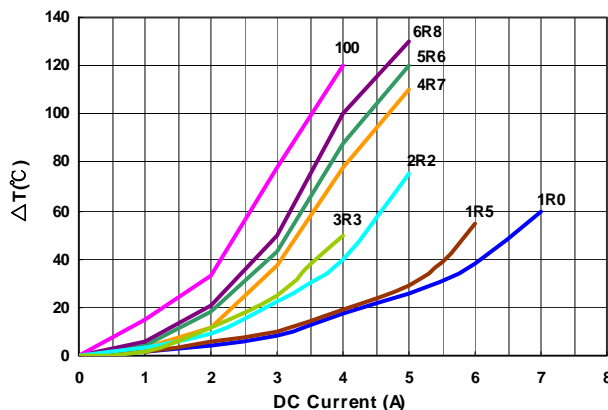

Electrical Characteristics

| Part Number | Inductance (uH) | Tolerance (±%) | Test Frequency (kHz) | RDC (mΩ)Max | Isat (A)Typ. | Irms (A)Typ. |
|-------------------|-----------------|----------------|----------------------|-------------|--------------|--------------|
| MHCI05030-R20M-R8 | 0.20 | 20 | 100 | 3.9 | 14.5 | 17.0 |
| MHCI05030-R47M-R8 | 0.47 | 20 | 100 | 8 | 14 | 10.0 |
| MHCI05030-R68M-R8 | 0.68 | 20 | 100 | 12 | 14 | 8.0 |
| MHCI05030-1R0M-R8 | 1.0 | 20 | 100 | 15 | 11 | 7.0 |
| MHCI05030-1R2M-R8 | 1.2 | 20 | 100 | 15 | 11 | 6.5 |
| MHCI05030-1R5M-R8 | 1.5 | 20 | 100 | 25 | 10 | 6.0 |
| MHCI05030-2R2M-R8 | 2.2 | 20 | 100 | 35 | 8 | 5.0 |
| MHCI05030-3R3M-R8 | 3.3 | 20 | 100 | 46 | 7 | 4.5 |
| MHCI05030-4R7M-R8 | 4.7 | 20 | 100 | 60 | 6 | 4.0 |
| MHCI05030-6R8M-R8 | 6.8 | 20 | 100 | 110 | 5 | 3.0 |
| MHCI05030-100M-R8 | 10 | 20 | 100 | 126 | 4.5 | 1.5 |

Note: When ordering, please specify tolerance code. Tolerance: M=±20%

- Operating temperature range - 55°C ~ 125°C(Including self - temperature rise)
- Isat for Inductance drop 30% from its value with current
- I rms for a 40°C temperature rise from 25°C ambient with current
- Measure Equipment :
 L : WK 3260B or WK 6500P, 100kHz 0.5V
 RDC : CHEN HWA 502 or CHEN HWA 46502B

Test Instruments : WK3260B Impedance / Material Analyzer

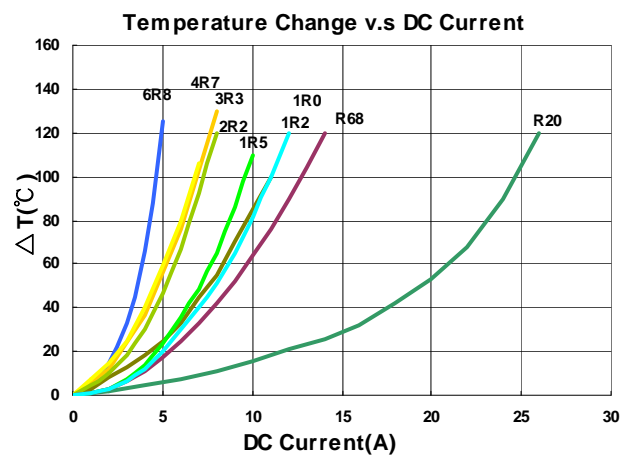
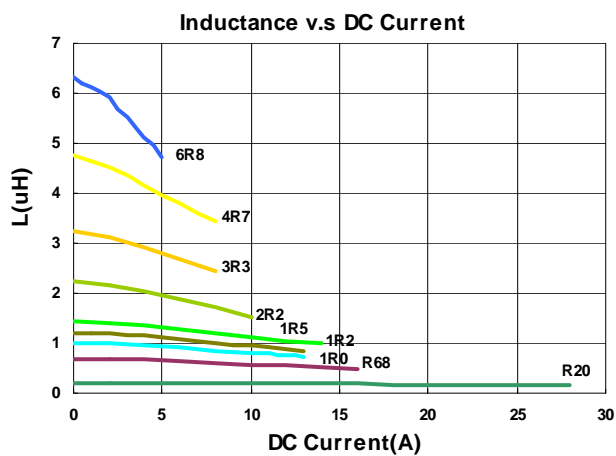

Electrical Characteristics

| Part Number | Inductance (uH) | Tolerance (±%) | Test Frequency (kHz) | RDC (mΩ) Max | Isat (A)Typ. | Irms (A)Typ. |
|-------------------|-----------------|----------------|----------------------|--------------|--------------|--------------|
| MHCI06012-4R7M-R8 | 4.7 | 20 | 100 | 160 | 4.0 | 2.4 |
| MHCI06012-6R8M-R8 | 6.8 | 20 | 100 | 200 | 3.0 | 2.1 |

Note: When ordering, please specify tolerance code. Tolerance: M=±20%

- Operating temperature range - 55°C ~ 125°C(Including self - temperature rise)
- Isat for Inductance drop 30% from its value with current
- I rms for a 40°C temperature rise from 25°C ambient with current
- Measure Equipment :
 L : WK 3260B or WK 6500P, 100kHz 0.5V
 RDC : CHEN HWA 502 or CHEN HWA 46502B

Test Instruments : WK3260B Impedance / Material Analyzer

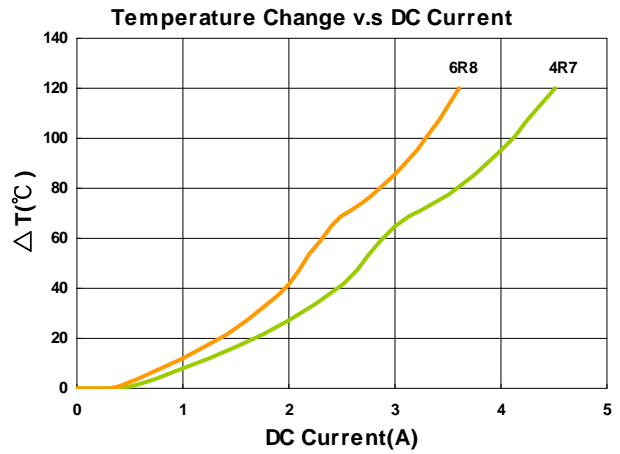
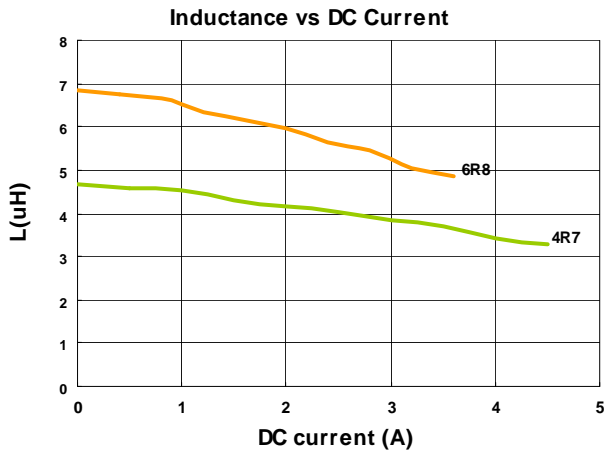

Electrical Characteristics

| Part Number | Inductance (uH) | Tolerance (±%) | Test Frequency (kHz) | RDC (mΩ)Max | Isat (A)Typ. | Irms (A)Typ. |
|-------------------|-----------------|----------------|----------------------|-------------|--------------|--------------|
| MHCI06015-2R2M-R8 | 2.2 | 20 | 100 | 54 | 6.0 | 3.5 |
| MHCI06015-3R3M-R8 | 3.3 | 20 | 100 | 63 | 5.5 | 3.3 |
| MHCI06015-4R7M-R8 | 4.7 | 20 | 100 | 105 | 4.5 | 3.2 |
| MHCI06015-6R8M-R8 | 6.8 | 20 | 100 | 140 | 4.0 | 2.5 |

Note: When ordering, please specify tolerance code. Tolerance: M=±20%

- Operating temperature range - 55°C ~ 125°C(Including self - temperature rise)
- Isat for Inductance drop 30% from its value with current
- I rms for a 40°C temperature rise from 25°C ambient with current
- Measure Equipment :
 L : WK 3260B or WK 6500P, 100kHz 0.5V
 RDC : CHEN HWA 502 or CHEN HWA 46502B

Test Instruments : WK3260B Impedance / Material Analyzer

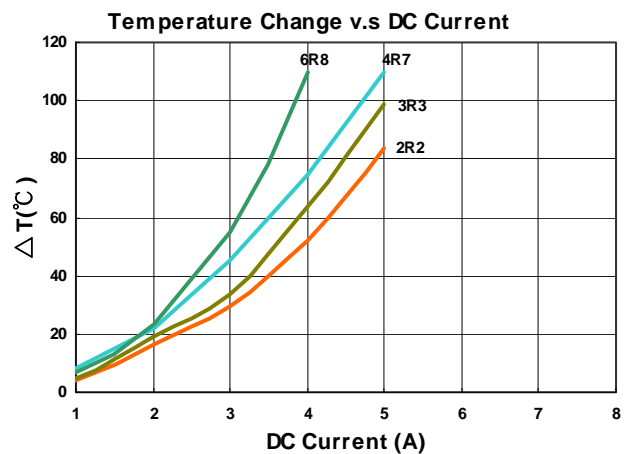
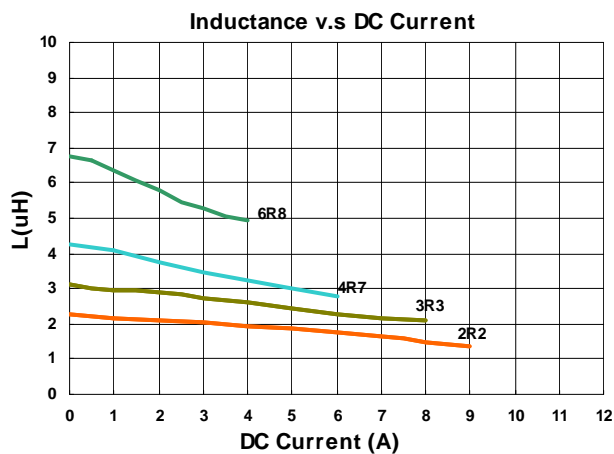

Electrical Characteristics

| Part Number | Inductance (uH) | Tolerance (±%) | Test Frequency (kHz) | RDC (mΩ)Max | Isat (A)Typ. | Irms (A)Typ. |
|--------------------|-----------------|----------------|----------------------|-------------|--------------|--------------|
| MHCI06015-1R0M-R8A | 1.0 | 20 | 100 | 21 | 9.0 | 5.5 |
| MHCI06015-3R3M-R8A | 3.3 | 20 | 100 | 63 | 5.5 | 3.3 |
| MHCI06015-100M-R8A | 10 | 20 | 100 | 175 | 3.0 | 2.0 |

Note: When ordering, please specify tolerance code. Tolerance: M=±20%

- Operating temperature range - 55°C ~ 125°C(Including self - temperature rise)
- Isat for Inductance drop 30% from its value with current
- I rms for a 40°C temperature rise from 25°C ambient with current
- Measure Equipment :
 L : WK 3260B or WK 6500P, 100kHz 0.5V
 RDC : CHEN HWA 502 or CHEN HWA 46502B

Test Instruments : WK3260B Impedance / Material Analyzer

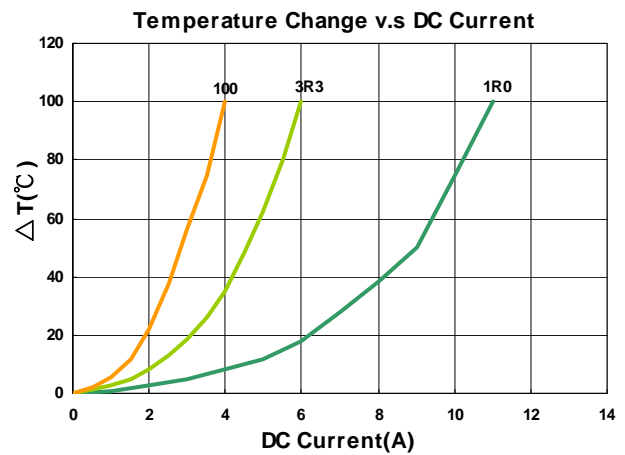
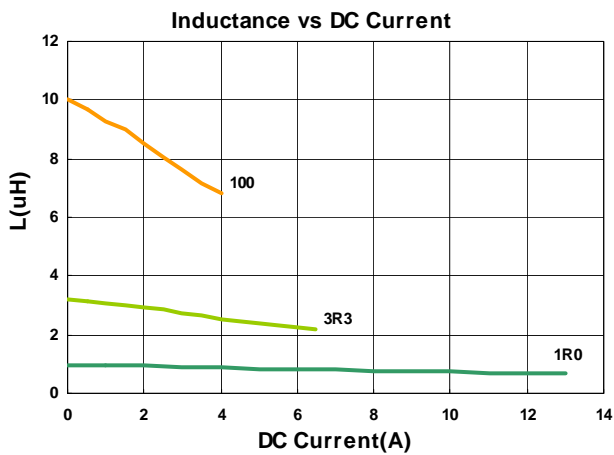

Electrical Characteristics

| Part Number | Inductance (uH) | Tolerance (±%) | Test Frequency (kHz) | RDC (mΩ)Max | Isat (A)Typ. | Irms (A)Typ. |
|--------------------|-----------------|----------------|----------------------|-------------|--------------|--------------|
| MHCI06018-R22M-R8A | 0.22 | 20 | 100 | 5.2 | 29 | 14 |
| MHCI06018-R33M-R8A | 0.33 | 20 | 100 | 6.8 | 22 | 12 |
| MHCI06018-R47M-R8A | 0.47 | 20 | 100 | 8.4 | 18 | 11 |
| MHCI06018-R68M-R8A | 0.68 | 20 | 100 | 12.7 | 17 | 9 |
| MHCI06018-1R0M-R8A | 1.0 | 20 | 100 | 17 | 14 | 7 |
| MHCI06018-1R5M-R8A | 1.5 | 20 | 100 | 26 | 12 | 6.5 |
| MHCI06018-2R2M-R8A | 2.2 | 20 | 100 | 35 | 10 | 6.0 |
| MHCI06018-4R7M-R8A | 4.7 | 20 | 100 | 70 | 5 | 3.5 |
| MHCI06018-6R8M-R8A | 6.8 | 20 | 100 | 110 | 3.5 | 2.8 |
| MHCI06018-100M-R8A | 10 | 20 | 100 | 155 | 2.5 | 2.3 |

Note: When ordering, please specify tolerance code. Tolerance: M=±20%

- Operating temperature range - 55°C ~ 125°C(Including self - temperature rise)
- Isat for Inductance drop 30% from its value with current
- I rms for a 40°C temperature rise from 25°C ambient with current
- Measure Equipment :
 L : WK 3260B or WK 6500P, 100kHz 0.5V
 RDC : CHEN HWA 502 or CHEN HWA 46502B

Test Instruments : WK3260B Impedance / Material Analyzer

Inductance vs DC Current

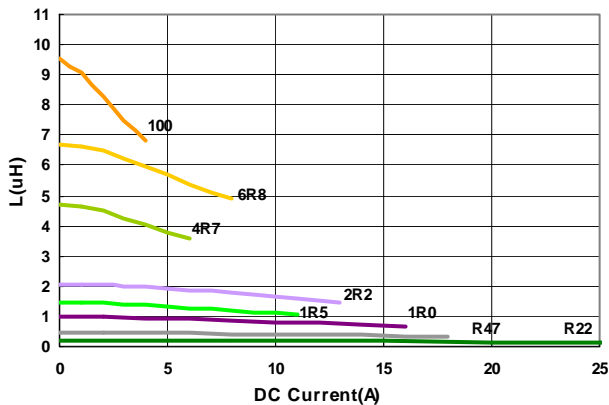

Temperature Change v.s DC Current

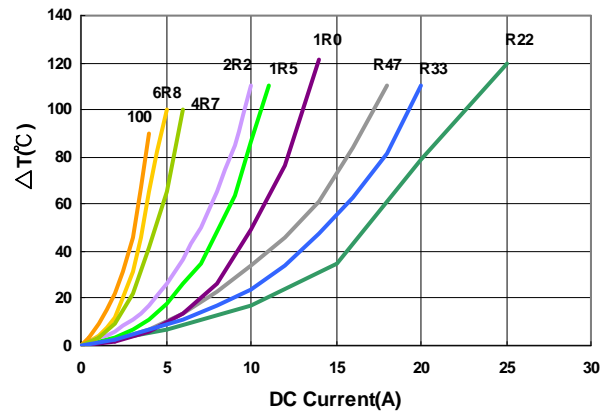

Electrical Characteristics

| Part Number | Inductance (uH) | Tolerance (±%) | Test Frequency (kHz) | RDC (mΩ)Max | Isat (A)Typ. | Irms (A)Typ. |
|--------------------|-----------------|----------------|----------------------|-------------|--------------|--------------|
| MHCI06024-R22M-R8A | 0.22 | 20 | 100 | 3.2 | 34 | 21 |
| MHCI06024-R33M-R8A | 0.33 | 20 | 100 | 4.1 | 24.5 | 18 |
| MHCI06024-R47M-R8A | 0.47 | 20 | 100 | 5.1 | 22 | 15 |
| MHCI06024-1R0M-R8A | 1.0 | 20 | 100 | 13.5 | 16 | 9 |
| MHCI06024-1R5M-R8A | 1.5 | 20 | 100 | 20 | 15 | 9 |
| MHCI06024-2R2M-R8A | 2.2 | 20 | 100 | 28 | 14 | 7 |
| MHCI06024-3R3M-R8A | 3.3 | 20 | 100 | 39 | 10 | 5.5 |
| MHCI06024-4R7M-R8A | 4.7 | 20 | 100 | 50 | 10 | 5.0 |
| MHCI06024-6R8M-R8A | 6.8 | 20 | 100 | 70 | 6.0 | 4.0 |
| MHCI06024-100M-R8A | 10 | 20 | 100 | 101 | 4.0 | 3.1 |
| MHCI06024-150M-R8A | 15 | 20 | 100 | 160 | 3.3 | 2.5 |

Note: When ordering, please specify tolerance code. Tolerance: M=±20%

- Operating temperature range - 55°C ~ 125°C(Including self - temperature rise)
- Isat for Inductance drop 30% from its value with current
- I rms for a 40°C temperature rise from 25°C ambient with current
- Measure Equipment :
 L : WK 3260B or WK 6500P, 100kHz 0.5V
 RDC : CHEN HWA 502 or CHEN HWA 46502B

Test Instruments : WK3260B Impedance / Material Analyzer

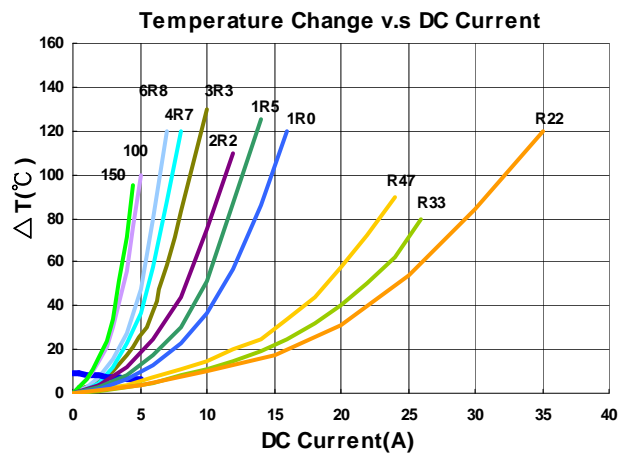
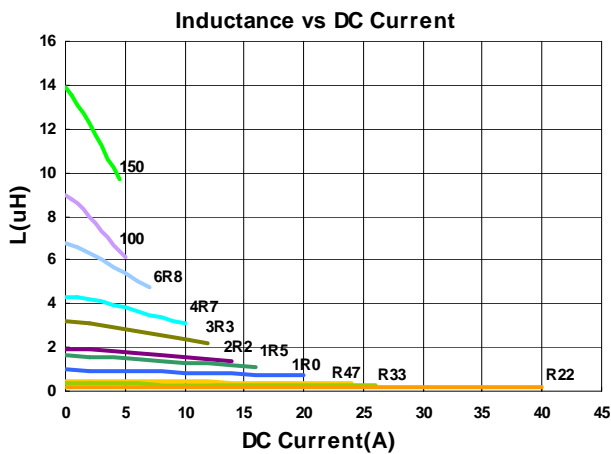

Electrical Characteristics

| Part Number | Inductance (uH) | Tolerance (±%) | Test Frequency (kHz) | RDC (mΩ) Max | Isat (A)Typ. | Irms (A)Typ. |
|-------------------|-----------------|----------------|----------------------|--------------|--------------|--------------|
| MHCI06030-R10M-R8 | 0.10 | 20 | 100 | 1.5 | 45 | 37 |
| MHCI06030-R22M-R8 | 0.22 | 20 | 100 | 2.8 | 40 | 23 |
| MHCI06030-R33M-R8 | 0.33 | 20 | 100 | 4.2 | 33 | 20 |
| MHCI06030-R47M-R8 | 0.47 | 20 | 100 | 5.5 | 27 | 16.5 |
| MHCI06030-R56M-R8 | 0.56 | 20 | 100 | 5.5 | 27 | 16.5 |
| MHCI06030-R68M-R8 | 0.68 | 20 | 100 | 6.3 | 24 | 15 |
| MHCI06030-R82M-R8 | 0.82 | 20 | 100 | 8.0 | 23 | 13 |
| MHCI06030-1R0M-R8 | 1.0 | 20 | 100 | 10 | 22 | 12 |
| MHCI06030-1R5M-R8 | 1.5 | 20 | 100 | 15 | 18 | 9.5 |
| MHCI06030-1R8M-R8 | 1.8 | 20 | 100 | 15 | 14 | 9.5 |
| MHCI06030-2R2M-R8 | 2.2 | 20 | 100 | 20 | 14 | 8.5 |
| MHCI06030-3R3M-R8 | 3.3 | 20 | 100 | 35 | 12 | 6.0 |
| MHCI06030-4R7M-R8 | 4.7 | 20 | 100 | 40 | 9 | 5.5 |
| MHCI06030-5R6M-R8 | 5.6 | 20 | 100 | 40 | 8 | 5.5 |
| MHCI06030-6R8M-R8 | 6.8 | 20 | 100 | 60 | 8 | 4.5 |
| MHCC06030-8R2M-R7 | 8.2 | 20 | 100 | 60 | 6 | 4.5 |
| MHCC06030-100M-R7 | 10 | 20 | 100 | 68 | 5.5 | 4.0 |
| MHCI06030-150M-R8 | 15 | 20 | 100 | 122 | 5.0 | 3.0 |
| MHCI06030-330M-R8 | 33 | 20 | 100 | 270 | 3.0 | 2.0 |

Note: When ordering, please specify tolerance code. Tolerance: M=±20%

- Operating temperature range - 55°C ~ 125°C(Including self - temperature rise)
- Isat for Inductance drop 30% from its value with current
- I rms for a 40°C temperature rise from 25°C ambient with current
- Measure Equipment :
 L : WK 3260B or WK 6500P, 100kHz 0.5V
 RDC : CHEN HWA 502 or CHEN HWA 46502B

Test Instruments : WK3260B Impedance / Material Analyzer

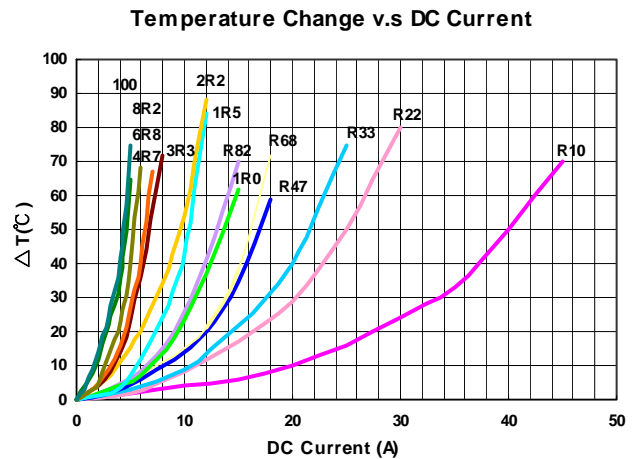
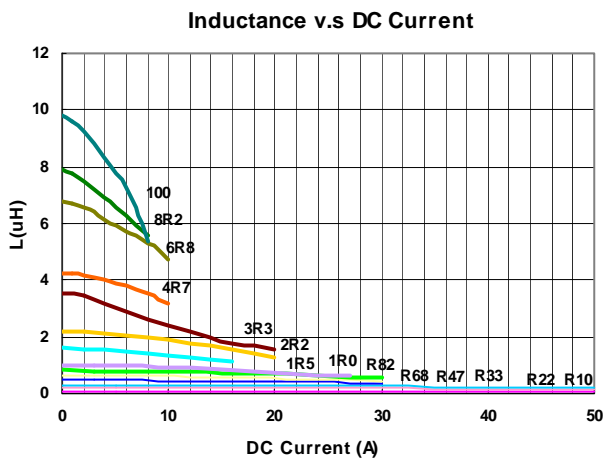

Electrical Characteristics

| Part Number | Inductance (uH) | Tolerance (±%) | Test Frequency (kHz) | RDC (mΩ)Max | Isat (A)Typ. | Irms (A)Typ. |
|--------------------|-----------------|----------------|----------------------|-------------|--------------|--------------|
| MHCI06030-R10M-R8A | 0.10 | 20 | 100 | 1.7 | 60 | 32.5 |
| MHCI06030-R15M-R8A | 0.15 | 20 | 100 | 2.5 | 60 | 30 |
| MHCI06030-R22M-R8A | 0.22 | 20 | 100 | 3.0 | 34 | 23 |
| MHCI06030-R33M-R8A | 0.33 | 20 | 100 | 3.5 | 25 | 21 |
| MHCI06030-R36M-R8A | 0.36 | 20 | 100 | 3.9 | 24 | 20 |
| MHCI06030-R47M-R8A | 0.47 | 20 | 100 | 4.1 | 20 | 18 |
| MHCI06030-R56M-R8A | 0.56 | 20 | 100 | 4.5 | 18 | 16.5 |
| MHCI06030-R68M-R8A | 0.68 | 20 | 100 | 5.3 | 17 | 16 |
| MHCI06030-R82M-R8A | 0.82 | 20 | 100 | 6.0 | 16 | 14 |
| MHCI06030-1R0M-R8A | 1.0 | 20 | 100 | 7.4 | 15 | 12 |
| MHCI06030-1R2M-R8A | 1.2 | 20 | 100 | 10 | 14 | 10 |
| MHCI06030-1R5M-R8A | 1.5 | 20 | 100 | 12.1 | 14 | 10 |
| MHCI06030-2R2M-R8A | 2.2 | 20 | 100 | 15 | 10 | 8 |
| MHCI06030-3R3M-R8A | 3.3 | 20 | 100 | 22 | 9.5 | 6.5 |
| MHCI06030-4R7M-R8A | 4.7 | 20 | 100 | 33 | 6.5 | 5.5 |
| MHCI06030-6R8M-R8A | 6.8 | 20 | 100 | 50 | 6 | 4.5 |
| MHCI06030-100M-R8A | 10 | 20 | 100 | 68 | 5.5 | 4 |

Note: When ordering, please specify tolerance code. Tolerance: M=±20%

- Operating temperature range - 55°C ~ 125°C(Including self - temperature rise)
- Isat for Inductance drop 30% from its value with current
- I rms for a 40°C temperature rise from 25°C ambient with current
- Measure Equipment :
 L : WK 3260B or WK 6500P, 100kHz 0.5V
 RDC : CHEN HWA 502 or CHEN HWA 46502B

Test Instruments : WK3260B Impedance / Material Analyzer

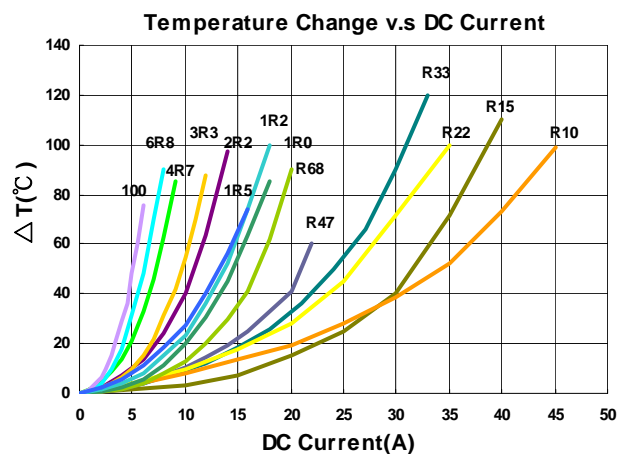
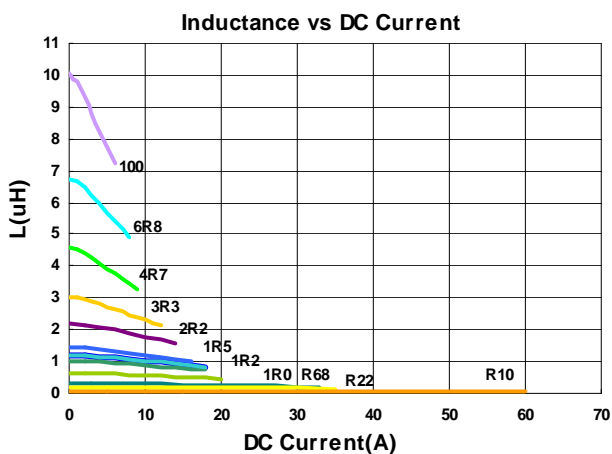

Electrical Characteristics

| Part Number | Inductance (uH) | Tolerance (±%) | Test Frequency (kHz) | RDC (mΩ) Max | Isat (A)Typ. | Irms (A)Typ. |
|--------------------|-----------------|----------------|----------------------|--------------|--------------|--------------|
| MHCI06050-R56M-R8A | 0.56 | 20 | 100 | 3.3 | 20 | 20 |
| MHCI06050-1R0M-R8A | 1.0 | 20 | 100 | 6.5 | 15 | 13 |
| MHCI06050-2R2M-R8A | 2.2 | 20 | 100 | 12.5 | 12 | 8 |
| MHCI06050-3R3M-R8A | 3.3 | 20 | 100 | 20.9 | 9 | 7 |
| MHCI06050-4R7M-R8A | 4.7 | 20 | 100 | 25.0 | 7 | 6.5 |

Note: When ordering, please specify tolerance code. Tolerance: M=±20%

- Operating temperature range - 55°C ~ 125°C(Including self - temperature rise)
- Isat for Inductance drop 30% from its value with current
- I rms for a 40°C temperature rise from 25°C ambient with current
- Measure Equipment :
L : WK 3260B or WK 6500P, 100kHz 0.5V
RDC : CHEN HWA 502 or CHEN HWA 46502B

Test Instruments : WK3260B Impedance / Material Analyzer

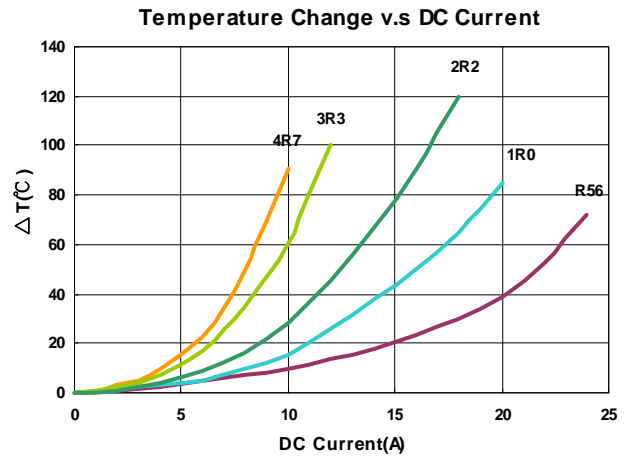
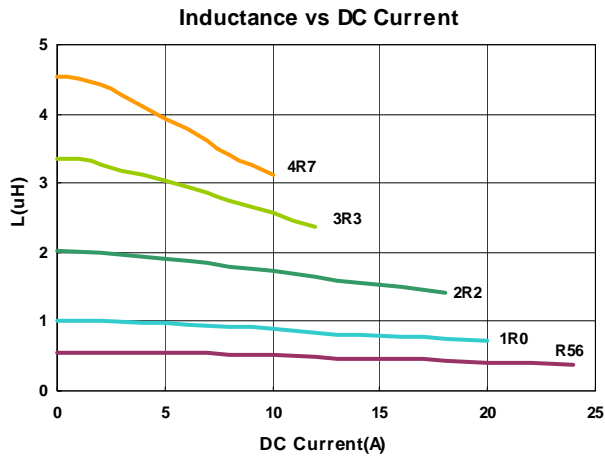

Electrical Characteristics

| Part Number | Inductance (uH) | Tolerance (±%) | Test Frequency (kHz) | RDC (mΩ) Max | Isat (A)Typ. | Irms (A)Typ. |
|--------------------|-----------------|----------------|----------------------|--------------|--------------|--------------|
| MHCC10030-R33M-R7A | 0.33 | 20 | 100 | 1.6 | 32 | 23 |
| MHCC10030-1R0M-R7A | 1.0 | 20 | 100 | 6.0 | 21 | 15 |
| MHCC10030-3R3M-R7A | 3.3 | 20 | 100 | 16.0 | 14 | 9 |

Note: When ordering, please specify tolerance code. Tolerance: M=±20%

- Operating temperature range - 55°C ~ 125°C(Including self - temperature rise)
- Isat for Inductance drop 30% from its value with current
- I rms for a 40°C temperature rise from 25°C ambient with current
- Measure Equipment :
 L : WK 3260B or WK 6500P, 100kHz 0.5V
 RDC : CHEN HWA 502 or CHEN HWA 46502B

Test Instruments : WK3260B Impedance / Material Analyzer

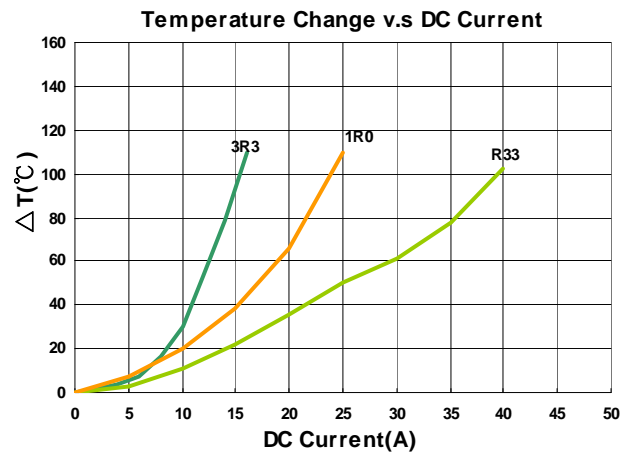
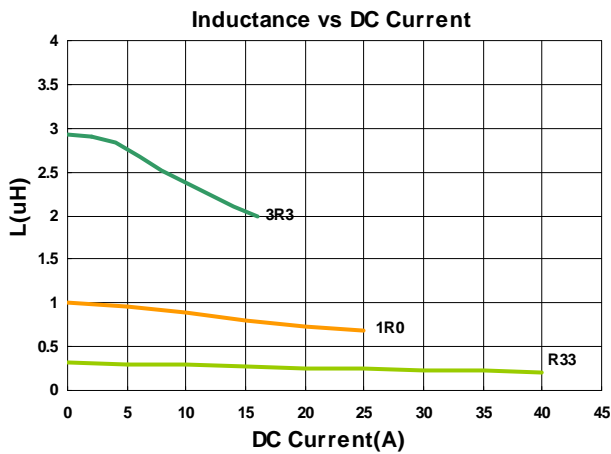

Electrical Characteristics

| Part Number | Inductance (uH) | Tolerance (±%) | Test Frequency (kHz) | RDC (mΩ) Max | Isat (A)Typ. | Irms (A)Typ. |
|-------------------|-----------------|----------------|----------------------|--------------|--------------|--------------|
| MHCC10040-R22M-R7 | 0.22 | 20 | 100 | 0.6 | 45 | 35 |
| MHCC10040-R36M-R7 | 0.36 | 20 | 100 | 1.2 | 42 | 34 |
| MHCC10040-R45M-R7 | 0.45 | 20 | 100 | 1.2 | 38 | 33 |
| MHCC10040-R47M-R7 | 0.47 | 20 | 100 | 1.2 | 38 | 33 |
| MHCC10040-R56M-R7 | 0.56 | 20 | 100 | 1.55 | 32 | 27 |
| MHCC10040-R68M-R7 | 0.68 | 20 | 100 | 1.55 | 30 | 27 |
| MHCC10040-1R0M-R7 | 1.0 | 20 | 100 | 3.1 | 26 | 20 |
| MHCC10040-1R5M-R7 | 1.5 | 20 | 100 | 4.2 | 22 | 16 |
| MHCC10040-1R8M-R7 | 1.8 | 20 | 100 | 5 | 16 | 15.3 |
| MHCC10040-2R2M-R7 | 2.2 | 20 | 100 | 7 | 16 | 14 |
| MHCC10040-3R3M-R7 | 3.3 | 20 | 100 | 13.2 | 12 | 11 |
| MHCC10040-4R7M-R7 | 4.7 | 20 | 100 | 16.5 | 12 | 9 |
| MHCC10040-6R8M-R7 | 6.8 | 20 | 100 | 25 | 10 | 6 |
| MHCC10040-8R2M-R7 | 8.2 | 20 | 100 | 30 | 9 | 6 |
| MHCC10040-100M-R7 | 10 | 20 | 100 | 30 | 7 | 6.5 |
| MHCC10040-150M-R7 | 15 | 20 | 100 | 45 | 6 | 6.25 |
| MHCC10040-220M-R7 | 22 | 20 | 100 | 72 | 5.5 | 5 |

Note: When ordering, please specify tolerance code. Tolerance: M=±20%

- Operating temperature range - 55°C ~ 125°C(Including self - temperature rise)
- Isat for Inductance drop 30% from its value with current
- I rms for a 40°C temperature rise from 25°C ambient with current
- Measure Equipment :
 L : WK 3260B or WK 6500P, 100kHz 0.5V
 RDC : CHEN HWA 502 or CHEN HWA 46502B

Test Instruments : WK3260B Impedance / Material Analyzer

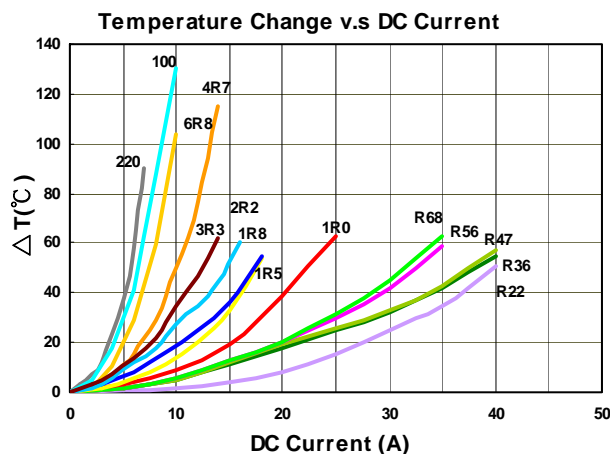
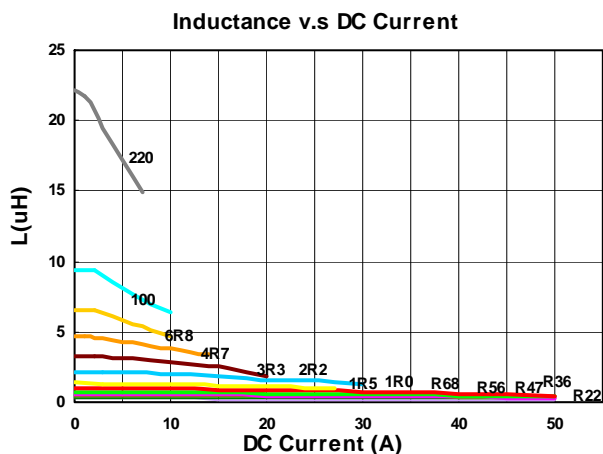

Electrical Characteristics

| Part Number | Inductance (uH) | Tolerance (±%) | Test Frequency (kHz) | RDC (mΩ) Max | Isat (A)Typ. | Irms (A)Typ. |
|-------------------|-----------------|----------------|----------------------|--------------|--------------|--------------|
| MHCC12050-R47M-R7 | 0.47 | 20 | 100 | 1.2 | 46 | 37 |
| MHCC12050-1R0M-R7 | 1.0 | 20 | 100 | 2.5 | 37 | 29 |
| MHCC12050-1R5M-R7 | 1.5 | 20 | 100 | 3.0 | 28 | 28 |
| MHCC12050-4R7M-R7 | 4.7 | 20 | 100 | 11.5 | 16 | 11 |
| MHCC12050-6R8M-R7 | 6.8 | 20 | 100 | 22 | 14 | 9 |
| MHCC12050-100M-R7 | 10 | 20 | 100 | 35 | 13 | 7 |

Note: When ordering, please specify tolerance code. Tolerance: M=±20%

- Operating temperature range - 55°C ~ 125°C(Including self - temperature rise)
- Isat for Inductance drop 30% from its value with current
- I rms for a 40°C temperature rise from 25°C ambient with current
- Measure Equipment :
 L : WK 3260B or WK 6500P, 100kHz 0.5V
 RDC : CHEN HWA 502 or CHEN HWA 46502B

Test Instruments : WK3260B Impedance / Material Analyzer

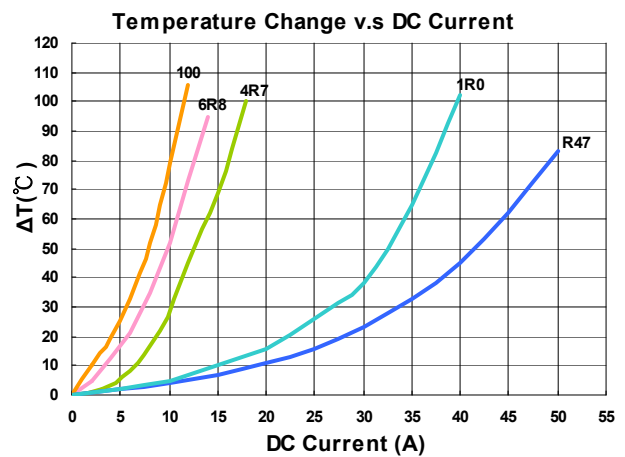
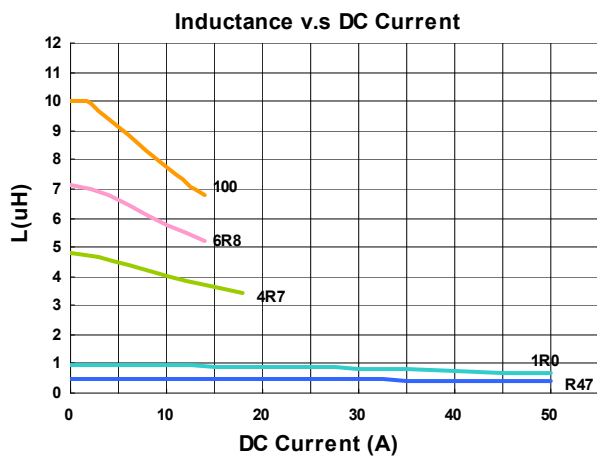

Molding Power Choke – MHCC/MHCI Series

Electrical Characteristics

| Part Number | Inductance (uH) | Tolerance (±%) | Test Frequency (kHz) | RDC (mΩ) Max | Isat (A)Typ. | Irms (A)Typ. |
|--------------------|-----------------|----------------|----------------------|--------------|--------------|--------------|
| MHCC12060-100M-R7A | 10 | 20 | 100 | 20.7 | 12.5 | 10 |
| MHCC12060-150M-R7A | 15 | 20 | 100 | 29.0 | 9.0 | 6.0 |
| MHCC12060-220M-R7A | 22 | 20 | 100 | 39.5 | 7.5 | 5.0 |
| MHCC12060-330M-R7A | 33 | 20 | 100 | 75 | 6.0 | 4.0 |
| MHCC12060-680M-R7A | 68 | 20 | 100 | 140 | 4.5 | 3.0 |

Note: When ordering, please specify tolerance code. Tolerance: M=±20%

- Operating temperature range - 55°C ~ 125°C(Including self - temperature rise)
- Isat for Inductance drop 30% from its value with current
- I rms for a 40°C temperature rise from 25°C ambient with current
- Measure Equipment :
L : WK 3260B or WK 6500P, 100kHz 0.5V
RDC : CHEN HWA 502 or CHEN HWA 46502B

Test Instruments : WK3260B Impedance / Material Analyzer

Inductance vs DC Current

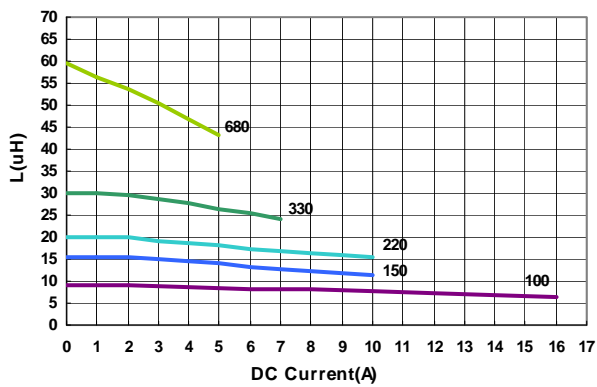

Temperature Change v.s DC Current

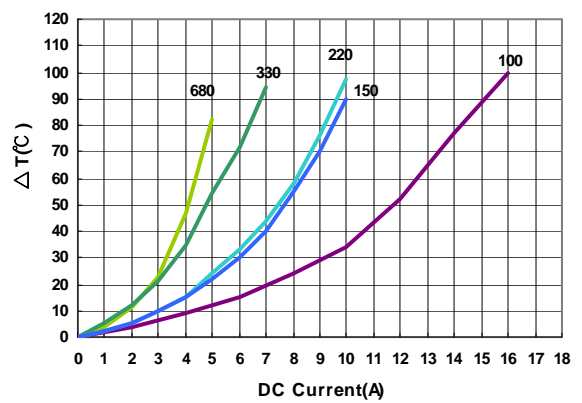

Packaging Specifications

Tape Dimensions

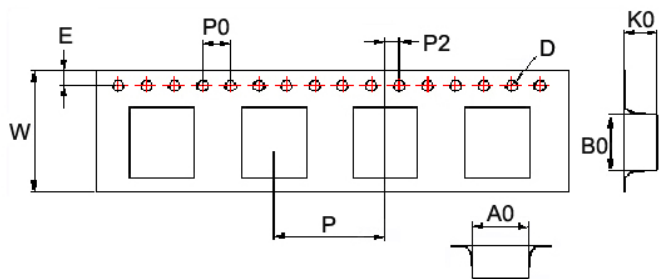

Tape Material

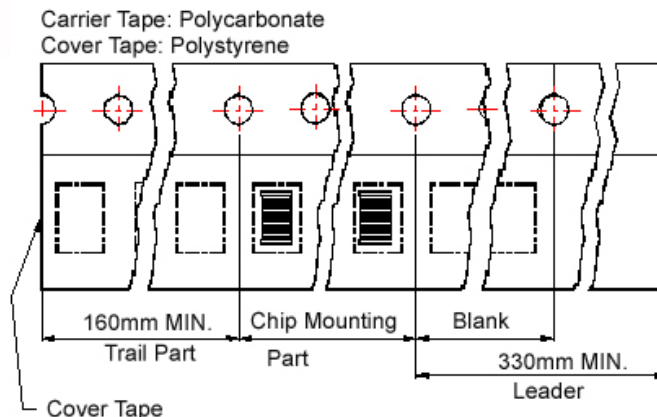

Reel Dimensions

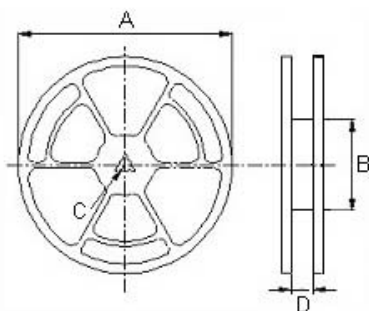

Dimensions in mm

| TYPE | Tape Dimensions | | | | | | | | | Reel Dimensions | | | | Quantity |
|-------|-----------------|------|------|------|------|----|----|----|----|-----------------|-----|----|------|------------|
| | A0 | B0 | K0 | D | E | W | P | P0 | P2 | A | B | C | D | PCS / REEL |
| 04012 | 4.6 | 5.0 | 1.5 | 1.55 | 1.75 | 12 | 8 | 4 | 2 | 330 | 100 | 13 | 13.4 | 2000 |
| 04015 | 4.4 | 4.9 | 1.8 | 1.55 | 1.75 | 12 | 8 | 4 | 2 | 330 | 100 | 13 | 13.4 | 2000 |
| 04020 | 4.3 | 4.9 | 2.4 | 1.55 | 1.75 | 12 | 8 | 4 | 2 | 330 | 100 | 13 | 13.4 | 2000 |
| 05012 | 5.9 | 6.2 | 1.5 | 1.55 | 1.75 | 16 | 12 | 4 | 2 | 330 | 100 | 13 | 16.0 | 1000 |
| 05015 | 5.7 | 6.1 | 1.9 | 1.55 | 1.75 | 16 | 12 | 4 | 2 | 330 | 100 | 13 | 16.0 | 1000 |
| 05018 | 5.9 | 6.2 | 2.2 | 1.55 | 1.75 | 16 | 12 | 4 | 2 | 330 | 100 | 13 | 16.0 | 1000 |
| 05020 | 5.7 | 5.9 | 2.4 | 1.55 | 1.75 | 16 | 12 | 4 | 2 | 330 | 100 | 13 | 16.0 | 1000 |
| 05030 | 5.9 | 6.2 | 3.4 | 1.55 | 1.75 | 16 | 12 | 4 | 2 | 330 | 100 | 13 | 16.0 | 1000 |
| 06012 | 6.9 | 7.6 | 1.6 | 1.55 | 1.75 | 16 | 12 | 4 | 2 | 330 | 100 | 13 | 16.0 | 1000 |
| 06015 | 6.9 | 7.6 | 1.9 | 1.55 | 1.75 | 16 | 12 | 4 | 2 | 330 | 100 | 13 | 16.0 | 1000 |
| 06018 | 6.9 | 7.6 | 2.2 | 1.55 | 1.75 | 16 | 12 | 4 | 2 | 330 | 100 | 13 | 16.0 | 1000 |
| 06024 | 6.9 | 7.6 | 2.9 | 1.55 | 1.75 | 16 | 12 | 4 | 2 | 330 | 100 | 13 | 16.0 | 1000 |
| 06030 | 6.9 | 7.6 | 3.4 | 1.55 | 1.75 | 16 | 12 | 4 | 2 | 330 | 100 | 13 | 16.0 | 1000 |
| 06050 | 6.9 | 7.6 | 5.4 | 1.55 | 1.75 | 16 | 12 | 4 | 2 | 330 | 100 | 13 | 16.0 | 500 |
| 10030 | 10.6 | 11.7 | 3.25 | 1.55 | 1.75 | 24 | 16 | 4 | 2 | 330 | 100 | 13 | 24.4 | 500 |
| 10040 | 10.6 | 11.7 | 4.25 | 1.55 | 1.75 | 24 | 16 | 4 | 2 | 330 | 100 | 13 | 24.4 | 500 |
| 12050 | 13 | 14 | 5.25 | 1.55 | 1.75 | 24 | 16 | 4 | 2 | 330 | 100 | 13 | 24.4 | 500 |
| 12060 | 13 | 14 | 6.25 | 1.55 | 1.75 | 24 | 16 | 4 | 2 | 330 | 100 | 13 | 24.4 | 500 |