

Products for tomorrow...

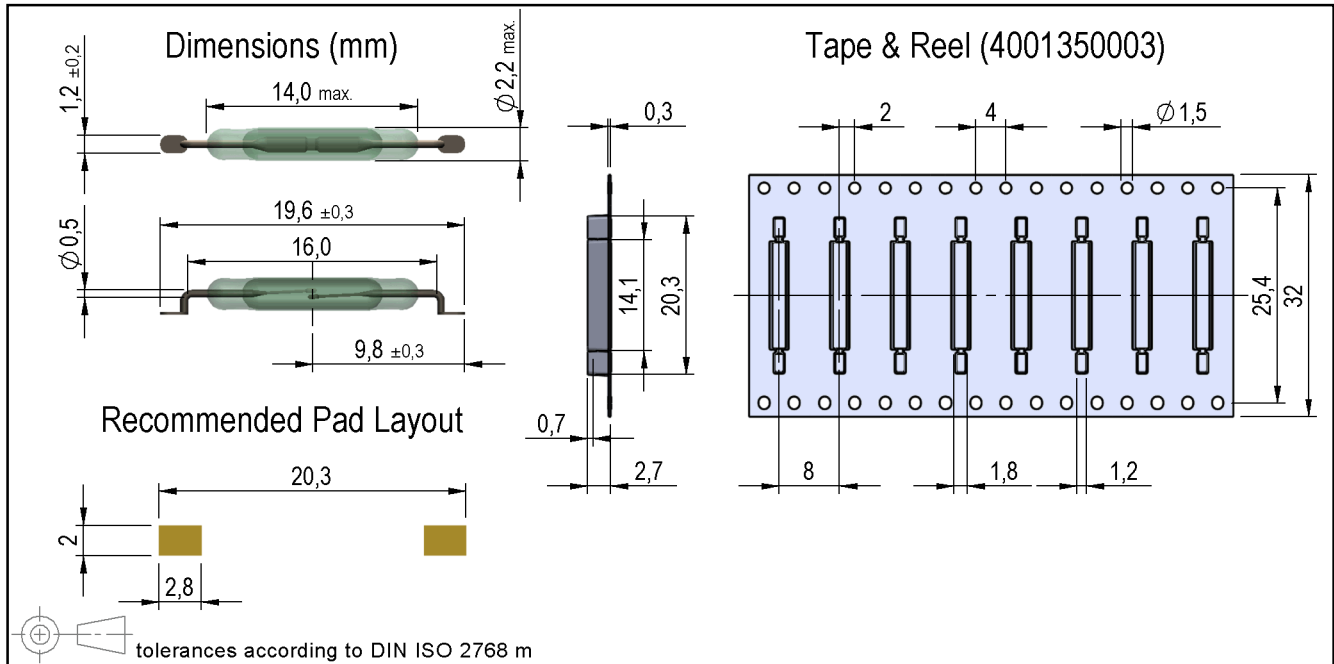

Magnetic properties	Conditions	Min	Typ	Max	Unit
Pull-In excitation (Reference value)	Reed switch unmodified measured in coil- "define operation"	20		25	AT
Test-Coil	Reed switch unmodified	KMS-01			
Pull-In excitation (modified contact)	Reed switch modified phys. conditioned tolerance of +/- 1 AT	40		46	AT
Test-Coil	Reed switch modified	KMS-21			
Pull-In in milliTesla (modified conta	MS150 - phys. caused tolerance +/- 0,1mT	2,01		2,51	mT

Contact data 66	Conditions	Min	Typ	Max	Unit
Contact-No.		66			
Contact-form		A			
Contact-material		Rhodium			
Contact rating	Any DC combination of V & A not to exceed their individual max.'s			10	W
Switching voltage (>20 AT)	DC or Peak AC			200	V
Switching current	DC or Peak AC			0,5	A
Carry current	DC or Peak AC			1,25	A
Contact resistance static	Measured with 40% overdrive Start Value			150	mOhm
Contact resistance dynamic	Maximum value 1,5 ms after excitation Start Value			200	mOhm
Insulation resistance	RH <45 %, 100 VDC test voltage	10			GOhm
Breakdown voltage (>20 AT)	according to IEC 255-5	225			VDC
Operate time incl. bounce	measured with 40% overdrive			0,5	ms
Release time	measured with no coil excitation			0,1	ms
Capacity			0,2		pF

Modified dimensions	Conditions	Min	Typ	Max	Unit
Remarks		to dimensions see drawing			

Environmental data	Conditions	Min	Typ	Max	Unit
Shock	1/2 Sinuswelle, Dauer 11ms			50	g
Vibration	von 10 - 2000 Hz			20	g
Ambient temperature		-40		130	°C
Storage temperature		-55		130	°C
Soldering temperature	Wellenlöten max. 5 Sek.			260	°C

Modifications in the sense of technical progress are reserved

Designed at: 05.02.08 Designed by: AKELLER
 Last Change at: 09.07.09 Last Change by: AKELLER

Approval at: 05.02.08 Approval by: RKAMP
 Approval at: 09.07.09 Approval by: RKAMP

Version: 07