

Product Features

- GaN on SiC Broadband High Power Amplifier
- 450 ~ 880MHz Operation Bandwidth
- Small Signal Gain 38dB min.
- 40W Typical. @ P3dB

Applications

- General Purpose



Package Type : DP-75

Description

The power amplifier module is designed for Broadcasting, Telecommunication, Medical and Other markets.

Operating frequency range is from 450 ~ 880MHz.

Gallium Nitride on SiC technology is used and attached on an aluminum sub carrier. Full in/out matching for broadband performance is already applied.

Improved thermal handling by patented technology.

Electrical Specifications @ $V_{CC} = 28V$; $T_c = 45^\circ C$; $Z_S = Z_L = 50\Omega$

PARAMETER	UNIT	MIN	TYP	MAX	CONDITION	
Operating Frequency	MHz	450	-	880	-	
Small Signal Gain	dB	38	40	42	-	
Gain Variation vs Frequency	dBpp	-	± 1	± 2	-	
P_3 dB	dBm	44	45	-	450 ~ 880MHz	
OIP3 @ $P_o = +33dBm$ (1MHz Tone spacing, CW 2-Tone)	dBm	49	51	-	450 ~ 880 MHz	
Input Return Loss	dB	-	-12	-10	-	
ACLR@Pout=28dBm W-CDMA,64PCH,4FA Spectrum Analyzer Setting : RBW=30KHz, VBW=10KHz	dBc	45	48	-	450MHz	$\Delta = 5MHz$
		48	51	-		$\Delta = 10MHz$
		44	45	-	880MHz	$\Delta = 5MHz$
		47	48	-		$\Delta = 10MHz$
Supply Voltage	V	27.5	28	30	$V_{cc}(=V_{ds})$	
Quiescent Current consumption	A	-	2.5	2.7	-	
On/Off Switching Time*	uS	-	3.0	5.0	On : TTL "Low"	
					Off : TTL "High"(30mA@Disable)	
Shut Down or Switch On/Off TTL Voltage**	V	0	-	0.5	On : TTL "Low"(Enable)	
		2.5	5	5.5	Off : TTL "High"	

Note.

*. Gate On/Off : High speed switching

** . Drain On/Off : 500ms delay

Absolute Maximum Ratings

PARAMETER	UNIT	RATING
Input RF Power	dBm	12
Supply Voltage	V	30
Load Mismatch Value	-	3 : 1 @all load phase

* Input Signal Condition : CW 1-Tone

Environmental Characteristics

PARAMETER	UNIT	MIN	TYP	MAX	SYMBOL
Operating Case Temperature	°C	-10	-	80	Tc
Storage Temperature	°C	-40	-	105	Tstg
Vibration	MIL-STD-810G Method 514.6 ANNEX C				VI

Ordering Information

Part Number	Package
RWP06040-10	Pallet
RWP06040-1H	Module assembled with RWP06040-10

* RWP06040-1H is a SMA connectorized housing version of RWP06040-10. Electrical parameters are all same as RWP06040-10.
For more information, please contact RFHIC.

Mechanical Specifications

PARAMETER		UNIT	TYP
Dimension	Package	mm	70(L) x 50.8(W) x 17.1(H)
	Housing		90(L) x 75(W) x 25(H)
Weight	Package	g	55
	Housing		250
Housing RF IN/OUT Connector		-	SMA Female
Cooling		-	External Heat-sink

Typical Performance @ 25°C

Frequency (MHz)	P1dB (dBm)	P3dB (dBm)	Current @P1dB (A)	Current @P3dB (A)	OIP3 (30dBm/Tone) (dBm)	W-CDMA 64CH 4FA @ 28dBm			
						-5MHz	+5MHz	-10MHz	+10MHz
						(dBc)			
450	44.4	45.6	2.3	2.4	51.6	-48.0	-48.1	-50.8	-51.0
550	42.5	44.9	2.4	3.1	50.8	-46.3	-46.4	-49.1	-49.3
650	42.5	44.9	2.4	3.2	50.2	-45.4	-45.7	-48.1	-48.6
750	43.0	45.4	2.5	3.0	50.5	-45.7	-46.1	-48.4	-48.9
880	43.1	45.4	2.5	3.0	50.3	-45.5	-46.0	-48.2	-48.8

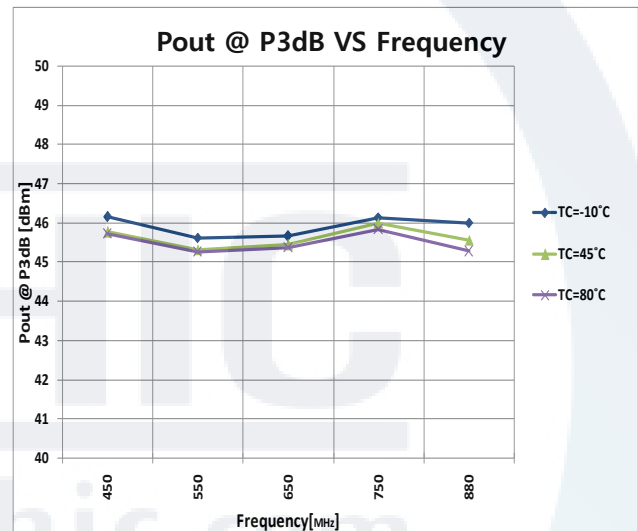
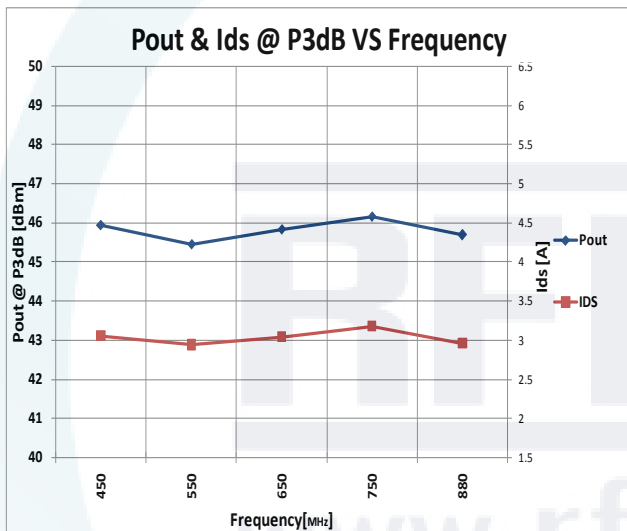

W-CDMA, 64PCH, 4FA ACLR, PAPR 11.3dB

Agilent 15:44:17 Apr 22, 2009

Ch Freq 450 MHz Trig Free

Multi-Carrier Power Averages: 10

Ref 8.502 dBm #Atten 12 dB

Center 450.00 MHz Span 50 MHz
#Res BW 30 kHz #VBW 10 kHz Sweep 441.6 ms (601 pts)

	Total Carrier Power	Ref Carrier Power	Offset Freq	Integ BW	dBc	Lower	dBm	dBc	Upper	dBm
	27.79 dBm / 15.3600 MHz	21.81 dBm / 3.84000 MHz								
1	21.93 dBm		5.000 MHz	3.840 MHz	-49.77		-27.95	-50.34		-28.52
2	21.81 dBm		10.00 MHz	3.840 MHz	-52.47		-30.65	-53.26		-31.44
3	21.75 dBm		15.00 MHz	3.840 MHz	-56.69		-34.87	-57.65		-35.83

File Operation Status, A:\STATE208.STA file saved

System

Show Errors

Power On/ Preset

Time/Date

Alignments

Config I/O

Reference

More
1 of 3

Agilent 15:44:54 Apr 22, 2009

Ch Freq 550.244 MHz Trig Free

Multi-Carrier Power Averages: 6

Center 550.2442000 MHz

Ref 8.415 dBm #Atten 14 dB

Center 550.24 MHz Span 48.84 MHz
#Res BW 30 kHz #VBW 10 kHz Sweep 431.4 ms (601 pts)

	Total Carrier Power	Ref Carrier Power	Offset Freq	Integ BW	dBc	Lower	dBm	dBc	Upper	dBm
	27.99 dBm / 15.3600 MHz	22.18 dBm / 3.84000 MHz								
1	22.40 dBm		5.000 MHz	3.840 MHz	-47.71		-25.53	-48.34		-26.16
2	22.18 dBm		10.00 MHz	3.840 MHz	-50.37		-28.20	-51.29		-29.12
3	21.83 dBm		15.00 MHz	3.840 MHz	-54.50		-32.33	-55.85		-33.68

File Operation Status, A:\SCREEN209.GIF file saved

Meas Setup

Avg Number 10
On Off

Avg Mode Exp Repeat

Carrier Setup

Offset/Limits

Carrier Result 1

Optimize Ref Level

More
1 of 2

Agilent 15:45:31 Apr 22, 2009

Ch Freq 650 MHz Trig Free

Multi-Carrier Power Averages: 5

Center 650.0000000 MHz

Ref 9.65 dBm #Atten 12 dB

Center 650.00 MHz Span 48.84 MHz
#Res BW 30 kHz #VBW 10 kHz Sweep 431.4 ms (601 pts)

	Total Carrier Power	Ref Carrier Power	Offset Freq	Integ BW	dBc	Lower	dBm	dBc	Upper	dBm
	27.98 dBm / 15.3600 MHz	22.24 dBm / 3.84000 MHz								
1	22.24 dBm		5.000 MHz	3.840 MHz	-46.63		-24.39	-47.29		-25.05
2	22.04 dBm		10.00 MHz	3.840 MHz	-49.43		-27.19	-50.17		-27.93
3	21.88 dBm		15.00 MHz	3.840 MHz	-53.74		-31.49	-54.61		-32.36

File Operation Status, A:\SCREEN210.GIF file saved

Meas Setup

Avg Number 10
On Off

Avg Mode Exp Repeat

Carrier Setup

Offset/Limits

Carrier Result 1

Optimize Ref Level

More
1 of 2

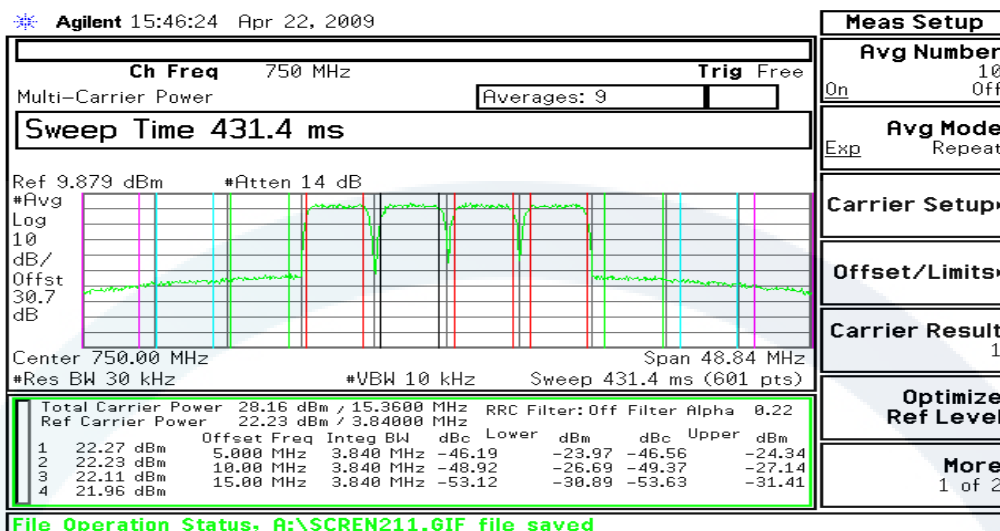

Meas Setup

Avg Number 10
On Off

Avg Mode Repeat
Exp

Carrier Setup

Offset/Limits

Carrier Result
1

Optimize Ref Level

More
1 of 2

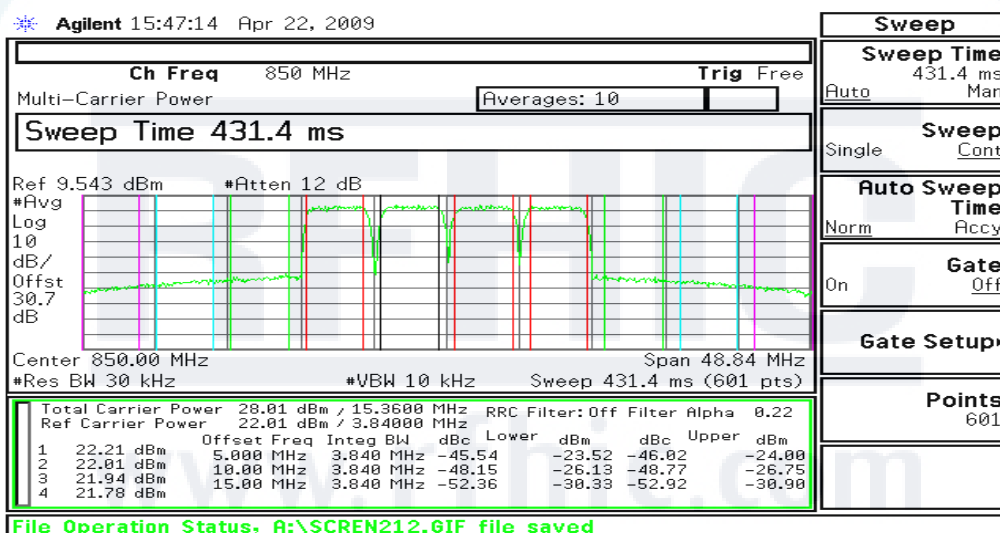

Sweep

Sweep Time 431.4 ms
Auto Man

Sweep Cont
Single Cont

Auto Sweep Time
Norm Accy

Gate
On Off

Gate Setup

Points
601

Precautions

1. This product is designed to be used for broadband amplification. Heat generation is higher when there is no RF signal in the device. Therefore, the worst case scenario is when there is no RF signal, and the amplifier is "on" with current draw. The temperature must be calculated properly. Case temperature must maintain below 80°C. Right side drawing notes how to use a temperature monitoring function to protect against overheating.
2. Thermal Grease or Metal Thermal Interface Materials are recommended for heat dissipation. An example would be spreading thermal grease on the bottom of the device

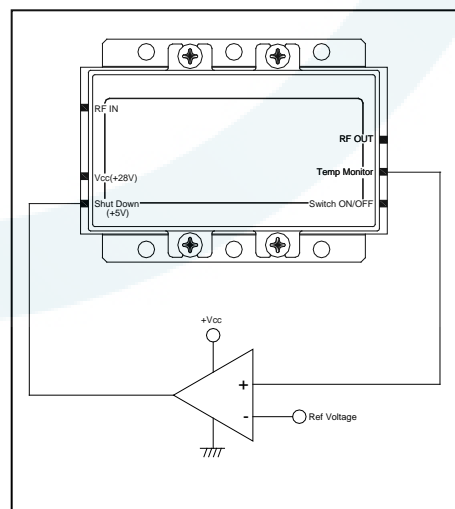

Comparator Block (with hysteresis gap)

Package Dimensions (Type: DP-75)

* Unit: mm[inch] | Tolerance: ±0.2[.008]

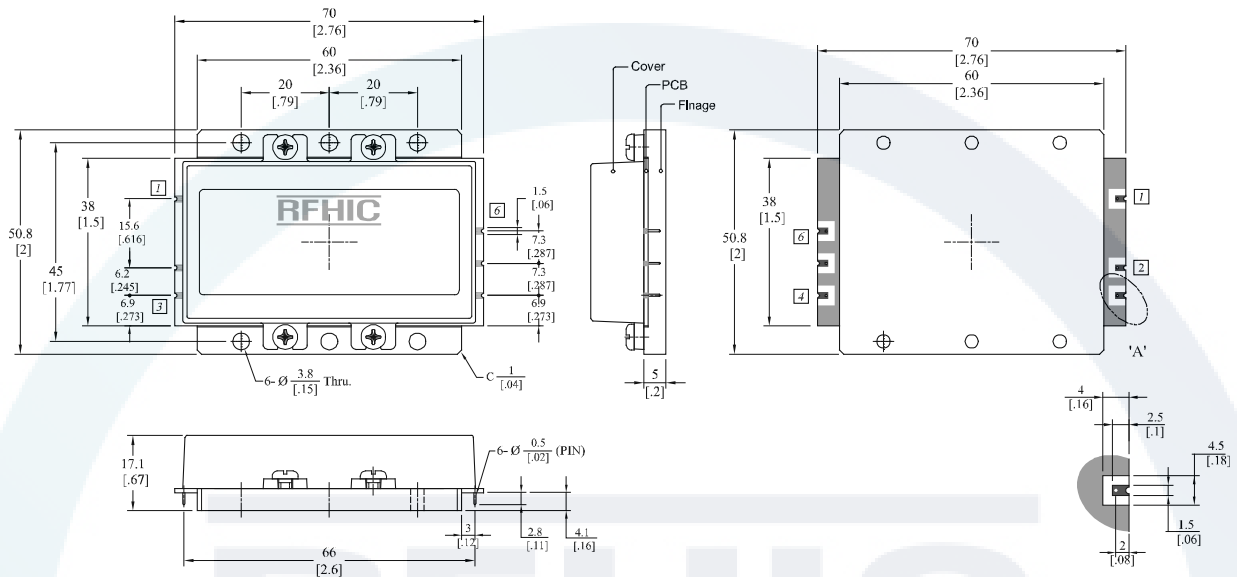

Pin Description			
Pin No	Function	Pin No	Function
1	RF IN	4	Switch ON/OFF
2	Vcc(+28V)	5	Temp Monitor
3	Shut Down(+5V)	6	RF OUT

* Terminal Pin Information : ASK206091,AA (Acethink, Pin) , ASK20556,AA-1(Acethink, Pin Socket)

* Recommended Screw Torque : 8.0kgf.cm±1 using SEMS M3 10mm Bolt

How to connected the package to a target PCB

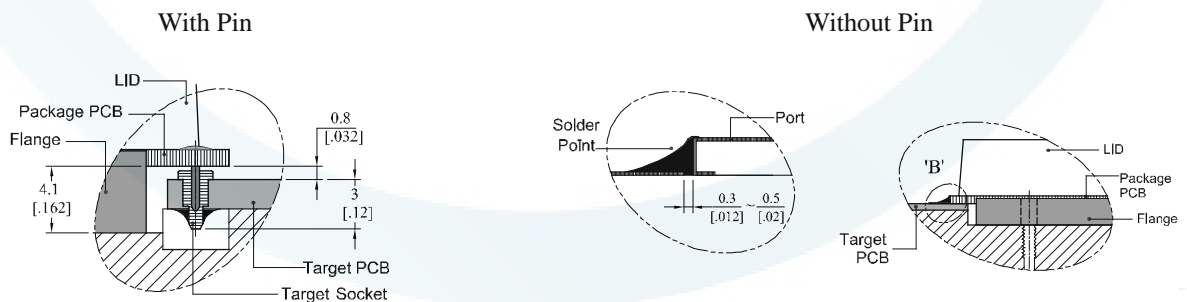

SMA Connectorized Housing Dimensions

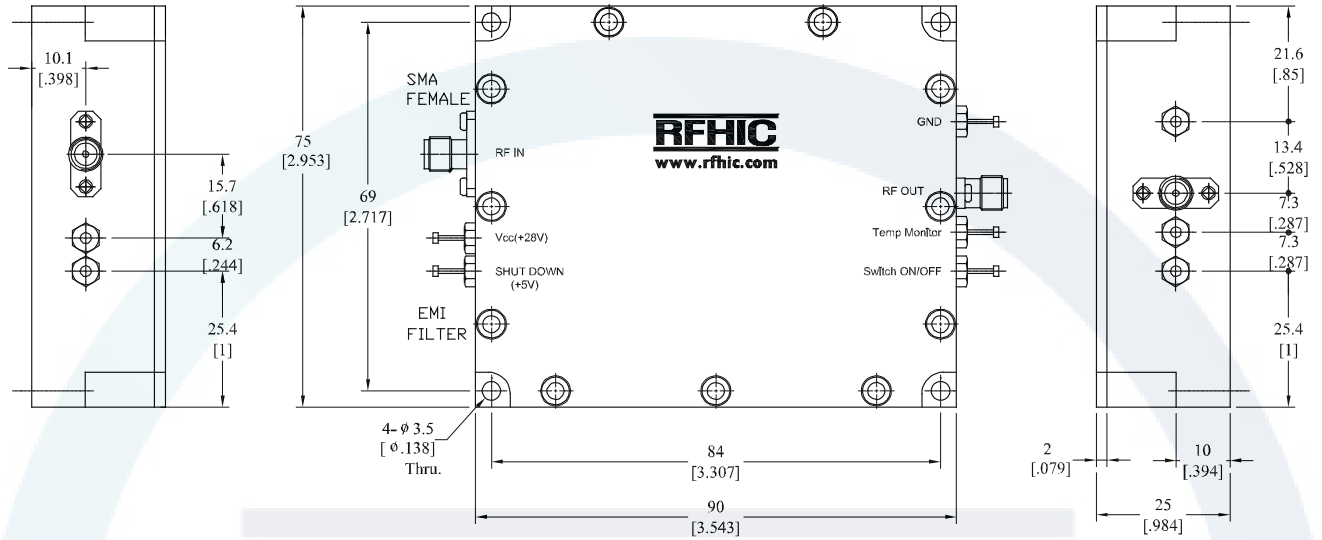

Revision History

Part Number	Release Date	Version	Modification	Data Sheet Status
RWP06040-10	2015.11.10	2.1	Note	-
RWP06040-10	2015.6.30	2.0	Electrical Specifications	-
RWP06040-10	2015.1.15	1.9	Notice Change	-



RFHIC Corporation reserves the right to make changes to any products herein or to discontinue any product at any time without notice. While product specifications have been thoroughly examined for reliability, RFHIC Corporation strongly recommends buyers to verify that the information they are using is accurate before ordering. RFHIC Corporation does not assume any liability for the suitability of its products for any particular purpose, and disclaims any and all liability, including without limitation consequential or incidental damages. RFHIC products are not intended for use in life support equipment or application where malfunction of the product can be expected to result in personal injury or death. Buyer uses or sells such products for any such unintended or unauthorized application, buyer shall indemnify, protect and hold RFHIC Corporation and its directors, officers, stockholders, employees, representatives and distributors harmless against any and all claims arising out of such unauthorized use.

Sales, inquiries and support should be directed to the local authorized geographic distributor for RFHIC Corporation. For customers in the US, please contact the US Sales Team at 919-677-8780. For all other inquiries, please contact the International Sales Team at 82-31-8069-3036.