



MiniSKiiP® 3 PIM	600V/75A				
<table border="1" style="width: 100%; border-collapse: collapse;"> <tr style="background-color: #000080; color: white;"> <th style="padding: 2px;">Features</th> </tr> <tr> <td style="padding: 2px;"> <ul style="list-style-type: none"> IGBT3 technology for low saturation losses Solderless spring contact mounting system </td> </tr> </table>	Features	<ul style="list-style-type: none"> IGBT3 technology for low saturation losses Solderless spring contact mounting system 	<table border="1" style="width: 100%; border-collapse: collapse;"> <tr style="background-color: #000080; color: white;"> <th style="padding: 2px;">MiniSkip® 3 housing</th> </tr> <tr> <td style="text-align: center; padding: 2px;">  </td> </tr> </table>	MiniSkip® 3 housing	
Features					
<ul style="list-style-type: none"> IGBT3 technology for low saturation losses Solderless spring contact mounting system 					
MiniSkip® 3 housing					
					
<table border="1" style="width: 100%; border-collapse: collapse;"> <tr style="background-color: #000080; color: white;"> <th style="padding: 2px;">Target Applications</th> </tr> <tr> <td style="padding: 2px;"> <ul style="list-style-type: none"> Industrial motor drives </td> </tr> </table>	Target Applications	<ul style="list-style-type: none"> Industrial motor drives 	<table border="1" style="width: 100%; border-collapse: collapse;"> <tr style="background-color: #000080; color: white;"> <th style="padding: 2px;">Schematic</th> </tr> <tr> <td style="text-align: center; padding: 2px;">  </td> </tr> </table>	Schematic	
Target Applications					
<ul style="list-style-type: none"> Industrial motor drives 					
Schematic					
					
<table border="1" style="width: 100%; border-collapse: collapse;"> <tr style="background-color: #000080; color: white;"> <th style="padding: 2px;">Types</th> </tr> <tr> <td style="padding: 2px;"> <ul style="list-style-type: none"> V23990-K242-A-PM </td> </tr> </table>	Types	<ul style="list-style-type: none"> V23990-K242-A-PM 			
Types					
<ul style="list-style-type: none"> V23990-K242-A-PM 					

Maximum Ratings

$T_J=25^{\circ}\text{C}$, unless otherwise specified

Parameter	Symbol	Condition	Value	Unit
D8,D9,D10,D11,D12,D13				
Repetitive peak reverse voltage	V_{RRM}		1600	V
DC forward current	I_{FAV}	$T_J=T_{Jmax}$ $T_h=80^{\circ}\text{C}$ $T_c=80^{\circ}\text{C}$	69 93	A
Surge forward current	I_{FSM}	$t_p=10\text{ms}$ $T_J=25^{\circ}\text{C}$	700	A
I ² t-value	I^2t		2450	A ² s
Power dissipation per Diode	P_{tot}	$T_J=T_{Jmax}$ $T_h=80^{\circ}\text{C}$ $T_c=80^{\circ}\text{C}$	77 117	W
Maximum Junction Temperature	T_{Jmax}		150	°C
T1,T2,T3,T4,T5,T6,T7				
Collector-emitter break down voltage	V_{CE}		600	V
DC collector current	I_C	$T_J=T_{Jmax}$ $T_h=80^{\circ}\text{C}$ $T_c=80^{\circ}\text{C}$	70 92	A
Repetitive peak collector current	I_{Cpulse}	t_p limited by T_{Jmax}	225	A
Turn off safe operating area		$V_{CE} \leq 1200\text{V}$, $T_J \leq T_{op max}$	225	A
Power dissipation per IGBT	P_{tot}	$T_J=T_{Jmax}$ $T_h=80^{\circ}\text{C}$ $T_c=80^{\circ}\text{C}$	126 191	W
Gate-emitter peak voltage	V_{GE}		±20	V
Short circuit ratings	t_{SC} V_{CC}	$T_J \leq 150^{\circ}\text{C}$ $V_{GE}=15\text{V}$	6 360	µs V
Maximum Junction Temperature	T_{Jmax}		175	°C

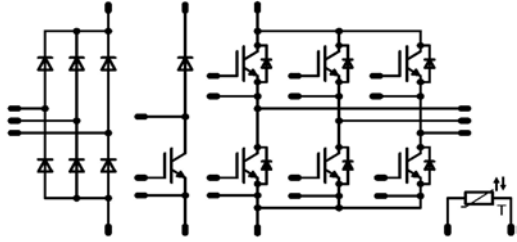
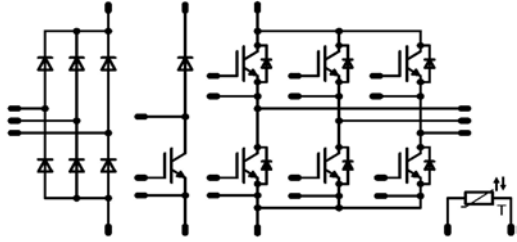
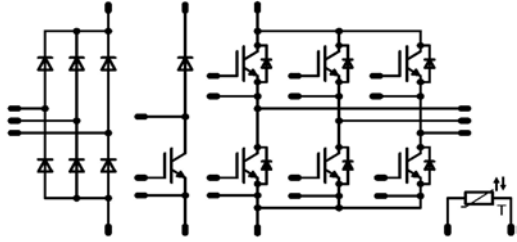
Maximum Ratings

 $T_j=25^{\circ}\text{C}$, unless otherwise specified

Parameter	Symbol	Condition	Value	Unit	
D1,D2,D3,D4,D5,D6,D7					
Peak Repetitive Reverse Voltage	V_{RRM}	$T_j=25^{\circ}\text{C}$	600	V	
DC forward current	I_F	$T_j=T_{jmax}$	$T_h=80^{\circ}\text{C}$	55	A
			$T_c=80^{\circ}\text{C}$	72	
Repetitive peak forward current	I_{FRM}	t_p limited by T_{jmax}	45	A	
Power dissipation per Diode	P_{tot}	$T_j=T_{jmax}$	$T_h=80^{\circ}\text{C}$	79	W
			$T_c=80^{\circ}\text{C}$	120	
Maximum Junction Temperature	T_{jmax}		175	$^{\circ}\text{C}$	

Thermal Properties

Storage temperature	T_{stg}		-40...+125	$^{\circ}\text{C}$
Operation temperature under switching condition	T_{op}		-40...+125	$^{\circ}\text{C}$

Insulation Properties

Insulation voltage	V_{is}	$t=2\text{s}$ DC voltage	4000	V
Creepage distance			min 12,7	mm
Clearance			min 12,7	mm

Characteristic Values

Parameter	Symbol	Conditions					Value			Unit
		$V_{GE}[V]$ or $V_{GS}[V]$	$V_f[V]$ or $V_{CE}[V]$ or $V_{DS}[V]$	$I_c[A]$ or $I_f[A]$ or $I_b[A]$	T_j	Min	Typ	Max		
D8,D9,D10,D11,D12,D13										
Forward voltage	V_F			35	$T_j=25^\circ\text{C}$ $T_j=125^\circ\text{C}$	0,8	1,02 0,94	1,35		V
Threshold voltage (for power loss calc. only)	V_{to}			35	$T_j=25^\circ\text{C}$ $T_j=125^\circ\text{C}$		0,88 0,75			V
Slope resistance (for power loss calc. only)	r_t			35	$T_j=25^\circ\text{C}$ $T_j=125^\circ\text{C}$		4 6			m Ω
Reverse current	I_r		1500		$T_j=25^\circ\text{C}$ $T_j=125^\circ\text{C}$			0,1 2		mA
Thermal resistance chip to heatsink per chip	R_{thJH}	Thermal grease thickness \leq 50um $\lambda = 1$ W/mK					0,90			K/W

T1,T2,T3,T4,T5,T6,T7

Gate emitter threshold voltage	$V_{GE(th)}$	$V_{CE}=V_{GE}$		0,0012	$T_j=25^\circ\text{C}$ $T_j=150^\circ\text{C}$	5	5,8	6,5		V
Collector-emitter saturation voltage	$V_{CE(sat)}$		15	75	$T_j=25^\circ\text{C}$ $T_j=150^\circ\text{C}$		1,54 1,75			V
Collector-emitter cut-off current incl. Diode	I_{CES}		0	612	$T_j=25^\circ\text{C}$ $T_j=150^\circ\text{C}$			0,1		mA
Gate-emitter leakage current	I_{GES}		± 25	0	$T_j=25^\circ\text{C}$ $T_j=150^\circ\text{C}$			650		nA
Integrated Gate resistor	R_{gint}						4			Ω
Turn-on delay time	$t_{d(on)}$	$R_{goff}=8 \Omega$ $R_{gon}=8 \Omega$	± 15	300	75	$T_j=25^\circ\text{C}$	217			ns
Rise time	t_r					$T_j=150^\circ\text{C}$	223			
Turn-off delay time	$t_{d(off)}$					$T_j=25^\circ\text{C}$	27			
Fall time	t_f					$T_j=150^\circ\text{C}$	30			
Turn-on energy loss per pulse	E_{on}					$T_j=25^\circ\text{C}$	266			
Turn-off energy loss per pulse	E_{off}					$T_j=150^\circ\text{C}$	290			
Input capacitance	C_{ies}	f=1MHz	0	25	$T_j=25^\circ\text{C}$		4700			pF
Output capacitance	C_{oss}						300			
Reverse transfer capacitance	C_{rss}						145			
Gate charge	Q_{Gate}		± 15		$T_j=25^\circ\text{C}$		470			nC
Thermal resistance chip to heatsink per chip	R_{thJH}	Thermal grease thickness \leq 50um $\lambda = 1$ W/mK					0,75			K/W

D1,D2,D3,D4,D5,D6,D7

Diode forward voltage	V_F			75	$T_j=25^\circ\text{C}$ $T_j=150^\circ\text{C}$	1	1,54 1,6	2,6		V
Peak reverse recovery current	I_{RRM}	$R_{goff}=8 \Omega$		300	75	$T_j=25^\circ\text{C}$	63,45			A
Reverse recovery time	t_{rr}					$T_j=150^\circ\text{C}$	74,57			
Reverse recovered charge	Q_{rr}					$T_j=25^\circ\text{C}$	58,2			
Peak rate of fall of recovery current	$di(rec)_{max}/dt$					$T_j=150^\circ\text{C}$	262,4			
Reverse recovered energy	E_{rec}					$T_j=25^\circ\text{C}$	3,74			
						$T_j=150^\circ\text{C}$	6,47			
Thermal resistance chip to heatsink per chip	R_{thJH}	Thermal grease thickness \leq 50um $\lambda = 1$ W/mK					1,2			K/W

Thermistor

Rated resistance	R				$T=25^\circ\text{C}$		1000			Ω
Deviation of R100	$\Delta R/R$	R100=1670 Ω			$T=100^\circ\text{C}$	-3		3		%
R100	P				$T=100^\circ\text{C}$		1670,313			Ω
Power dissipation constant					$T=25^\circ\text{C}$					mW/K
A-value	B(25/50)	Tol. %			$T=25^\circ\text{C}$		$7,635 \cdot 10^{-3}$			1/K
B-value	B(25/100)	Tol. %			$T=25^\circ\text{C}$		$1,731 \cdot 10^{-5}$			1/K ²
Vincotech NTC Reference									E	

T1,T2,T3,T4,T5,T6,T7 / D1,D2,D3,D4,D5,D6,D7
Figure 1 T1,T2,T3,T4,T5,T6,T7 IGBT

Typical output characteristics

$I_C = f(V_{CE})$

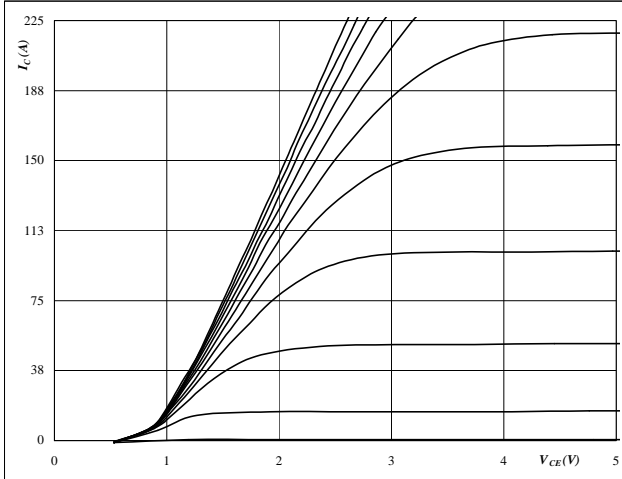

At
 $t_p = 250 \mu s$
 $T_j = 25 \text{ }^\circ C$
 V_{GE} from 7 V to 17 V in steps of 1 V

Figure 2 T1,T2,T3,T4,T5,T6,T7 IGBT

Typical output characteristics

$I_C = f(V_{CE})$

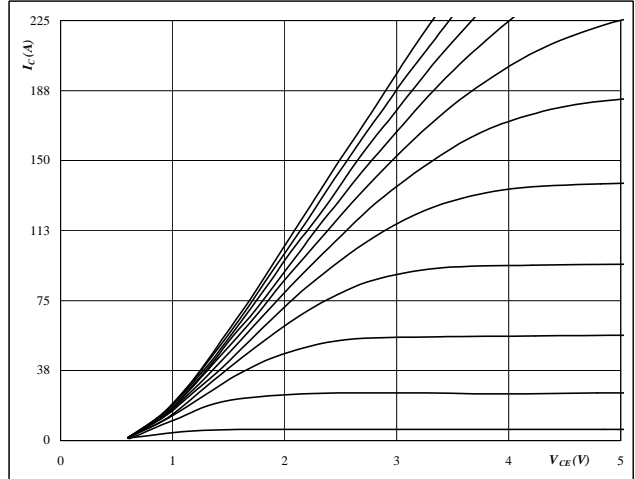

At
 $t_p = 250 \mu s$
 $T_j = 125 \text{ }^\circ C$
 V_{GE} from 7 V to 17 V in steps of 1 V

Figure 3 T1,T2,T3,T4,T5,T6,T7 IGBT

Typical transfer characteristics

$I_C = f(V_{GE})$

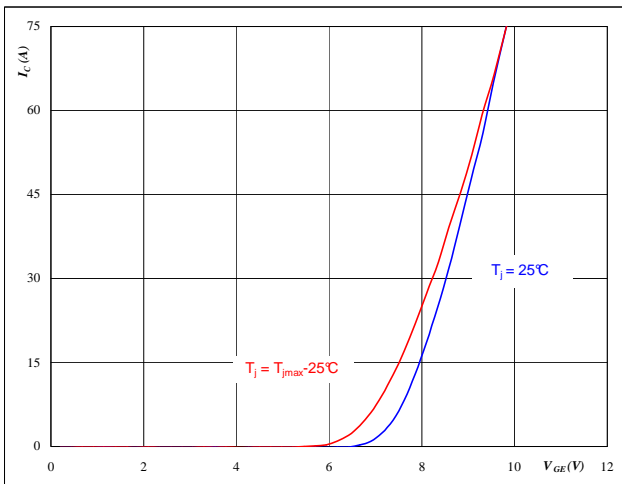

At
 $t_p = 250 \mu s$
 $V_{CE} = 10 V$

Figure 4 D1,D2,D3,D4,D5,D6,D7 FWD

Typical diode forward current as a function of forward voltage

$I_F = f(V_F)$

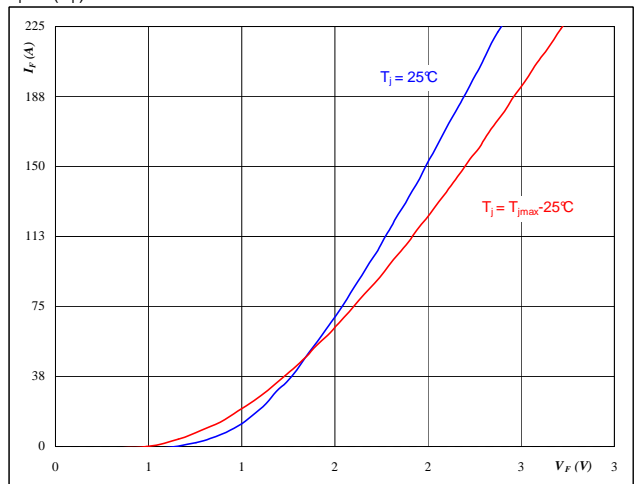

At
 $t_p = 250 \mu s$

T1,T2,T3,T4,T5,T6,T7 / D1,D2,D3,D4,D5,D6,D7
Figure 5 T1,T2,T3,T4,T5,T6,T7 IGBT

**Typical switching energy losses
as a function of collector current**

$$E = f(I_C)$$

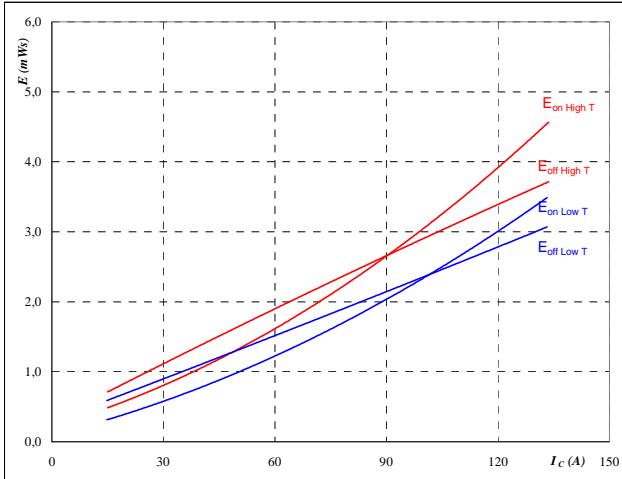

With an inductive load at

$T_J =$	25/125	°C
$V_{CE} =$	300	V
$V_{GE} =$	±15	V
$R_{gon} =$	8	Ω
$R_{goff} =$	8	Ω

Figure 6 T1,T2,T3,T4,T5,T6,T7 IGBT

**Typical switching energy losses
as a function of gate resistor**

$$E = f(R_G)$$

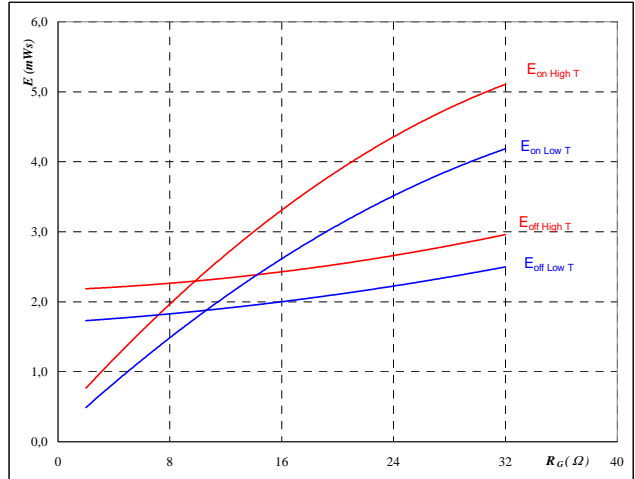

With an inductive load at

$T_J =$	25/125	°C
$V_{CE} =$	300	V
$V_{GE} =$	±15	V
$I_C =$	75	A

Figure 7 T1,T2,T3,T4,T5,T6,T7 IGBT

**Typical reverse recovery energy loss
as a function of collector current**

$$E_{rec} = f(I_C)$$

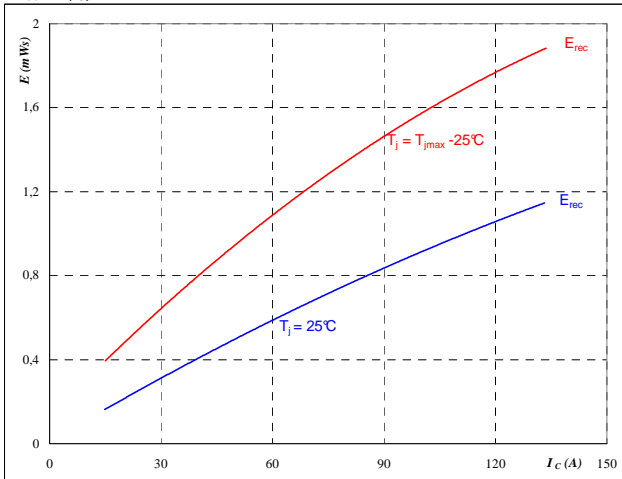

With an inductive load at

$T_J =$	25/125	°C
$V_{CE} =$	300	V
$V_{GE} =$	±15	V
$R_{gon} =$	8	Ω

Figure 8 T1,T2,T3,T4,T5,T6,T7 IGBT

**Typical reverse recovery energy loss
as a function of gate resistor**

$$E_{rec} = f(R_G)$$

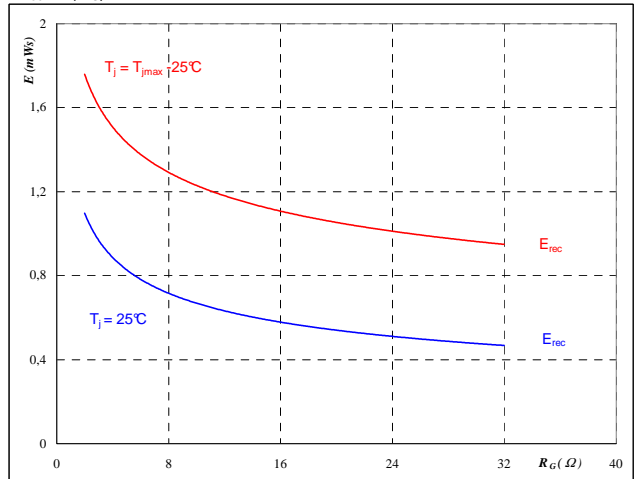

With an inductive load at

$T_J =$	25/125	°C
$V_{CE} =$	300	V
$V_{GE} =$	±15	V
$I_C =$	75	A

T1,T2,T3,T4,T5,T6,T7 / D1,D2,D3,D4,D5,D6,D7
Figure 9 T1,T2,T3,T4,T5,T6,T7 IGBT

Typical switching times as a function of collector current

$t = f(I_C)$

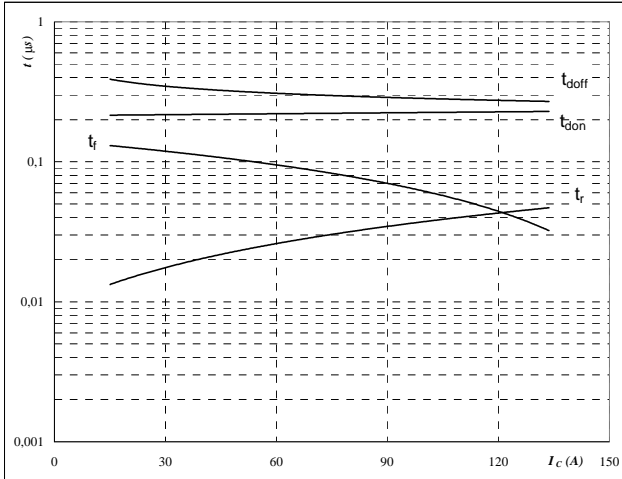

With an inductive load at

$T_j =$	125	°C
$V_{CE} =$	300	V
$V_{GE} =$	±15	V
$R_{gon} =$	8	Ω
$R_{goff} =$	8	Ω

Figure 10 T1,T2,T3,T4,T5,T6,T7 IGBT

Typical switching times as a function of gate resistor

$t = f(R_G)$

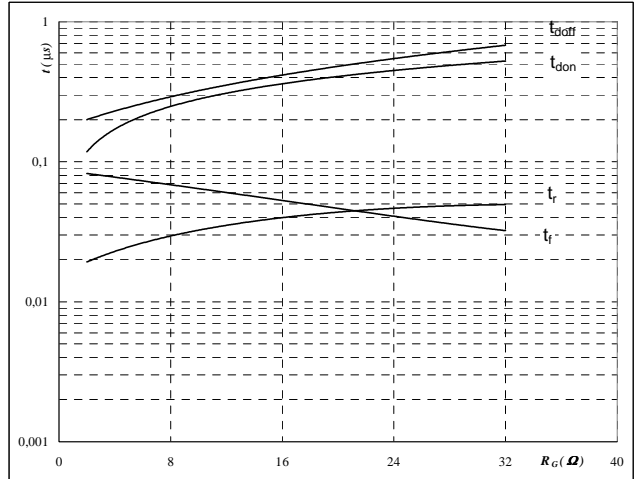

With an inductive load at

$T_j =$	125	°C
$V_{CE} =$	300	V
$V_{GE} =$	±15	V
$I_C =$	75	A

Figure 11 D1,D2,D3,D4,D5,D6,D7 FWD

Typical reverse recovery time as a function of collector current

$t_{rr} = f(I_C)$

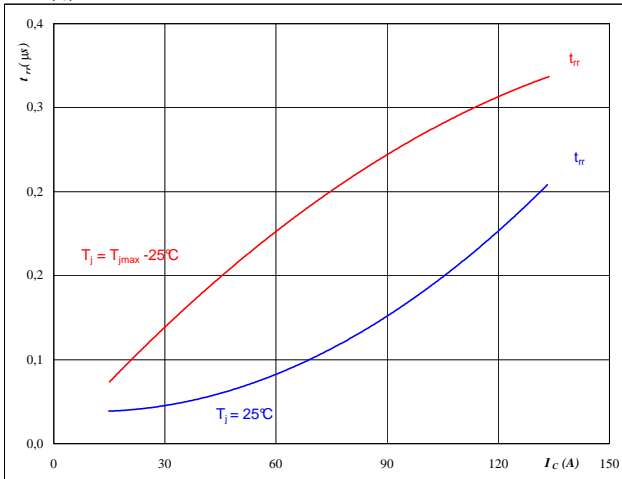

At

$T_j =$	25/125	°C
$V_{CE} =$	300	V
$V_{GE} =$	±15	V
$R_{gon} =$	8	Ω

Figure 12 D1,D2,D3,D4,D5,D6,D7 FWD

Typical reverse recovery time as a function of IGBT turn on gate resistor

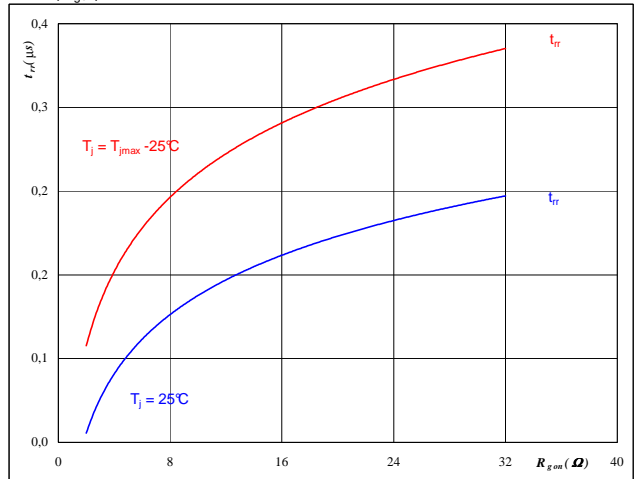
$t_{rr} = f(R_{gon})$



At

$T_j =$	25/125	°C
$V_R =$	300	V
$I_F =$	75	A
$V_{GE} =$	±15	V

T1,T2,T3,T4,T5,T6,T7 / D1,D2,D3,D4,D5,D6,D7
Figure 13 D1,D2,D3,D4,D5,D6,D7 FWD

Typical reverse recovery charge as a function of collector current

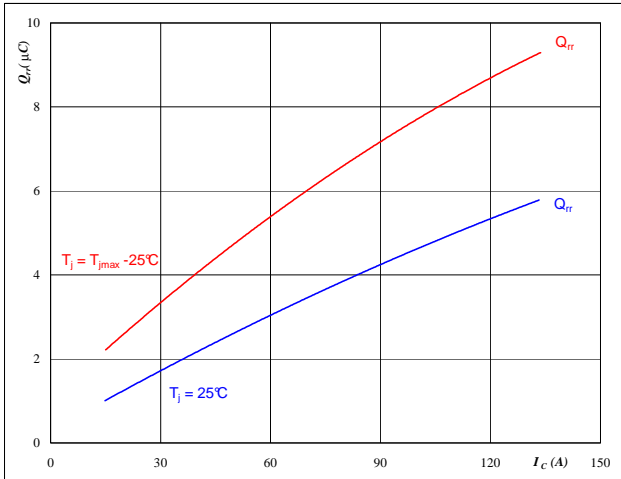
$$Q_{rr} = f(I_C)$$



At

$T_j =$	25/125	°C
$V_{CE} =$	300	V
$V_{GE} =$	±15	V
$R_{gon} =$	8	Ω

Figure 14 D1,D2,D3,D4,D5,D6,D7 FWD

Typical reverse recovery charge as a function of IGBT turn on gate resistor

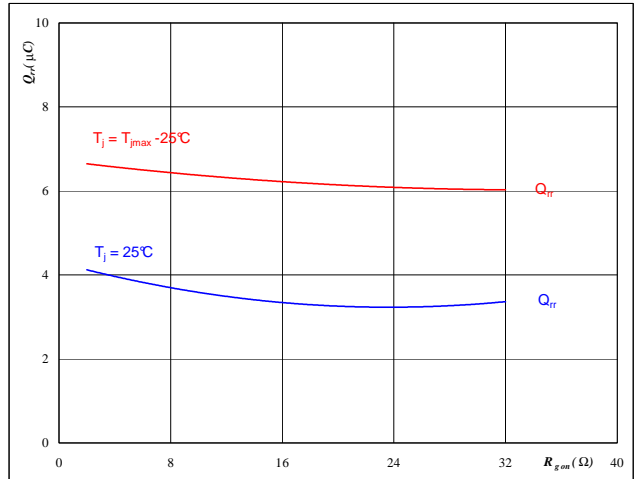
$$Q_{rr} = f(R_{gon})$$



At

$T_j =$	25/125	°C
$V_R =$	300	V
$I_F =$	75	A
$V_{GE} =$	±15	V

Figure 15 D1,D2,D3,D4,D5,D6,D7 FWD

Typical reverse recovery current as a function of collector current

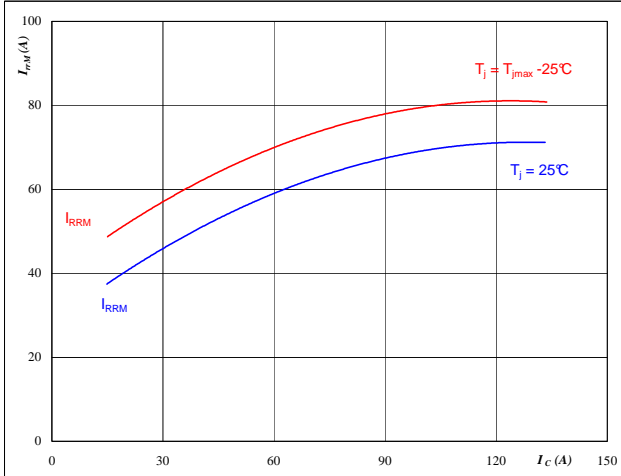
$$I_{RRM} = f(I_C)$$



At

$T_j =$	25/125	°C
$V_{CE} =$	300	V
$V_{GE} =$	±15	V
$R_{gon} =$	8	Ω

Figure 16 D1,D2,D3,D4,D5,D6,D7 FWD

Typical reverse recovery current as a function of IGBT turn on gate resistor

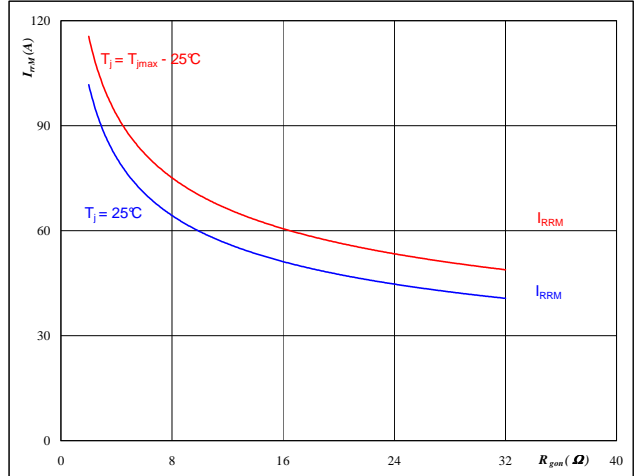
$$I_{RRM} = f(R_{gon})$$

At

$T_j =$	25/125	°C
$V_R =$	300	V
$I_F =$	75	A
$V_{GE} =$	±15	V

T1,T2,T3,T4,T5,T6,T7 / D1,D2,D3,D4,D5,D6,D7

Figure 17 D1,D2,D3,D4,D5,D6,D7 FWD

Typical rate of fall of forward and reverse recovery current as a function of collector current

$dI_f/dt, dI_{rec}/dt = f(I_C)$

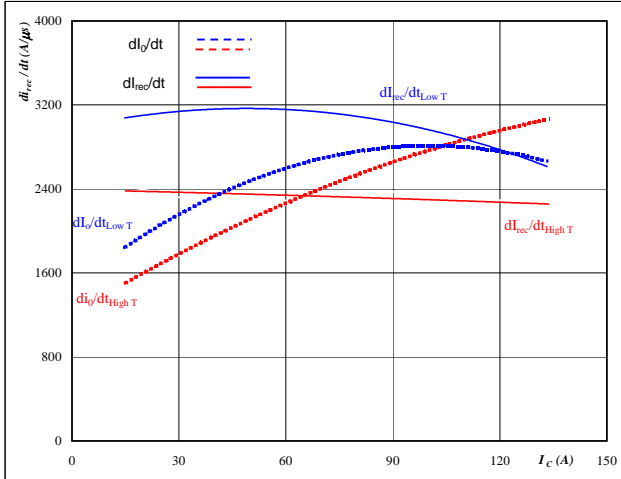

At
 $T_j = 25/125$ °C
 $V_{CE} = 300$ V
 $V_{GE} = \pm 15$ V
 $R_{gon} = 8$ Ω

Figure 18 D1,D2,D3,D4,D5,D6,D7 FWD

Typical rate of fall of forward and reverse recovery current as a function of IGBT turn on gate resistor

$dI_f/dt, dI_{rec}/dt = f(R_{gon})$

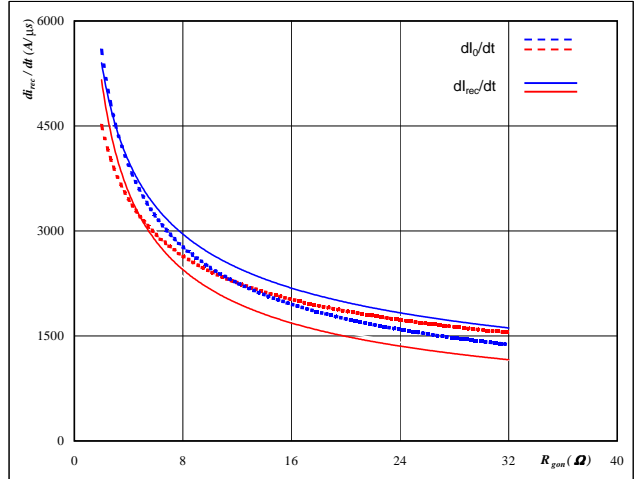

At
 $T_j = 25/125$ °C
 $V_R = 300$ V
 $I_F = 75$ A
 $V_{GE} = \pm 15$ V

Figure 19 T1,T2,T3,T4,T5,T6,T7 IGBT

IGBT transient thermal impedance as a function of pulse width

$Z_{thJH} = f(t_p)$

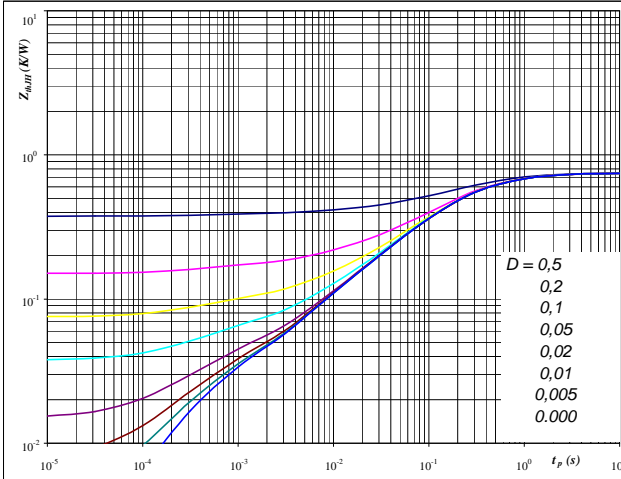

At
 $D = t_p / T$
 $R_{thJH} = 0,75$ K/W

IGBT thermal model values

Thermal grease R (C/W)	Tau (s)
0,02	9,4E+00
0,12	1,1E+00
0,41	2,1E-01
0,14	4,0E-02
0,04	6,3E-03
0,02	4,0E-04

Figure 20 D1,D2,D3,D4,D5,D6,D7 FWD

FWD transient thermal impedance as a function of pulse width

$Z_{thJH} = f(t_p)$

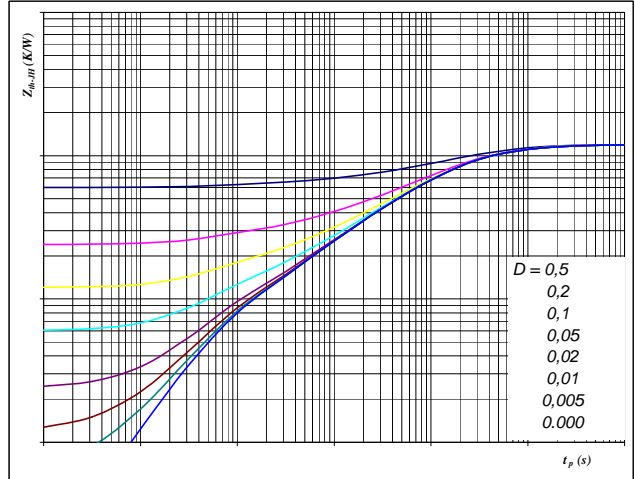

At
 $D = t_p / T$
 $R_{thJH} = 1,20$ K/W

FWD thermal model values

Thermal grease R (C/W)	Tau (s)
0,02	9,9E+00
0,19	1,0E+00
0,54	1,8E-01
0,27	3,4E-02
0,11	6,0E-03
0,07	6,5E-04

T1,T2,T3,T4,T5,T6,T7 / D1,D2,D3,D4,D5,D6,D7
Figure 21 T1,T2,T3,T4,T5,T6,T7 IGBT

Power dissipation as a function of heatsink temperature

$$P_{tot} = f(T_h)$$



At
 $T_j = 175$ °C

Figure 22 T1,T2,T3,T4,T5,T6,T7 IGBT

Collector current as a function of heatsink temperature

$$I_C = f(T_h)$$

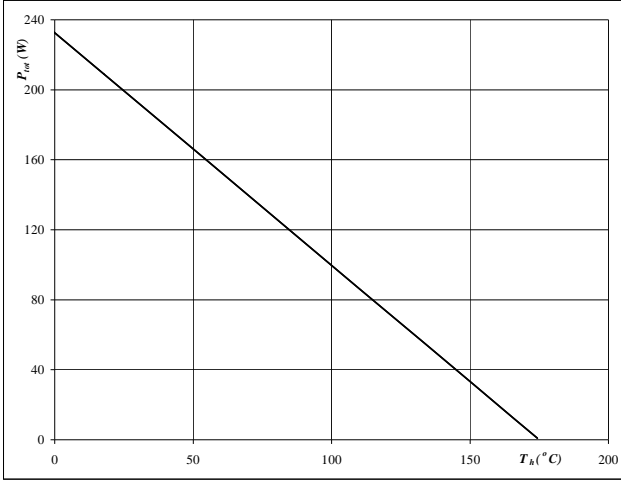

At
 $T_j = 175$ °C
 $V_{GE} = 15$ V

Figure 23 D1,D2,D3,D4,D5,D6,D7 FWD

Power dissipation as a function of heatsink temperature

$$P_{tot} = f(T_h)$$

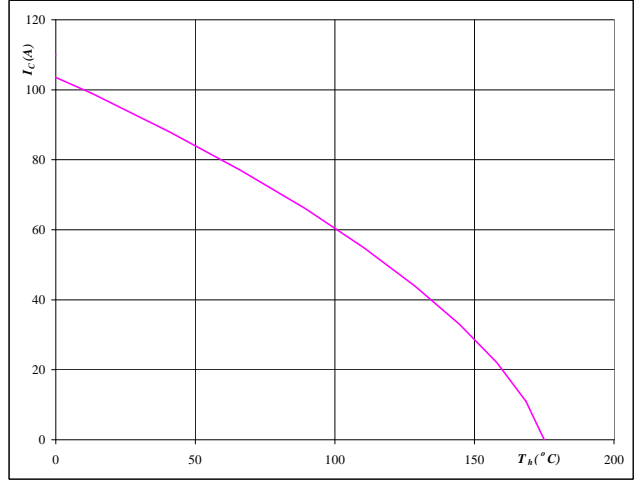

At
 $T_j = 175$ °C

Figure 24 Output inverter FWD

Forward current as a function of heatsink temperature

$$I_F = f(T_h)$$

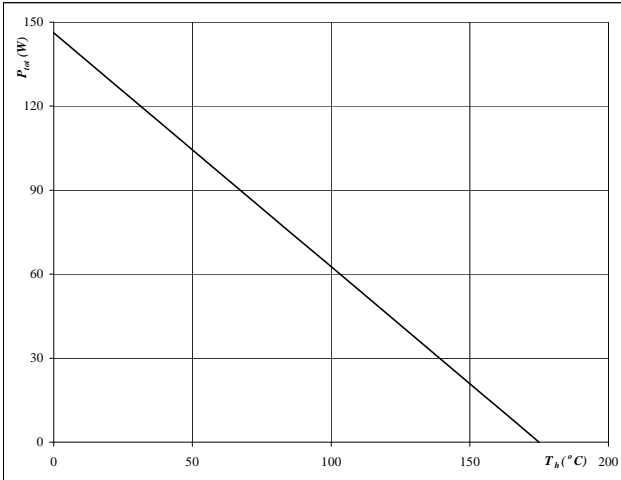
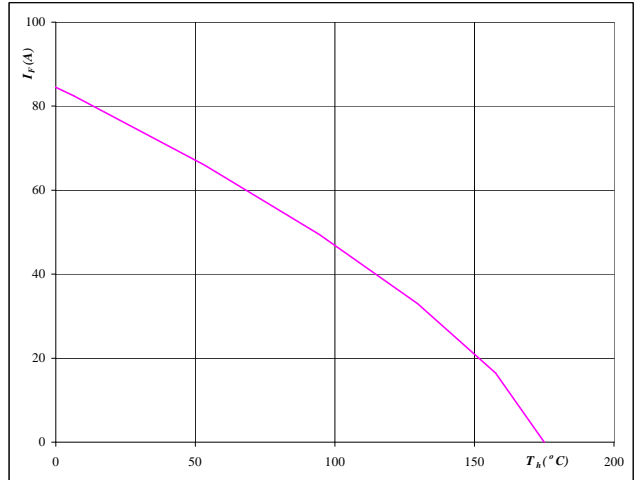
At
 $T_j = 175$ °C

T1,T2,T3,T4,T5,T6,T7 / D1,D2,D3,D4,D5,D6,D7
Figure 25 T1,T2,T3,T4,T5,T6,T7 IGBT

Safe operating area as a function of collector-emitter voltage

$I_C = f(V_{CE})$

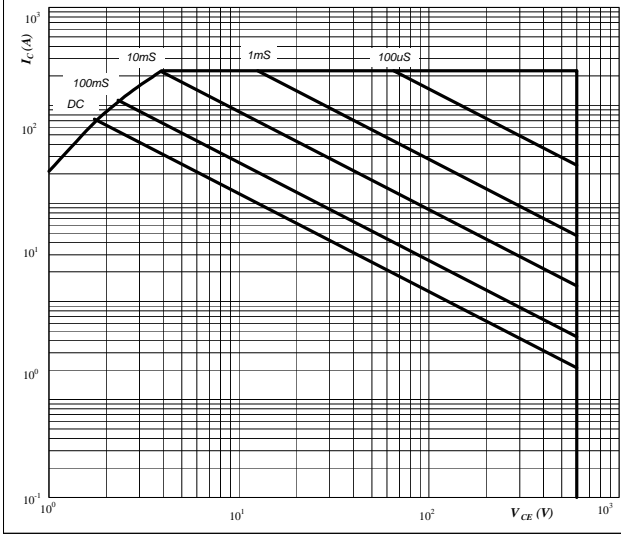

At
 D = single pulse
 T_h = 80 °C
 V_{GE} = ±15 V
 T_j = T_{jmax} °C

Figure 26 T1,T2,T3,T4,T5,T6,T7 IGBT

Gate voltage vs Gate charge

$V_{GE} = f(Q_{GE})$

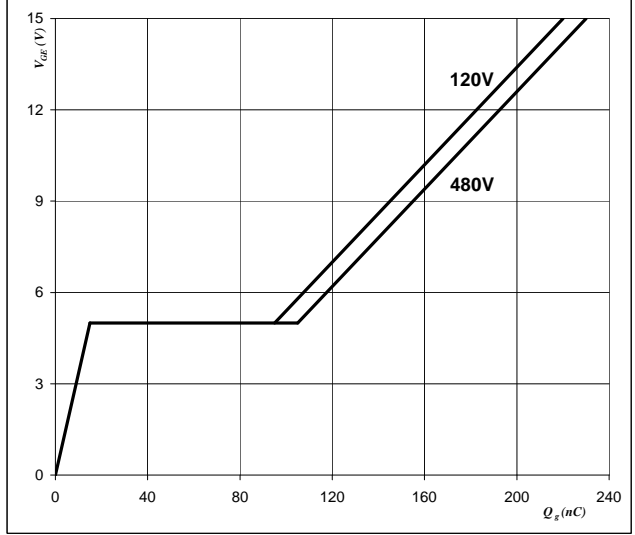

At
 I_C = 75 A

D8,D9,D10,D11,D12,D13
Figure 1 D8,D9,D10,D11,D12,D13 diode

Typical diode forward current as a function of forward voltage

$$I_F = f(V_F)$$

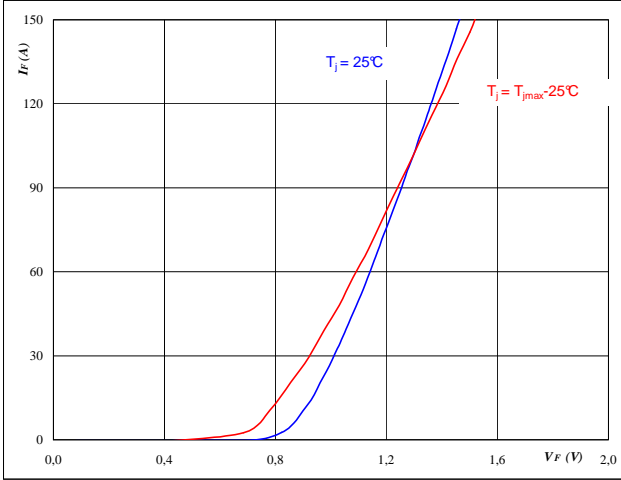
At
 $t_p = 250 \mu s$
Figure 2 D8,D9,D10,D11,D12,D13 diode

Diode transient thermal impedance as a function of pulse width

$$Z_{thJH} = f(t_p)$$

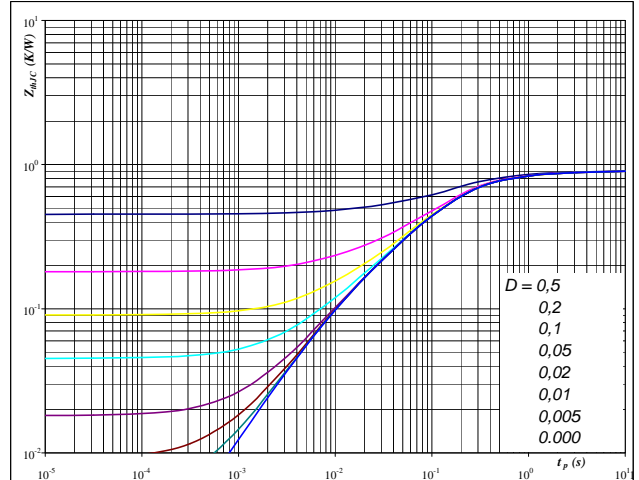
At
 $D = t_p / T$
 $R_{thJH} = 0,90 \text{ K/W}$
Figure 3 D8,D9,D10,D11,D12,D13 diode

Power dissipation as a function of heatsink temperature

$$P_{tot} = f(T_h)$$

At
 $T_j = 150 \text{ °C}$
Figure 4 D8,D9,D10,D11,D12,D13 diode

Forward current as a function of heatsink temperature

$$I_F = f(T_h)$$

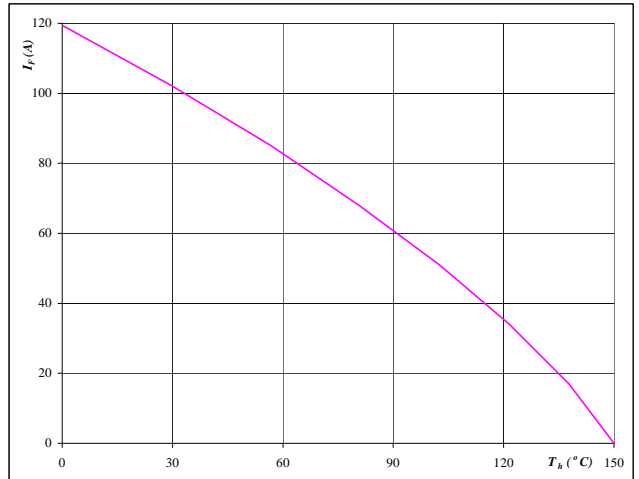

At
 $T_j = 150 \text{ °C}$

Thermistor

Figure 1 Thermistor

Typical PTC characteristic
as a function of temperature

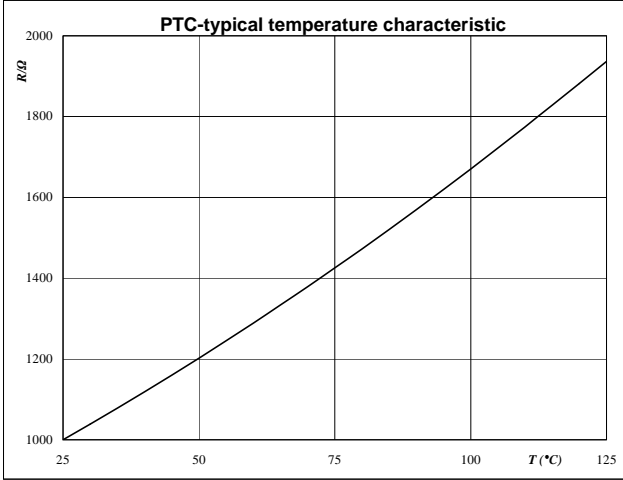
$$R_T = f(T)$$



Switching Definitions Output Inverter

General conditions	
T_j	= 125 °C
R_{gon}	= 8 Ω
R_{goff}	= 8 Ω

Figure 1 Output inverter IGBT

Turn-off Switching Waveforms & definition of t_{doff} , t_{Eoff}
 (t_{Eoff} = integrating time for E_{off})

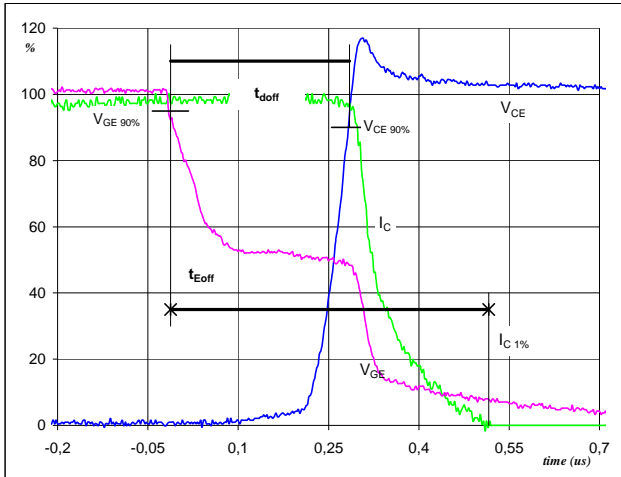

$V_{GE}(0\%) =$	-15	V
$V_{GE}(100\%) =$	15	V
$V_C(100\%) =$	300	V
$I_C(100\%) =$	75	A
$t_{doff} =$	0,29	μs
$t_{Eoff} =$	0,53	μs

Figure 2 Output inverter IGBT

Turn-on Switching Waveforms & definition of t_{don} , t_{Eon}
 (t_{Eon} = integrating time for E_{on})

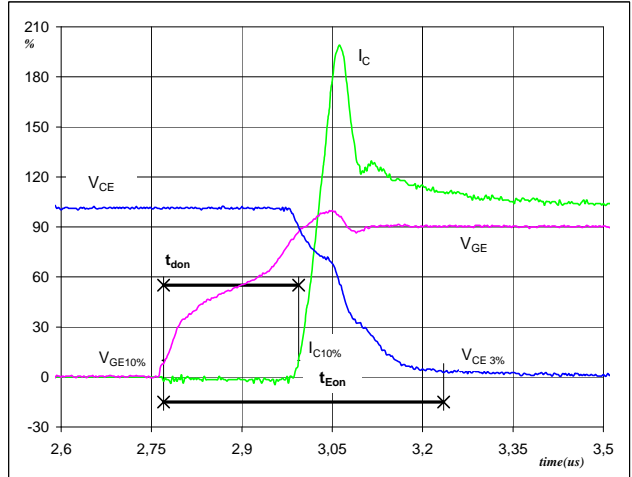

$V_{GE}(0\%) =$	-15	V
$V_{GE}(100\%) =$	15	V
$V_C(100\%) =$	300	V
$I_C(100\%) =$	75	A
$t_{don} =$	0,22	μs
$t_{Eon} =$	0,47	μs

Figure 3 Output inverter IGBT

Turn-off Switching Waveforms & definition of t_f

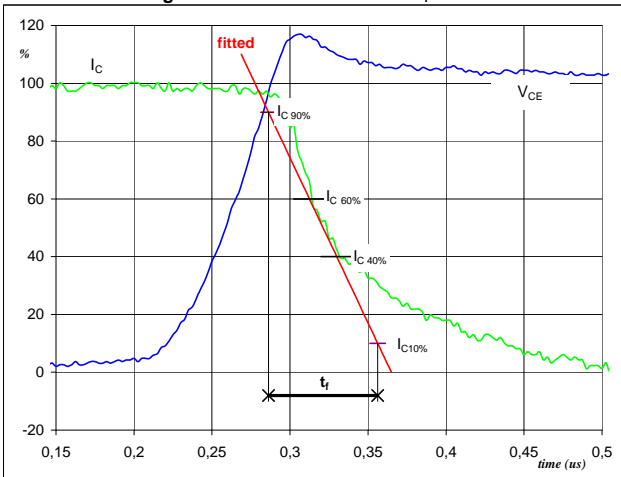

$V_C(100\%) =$	300	V
$I_C(100\%) =$	75	A
$t_f =$	0,08	μs

Figure 4 Output inverter IGBT

Turn-on Switching Waveforms & definition of t_r

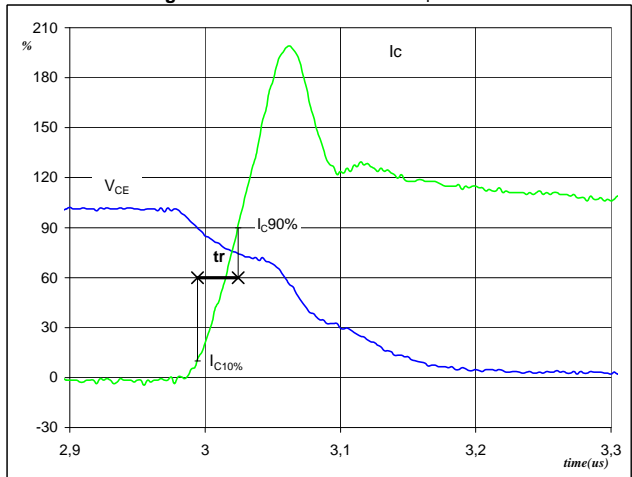

$V_C(100\%) =$	300	V
$I_C(100\%) =$	75	A
$t_r =$	0,03	μs

Switching Definitions Output Inverter

Figure 5 Output inverter IGBT

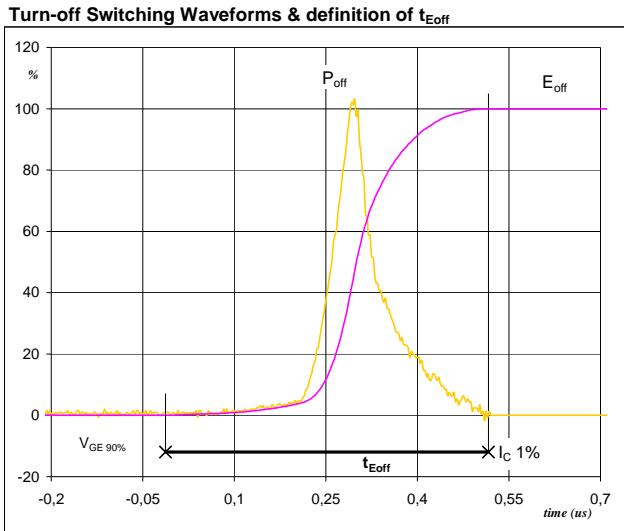

$P_{off} (100\%) = 22,50 \text{ kW}$
 $E_{off} (100\%) = 2,24 \text{ mJ}$
 $t_{Eoff} = 0,53 \text{ } \mu\text{s}$

Figure 6 Output inverter IGBT

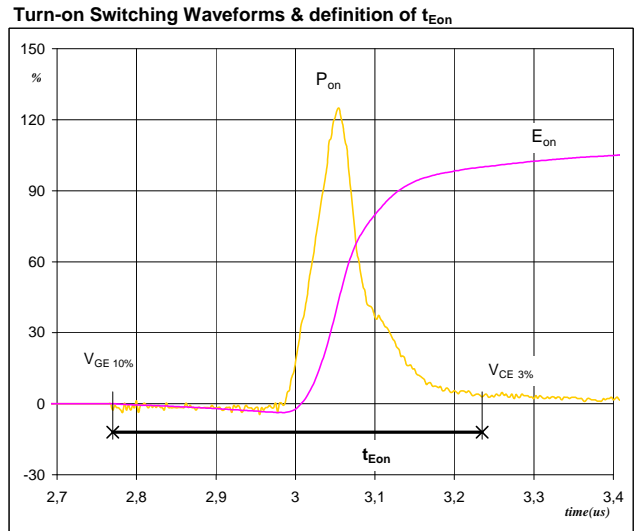

$P_{on} (100\%) = 22,50 \text{ kW}$
 $E_{on} (100\%) = 2,07 \text{ mJ}$
 $t_{Eon} = 0,47 \text{ } \mu\text{s}$

Figure 7 Output inverter FWD

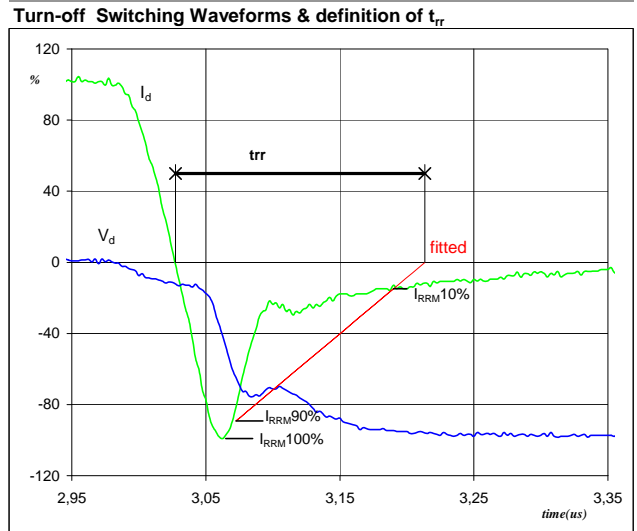

$V_d (100\%) = 300 \text{ V}$
 $I_d (100\%) = 75 \text{ A}$
 $I_{RRM} (100\%) = 75 \text{ A}$
 $t_{rr} = 0,26 \text{ } \mu\text{s}$

Switching Definitions Output Inverter

Figure 8 Output inverter FWD

Turn-on Switching Waveforms & definition of t_{Qrr}
 (t_{Qrr} = integrating time for Q_{rr})

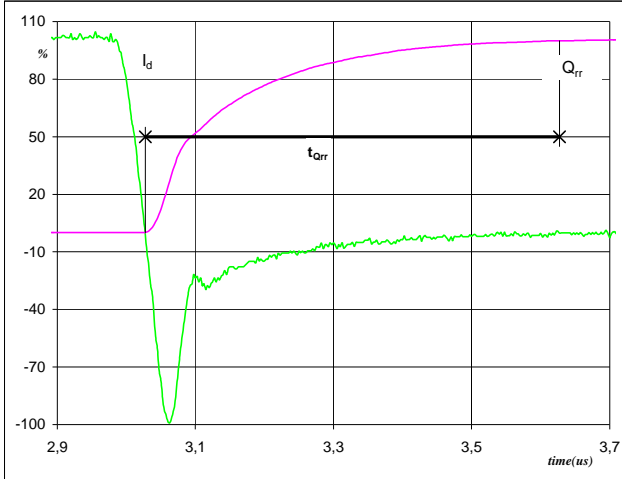

I_d (100%) =	75	A
Q_{rr} (100%) =	6,47	μC
t_{Qrr} =	0,60	μs

Figure 9 Output inverter FWD

Turn-on Switching Waveforms & definition of t_{Erec}
 (t_{Erec} = integrating time for E_{rec})

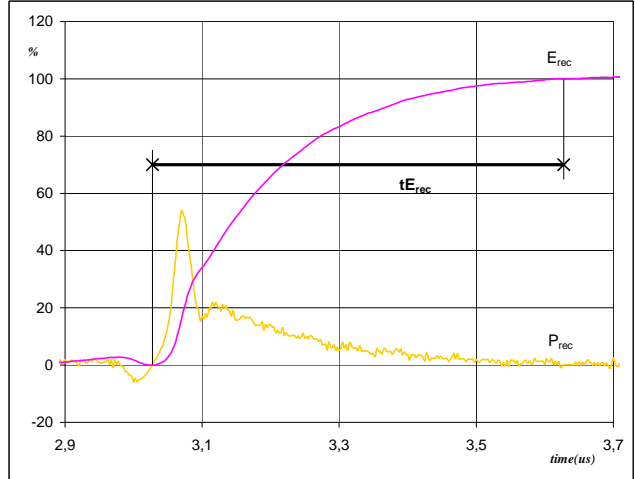

P_{rec} (100%) =	22,50	kW
E_{rec} (100%) =	1,33	mJ
t_{Erec} =	0,60	μs

Ordering Code and Marking - Outline - Pinout

Ordering Code & Marking

Version	Ordering Code	in DataMatrix as	in packaging barcode as
with std lid (black V23990-K32-T-PM)	V23990-K242-A-/0A/-PM	K242A	K242A-/0A/
with std lid (black V23990-K32-T-PM) and P12	V23990-K242-A-/1A/-PM	K242A	K242A-/1A/
with thin lid (white V23990-K33-T-PM)	V23990-K242-A-/0B/-PM	K242A	K242A-/0B/
with thin lid (white V23990-K33-T-PM) and P12	V23990-K242-A-/1B/-PM	K242A	K242A-/1B/

Outline

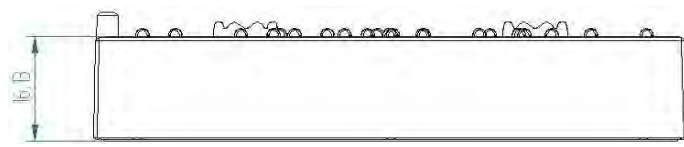
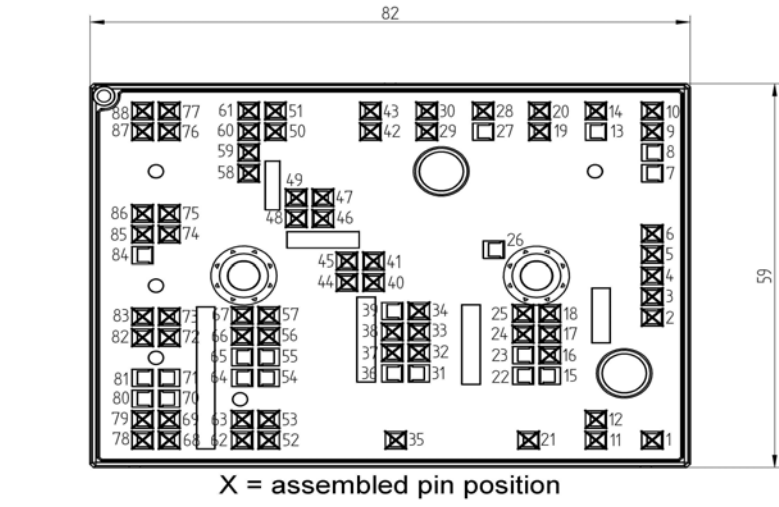

Pinout

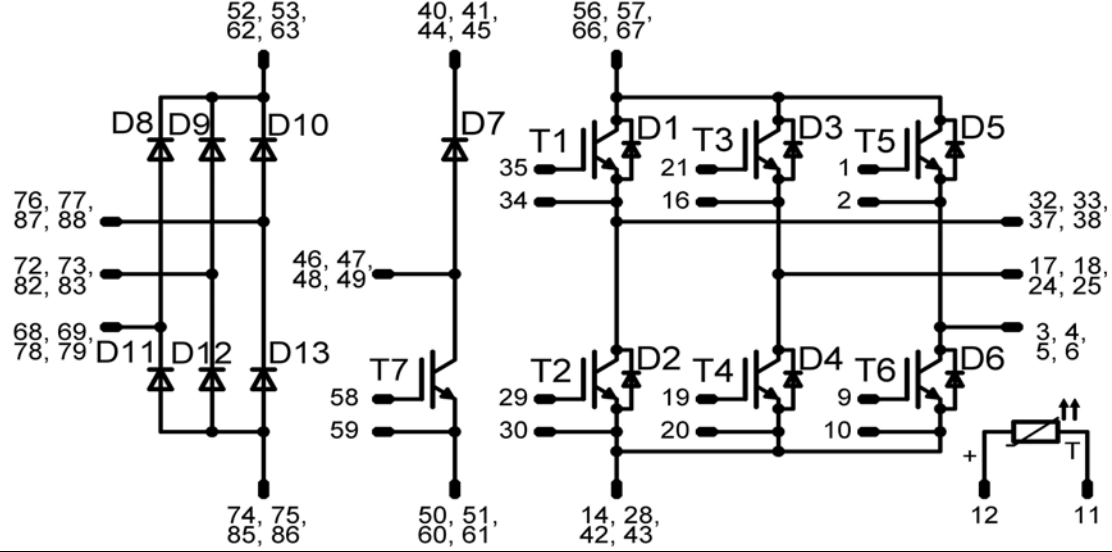

DISCLAIMER

The information given in this datasheet describes the type of component and does not represent assured characteristics. For tested values please contact Vincotech. Vincotech reserves the right to make changes without further notice to any products herein to improve reliability, function or design. Vincotech does not assume any liability arising out of the application or use of any product or circuit described herein; neither does it convey any license under its patent rights, nor the rights of others.

LIFE SUPPORT POLICY

Vincotech products are not authorised for use as critical components in life support devices or systems without the express written approval of Vincotech.

As used herein:

1. Life support devices or systems are devices or systems which, (a) are intended for surgical implant into the body, or (b) support or sustain life, or (c) whose failure to perform when properly used in accordance with instructions for use provided in labelling can be reasonably expected to result in significant injury to the user.
2. A critical component is any component of a life support device or system whose failure to perform can be reasonably expected to cause the failure of the life support device or system, or to affect its safety or effectiveness.