



S-19254xxxH Series

FOR AUTOMOTIVE 105°C OPERATION LOW DROPOUT HIGH OUTPUT CURRENT CMOS VOLTAGE REGULATOR WITH SOFT-START FUNCTION

www.sii-ic.com

© SII Semiconductor Corporation, 2016

Rev.1.1_00

The S-19254xxxH Series developed by using high-withstand voltage CMOS process technology, is a positive voltage regulator with high-accuracy output voltage and high output current.

A built-in overcurrent protection circuit to limit overcurrent of the output transistor and a built-in thermal shutdown circuit to limit heat are included. Also, the S-19254xxxH Series includes the soft-start function to adjust the output voltage rising time at power-on or at the time when the ON / OFF pin is set to ON.

Caution This product can be used in vehicle equipment and in-vehicle equipment. Before using the product in the purpose, contact to SII Semiconductor Corporation is indispensable.

■ Features

- Output voltage: 1.0 V to 5.5 V, selectable in 0.05 V step
- Input voltage: 2.5 V to 6.5 V
- Output voltage accuracy: $\pm 3.0\%$ ($T_j = -40^\circ\text{C}$ to $+105^\circ\text{C}$)
- Dropout voltage: 0.38 V typ. (2.6 V output product, at $I_{OUT} = 1000$ mA)
- Current consumption: During operation: 120 μA typ., 150 μA max. ($T_j = -40^\circ\text{C}$ to $+105^\circ\text{C}$)
During power-off: 0.1 μA typ., 4.5 μA max. ($T_j = -40^\circ\text{C}$ to $+105^\circ\text{C}$)
- Output current: Possible to output 1000 mA (at $V_{IN} \geq V_{OUT(S)} + 1.0$ V)^{*1}
- Ripple rejection: 60 dB typ. (at $f = 1.0$ kHz)
- Built-in overcurrent protection circuit: Limits overcurrent of output transistor.
- Built-in thermal shutdown circuit: Detection temperature 170°C typ.
- Built-in soft-start circuit: Adjusts output voltage rising time at power-on or at the time when ON / OFF pin is set to ON.
Adjustable type: $t_{SS} = 6.0$ ms typ. ($C_{SS} = 10$ nF)
Soft-start time can be changed by the capacitor (C_{SS}).
- Built-in ON / OFF circuit: Ensures long battery life.
- Built-in discharge shunt circuit: Discharges the electric charge of the output capacitor during power-off.
- Operation temperature range: $T_a = -40^\circ\text{C}$ to $+105^\circ\text{C}$
- Lead-free (Sn 100%), halogen-free
- AEC-Q100 qualified^{*2}

*1. Please make sure that the loss of the IC will not exceed the power dissipation when the output current is large.

*2. Contact our sales office for details.

■ Applications

- Constant-voltage power supply for electrical application for vehicle interior
- Constant-voltage power supply for home electric appliance
- For automotive use (accessory, car navigation system, car audio system, etc.)

■ Package

- HSOP-8A

■ **Block Diagram**

ON / OFF logic	: Active "H"	Discharge shunt function	: Available
Pull-down resistor	: Available	Soft-start time	: Changeable by capacitor (C _{SS})

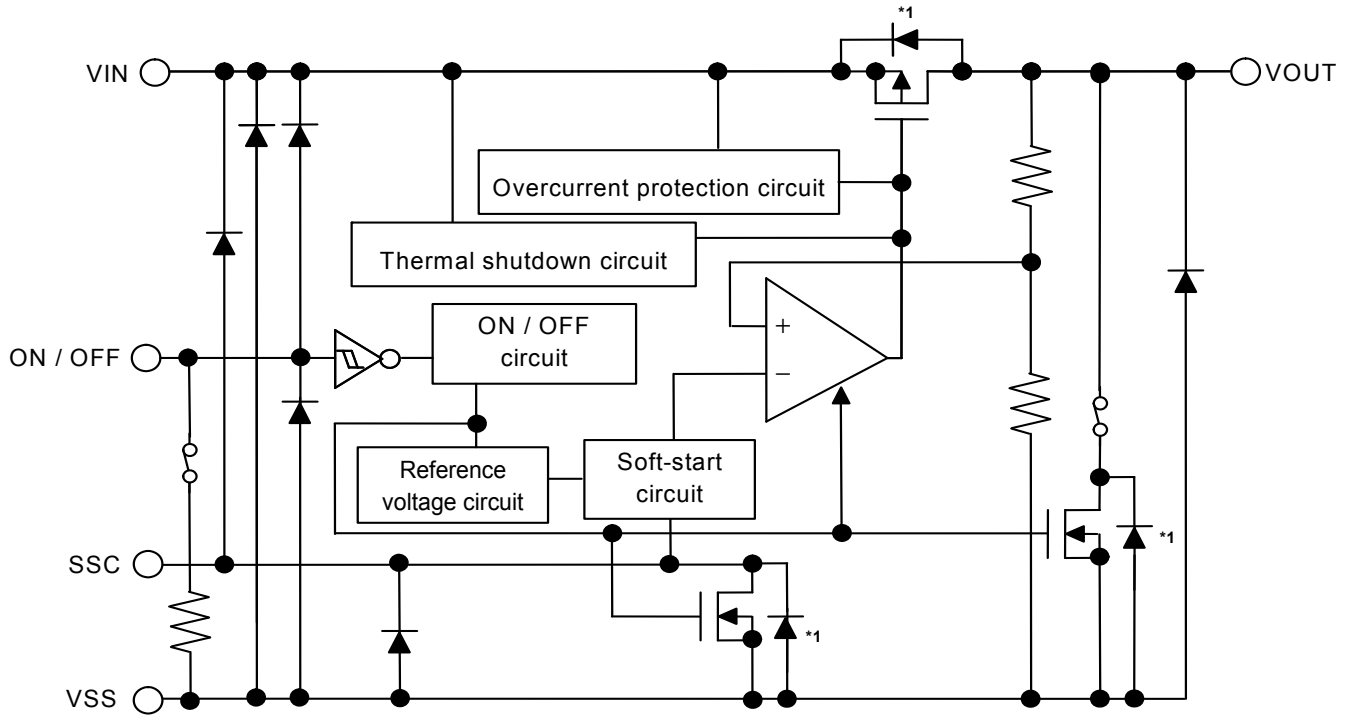

*1. Parasitic diode

Figure 1

■ AEC-Q100 Qualified

This IC supports AEC-Q100 for operation temperature grade 2.
 Contact our sales office for details of AEC-Q100 reliability specification.

■ Product Name Structure

Users can select the output voltage for the S-19254xxxH Series. Refer to "1. Product name" regarding the contents of product name, "2. Package" regarding the package drawings and "3. Product name list" for details of product names.

1. Product name

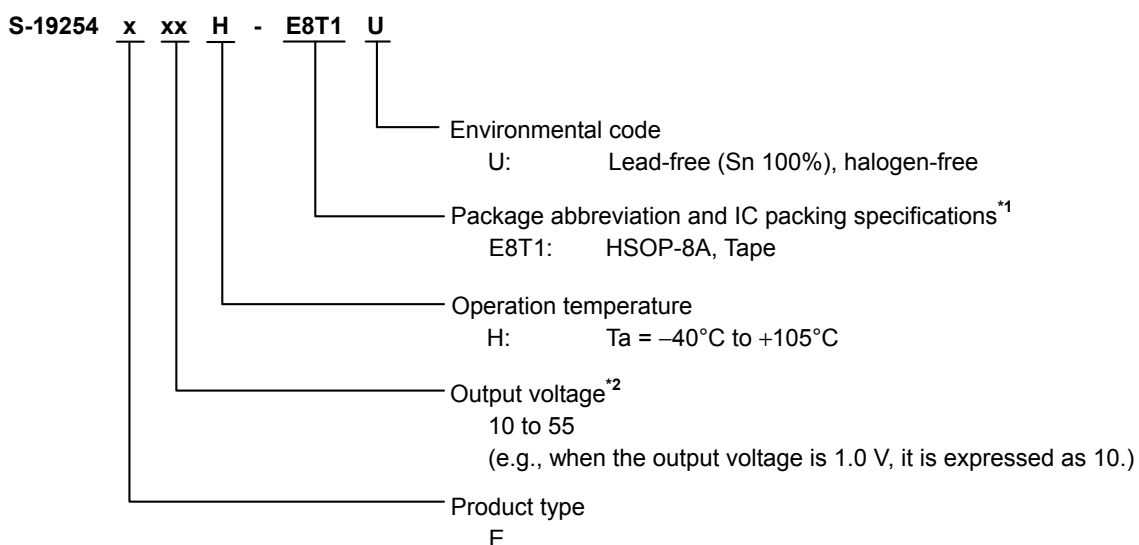

*1. Refer to the tape drawing.

*2. Contact our sales office when the product which has 0.05 V step is necessary.

2. Package

Table 1 Package Drawing Codes

Package Name	Dimension	Tape	Reel	Land
HSOP-8A	FH008-A-P-SD	FH008-A-C-SD	FH008-A-R-SD	FH008-A-L-SD

4. Product name list

Table 2

Output Voltage	HSOP-8A
1.2 V ± 3.0%	S-19254E12H-E8T1U
1.8 V ± 3.0%	S-19254E18H-E8T1U
3.3 V ± 3.0%	S-19254E33H-E8T1U
5.0 V ± 3.0%	S-19254E50H-E8T1U

Remark Please contact our sales office for products with specifications other than the above output voltage.

■ Pin Configuration

1. HSOP-8A

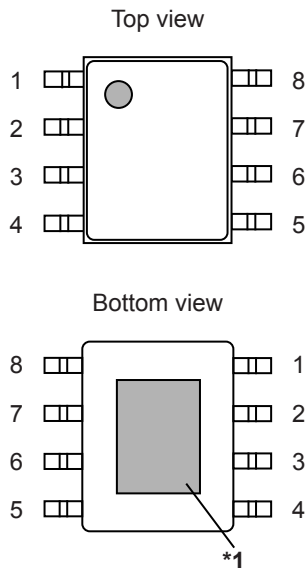

Figure 2

Table 3

Pin No.	Symbol	Description
1	VOUT	Output voltage pin
2	NC ^{*2}	No connection
3	VSS	GND pin
4	ON / OFF	ON / OFF pin
5	SSC ^{*3}	Soft-start pin
6	NC ^{*2}	No connection
7	NC ^{*2}	No connection
8	VIN	Input voltage pin

- *1. Connect the heat sink of backside at shadowed area to the board, and set electric potential open or GND. However, do not use it as the function of electrode.
- *2. The NC pin is electrically open.
The NC pin can be connected to the VIN pin or the VSS pin.
- *3. Connect a capacitor between the SSC pin and the VSS pin.
The soft-start time at power-on and at the time when the ON / OFF pin is set to ON can be adjusted according to the capacitance.

■ **Absolute Maximum Ratings**

Table 4

(Ta = +25°C unless otherwise specified)

Item	Symbol	Absolute Maximum Rating	Unit
Input voltage	V _{IN}	V _{SS} – 0.3 to V _{SS} + 7	V
	V _{ON / OFF}	V _{SS} – 0.3 to V _{IN} + 0.3 ≤ V _{SS} + 7	V
	V _{SSC}	V _{SS} – 0.3 to V _{IN} + 0.3 ≤ V _{SS} + 7	V
Output voltage	V _{OUT}	V _{SS} – 0.3 to V _{IN} + 0.3 ≤ V _{SS} + 7	V
Output current	I _{OUT}	1100	mA
Junction temperature	T _j	–40 to +150	°C
Operation ambient temperature	T _{opr}	–40 to +105	°C
Storage temperature	T _{stg}	–40 to +150	°C

Caution The absolute maximum ratings are rated values exceeding which the product could suffer physical damage. These values must therefore not be exceeded under any conditions.

■ **Thermal Resistance Value**

Table 5

Item	Symbol	Condition	Min.	Typ.	Max.	Unit	
Junction-to-ambient thermal resistance*1	θ _{ja}	HSOP-8A	Board A	–	104	–	°C/W
			Board B	–	74	–	°C/W
			Board C	–	39	–	°C/W
			Board D	–	37	–	°C/W
			Board E	–	31	–	°C/W

*1. Test environment: compliance with JEDEC STANDARD JESD51-2A

Remark Refer to "■ Power Dissipation" and "Test Board" for details.

■ Electrical Characteristics

Table 6 (1 / 2)

(T_j = -40°C to +105°C unless otherwise specified)

Item	Symbol	Condition	Min.	Typ.	Max.	Unit	Test Circuit	
Output voltage *1	V _{OUT(E)}	V _{IN} = 2.5 V, I _{OUT} = 100 mA	V _{OUT(S)} < 1.5 V	V _{OUT(S)} × 0.970	V _{OUT(S)}	V _{OUT(S)} × 1.030	V	1
		V _{IN} = V _{OUT(S)} + 1.0 V, I _{OUT} = 100 mA	1.5 V ≤ V _{OUT(S)}	V _{OUT(S)} × 0.970	V _{OUT(S)}	V _{OUT(S)} × 1.030	V	1
Output current *2	I _{OUT}	V _{IN} = 2.5 V	V _{OUT(S)} < 1.5 V	1000*5	–	–	mA	3
		V _{IN} ≥ V _{OUT(S)} + 1.0 V	1.5 V ≤ V _{OUT(S)}	1000*5	–	–	mA	3
Dropout voltage *3	V _{drop}	I _{OUT} = 300 mA, Ta = +25°C	1.0 V ≤ V _{OUT(S)} < 2.0 V	–	*4	–	V	1
			2.0 V ≤ V _{OUT(S)} < 2.6 V	–	0.52	–	V	1
			2.6 V ≤ V _{OUT(S)} ≤ 5.5 V	–	0.11	–	V	1
		I _{OUT} = 1000 mA, Ta = +25°C	1.0 V ≤ V _{OUT(S)} < 2.0 V	–	*4	–	V	1
			2.0 V ≤ V _{OUT(S)} < 2.6 V	–	0.54	–	V	1
			2.6 V ≤ V _{OUT(S)} ≤ 5.5 V	–	0.38	–	V	1
Line regulation	$\frac{\Delta V_{OUT1}}{\Delta V_{IN} \cdot V_{OUT}}$	2.5 V ≤ V _{IN} ≤ 6.5 V, I _{OUT} = 100 mA, Ta = +25°C	V _{OUT(S)} < 2.0 V	–	0.05	0.2	%/V	1
		V _{OUT(S)} + 0.5 V ≤ V _{IN} ≤ 6.5 V, I _{OUT} = 100 mA, Ta = +25°C	2.0 V ≤ V _{OUT(S)}	–	0.05	0.2	%/V	1
Load regulation	ΔV _{OUT2}	V _{IN} = 2.5 V, 1 mA ≤ I _{OUT} ≤ 300 mA, Ta = +25°C	V _{OUT(S)} < 1.5 V	–	15	30	mV	1
		V _{IN} = V _{OUT(S)} + 1.0 V, 1 mA ≤ I _{OUT} ≤ 300 mA, Ta = +25°C	1.5 V ≤ V _{OUT(S)}	–	15	30	mV	1
Current consumption during operation	I _{SS1}	V _{IN} = 2.5 V, ON / OFF pin = ON, no load	V _{OUT(S)} < 1.5 V	–	120	150	μA	2
		V _{IN} = V _{OUT(S)} + 1.0 V, ON / OFF pin = ON, no load	1.5 V ≤ V _{OUT(S)}	–	120	150	μA	2
Current consumption during power-off	I _{SS2}	V _{IN} = 2.5 V, ON / OFF pin = OFF, no load	V _{OUT(S)} < 1.5 V	–	0.1	4.5	μA	2
		V _{IN} = V _{OUT(S)} + 1.0 V, ON / OFF pin = OFF, no load	1.5 V ≤ V _{OUT(S)}	–	0.1	4.5	μA	2
Input voltage	V _{IN}	–	2.5	–	6.5	V	–	

Table 6 (2 / 2)

(T_j = -40°C to +105°C unless otherwise specified)

Item	Symbol	Condition	Min.	Typ.	Max.	Unit	Test Circuit	
ON / OFF pin input voltage "H"	V _{SH}	V _{IN} = 2.5 V, R _L = 1 kΩ, determined by V _{OUT} output level V _{OUT(S)} < 1.5 V	2.1	–	–	V	4	
		V _{IN} = V _{OUT(S)} + 1.0 V, R _L = 1 kΩ, determined by V _{OUT} output level 1.5 V ≤ V _{OUT(S)}	2.1	–	–	V	4	
ON / OFF pin input voltage "L"	V _{SL}	V _{IN} = 2.5 V, R _L = 1 kΩ, determined by V _{OUT} output level V _{OUT(S)} < 1.5 V	–	–	0.6	V	4	
		V _{IN} = V _{OUT(S)} + 1.0 V, R _L = 1 kΩ, determined by V _{OUT} output level 1.5 V ≤ V _{OUT(S)}	–	–	0.6	V	4	
ON / OFF pin input current "H"	I _{SH}	V _{IN} = 6.5 V, V _{ON / OFF} = 6.5 V	0.8	2.5	7.8	μA	4	
ON / OFF pin input current "L"	I _{SL}	V _{IN} = 6.5 V, V _{ON / OFF} = 0 V	-0.1	–	0.1	μA	4	
Ripple rejection	RR	V _{IN} = 3.0 V, f = 1 kHz, ΔV _{rip} = 0.5 Vrms, I _{OUT} = 100 mA	1.0 V ≤ V _{OUT(S)} < 1.5 V	–	60	–	dB	5
			1.5 V ≤ V _{OUT(S)} < 2.0 V	–	55	–	dB	5
		V _{IN} = V _{OUT(S)} + 1.0 V, f = 1 kHz, ΔV _{rip} = 0.5 Vrms, I _{OUT} = 100 mA	2.0 V ≤ V _{OUT(S)} < 2.6 V	–	55	–	dB	5
			2.6 V ≤ V _{OUT(S)} ≤ 5.5 V	–	50	–	dB	5
Short-circuit current	I _{short}	V _{IN} = 2.5 V, ON / OFF pin = ON, V _{OUT} = 0 V, T _a = +25°C V _{OUT(S)} < 1.5 V	–	330	–	mA	3	
		V _{IN} = V _{OUT(S)} + 1.0 V, ON / OFF pin = ON, V _{OUT} = 0 V, T _a = +25°C 1.5 V ≤ V _{OUT(S)}	–	330	–	mA	3	
Thermal shutdown detection temperature	T _{SD}	Junction temperature	–	170	–	°C	–	
Thermal shutdown release temperature	T _{SR}	Junction temperature	–	135	–	°C	–	
Discharge shunt resistance during power-off	R _{LOW}	V _{IN} = 6.5 V, V _{OUT} = 0.1 V	–	100	–	Ω	6	
ON / OFF pin pull-down resistance	R _{PD}	–	1.3	4.0	12	MΩ	4	

- *1. V_{OUT(S)}: Set output voltage
 V_{OUT(E)}: Actual output voltage
 Output voltage when fixing I_{OUT} (= 100 mA) and inputting 2.5 V or V_{OUT(S)} + 1.0 V.
- *2. The output current at which the output voltage becomes 95% of V_{OUT(E)} after gradually increasing the output current.
- *3. V_{drop} = V_{IN1} – (V_{OUT3} × 0.98)
 V_{IN1} is the input voltage at which the output voltage becomes 98% of V_{OUT3} after gradually decreasing the input voltage.
 V_{OUT3} is the output voltage when V_{IN} = V_{OUT(S)} + 1.0 V, and I_{OUT} = 300 mA or 1000 mA.
- *4. The dropout voltage is limited by the difference between the input voltage (min. value) and the set output voltage.
 In case of 1.0 V ≤ V_{OUT(S)} < 1.5 V: 2.5 V – V_{OUT(S)} = V_{drop}
 In case of 1.5 V ≤ V_{OUT(S)} < 2.0 V: (V_{OUT(S)} + 1.0 V) – V_{OUT(S)} = 1.0 V
- *5. Due to limitation of the power dissipation, this value may not be satisfied. Attention should be paid to the power dissipation when the output current is large.
 This specification is guaranteed by design.

■ Test Circuits

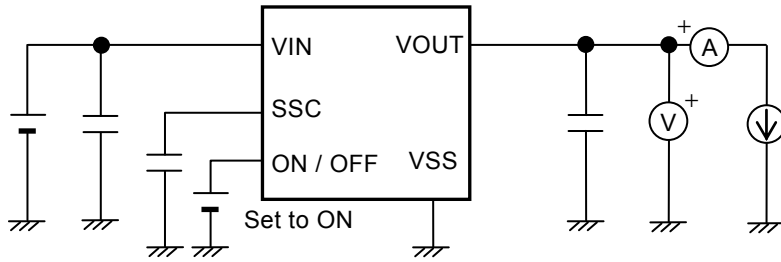

Figure 3 Test Circuit 1

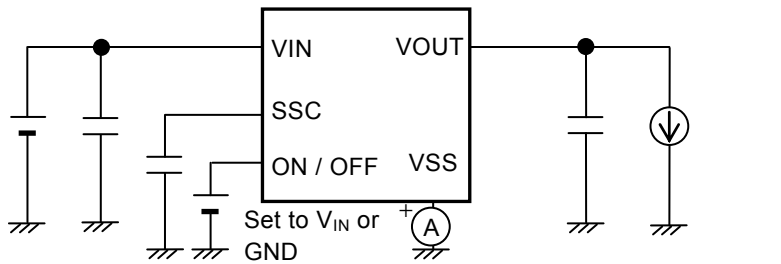

Figure 4 Test Circuit 2

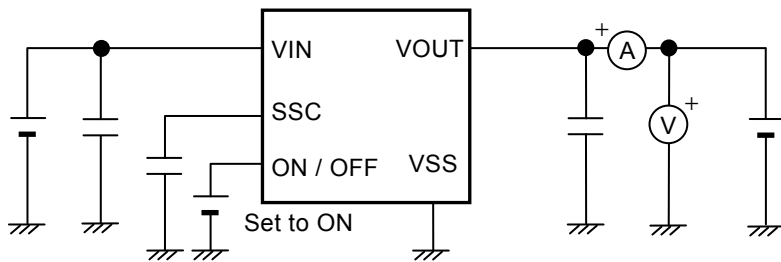

Figure 5 Test Circuit 3

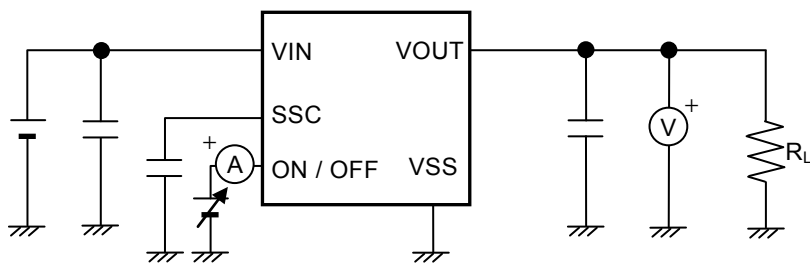

Figure 6 Test Circuit 4

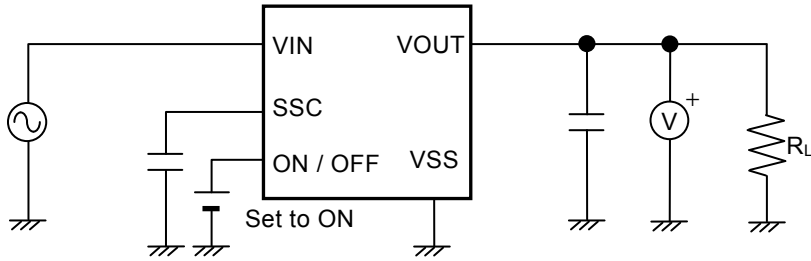

Figure 7 Test Circuit 5

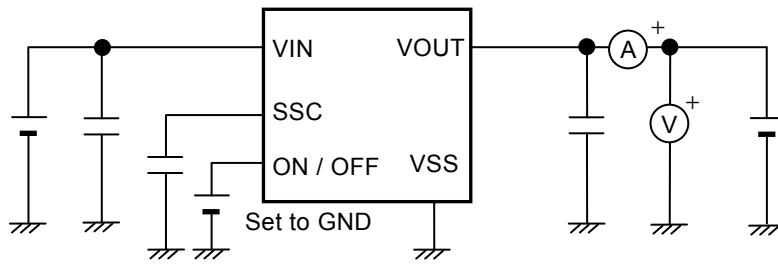
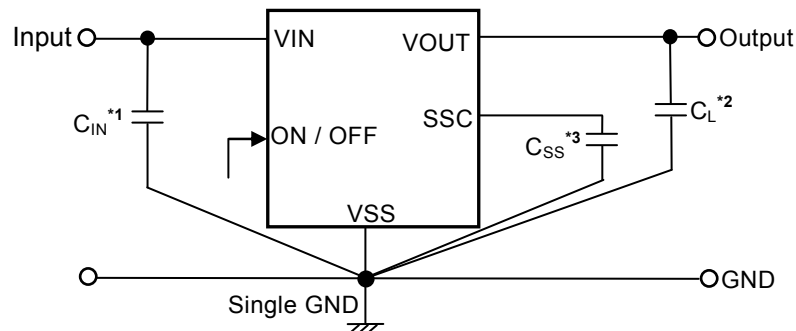

Figure 8 Test Circuit 6

■ Standard Circuit



- *1. C_{IN} is a capacitor for stabilizing the input.
- *2. C_L is a capacitor for stabilizing the output.
- *3. C_{SS} is a capacitor for soft-start.

Figure 9

Caution The above connection diagram and constants will not guarantee successful operation. Perform thorough evaluation including the temperature characteristics with an actual application to set the constants.

■ Condition of Application

Input capacitor (C_{IN}): A ceramic capacitor with capacitance of 2.2 μF or more is recommended.

Output capacitor (C_L): A ceramic capacitor with capacitance of 2.2 μF or more is recommended.

Caution Generally, in a voltage regulator, an oscillation may occur depending on the selection of the external parts. Perform thorough evaluation including the temperature characteristics with an actual application using the above capacitors to confirm no oscillation occurs.

■ Selection of Input Capacitor (C_{IN}) and Output Capacitor (C_L)

The S-19254xxxH Series requires C_L between the VOUT pin and the VSS pin for phase compensation. The operation is stabilized by a ceramic capacitor with capacitance of 2.2 μF or more. When using an OS capacitor, a tantalum capacitor or an aluminum electrolytic capacitor, the capacitance also must be 2.2 μF or more. However, an oscillation may occur depending on the equivalent series resistance (ESR).

Moreover, the S-19254xxxH Series requires C_{IN} between the VIN pin and the VSS pin for a stable operation.

Generally, an oscillation may occur when a voltage regulator is used under the condition that the impedance of the power supply is high.

Note that the output voltage transient characteristics varies depending on the capacitance of C_{IN} and C_L and the value of ESR.

Caution Perform thorough evaluation including the temperature characteristics with an actual application to select C_{IN} and C_L .

■ Selection of Capacitor for Soft-start (C_{SS})

The S-19254xxxH Series requires the capacitor for soft-start (C_{SS}) between the SSC pin and the VSS pin. Over the entire temperature range, the S-19254xxxH Series operates stably with a ceramic capacitor of 0.68 nF or more. According to C_{SS} capacitance, the rising speed of the output voltage is adjustable. The time that the output voltage rises to 99% is 6.0 ms typ. at $C_{SS} = 10$ nF. The recommended value for applications is $0.68 \text{ nF} \leq C_{SS} \leq 168 \text{ nF}$, however; define the values by sufficient evaluation including the temperature characteristics under the usage condition.

■ Explanation of Terms

1. Low dropout voltage regulator

This is a voltage regulator which made dropout voltage small by its built-in low on-resistance output transistor.

2. Output voltage (V_{OUT})

This voltage is output at an accuracy of $\pm 3.0\%$ when the input voltage, the output current and the temperature are in a certain condition*1.

*1. Differs depending on the product.

Caution If the certain condition is not satisfied, the output voltage may exceed the accuracy range of $\pm 3.0\%$. Refer to "■ Electrical Characteristics" and "■ Characteristics (Typical Data)" for details.

3. Line regulation $\left(\frac{\Delta V_{OUT1}}{\Delta V_{IN} \bullet V_{OUT}} \right)$

Indicates the dependency of the output voltage against the input voltage. That is, the value shows how much the output voltage changes due to a change in the input voltage after fixing output current constant.

4. Load regulation (ΔV_{OUT2})

Indicates the dependency of the output voltage against the output current. That is, the value shows how much the output voltage changes due to a change in the output current after fixing input voltage constant.

5. Dropout voltage (V_{drop})

Indicates the difference between input voltage (V_{IN1}) and the output voltage when the output voltage becomes 98% of the output voltage value (V_{OUT3}) at $V_{IN} = V_{OUT(S)} + 1.0$ V after the input voltage (V_{IN}) is decreased gradually.

$$V_{drop} = V_{IN1} - (V_{OUT3} \times 0.98)$$

■ Operation

1. Basic operation

Figure 10 shows the block diagram of the S-19254xxxH Series to describe the basic operation.

The error amplifier compares the feedback voltage (V_{fb}) whose output voltage (V_{OUT}) is divided by the feedback resistors (R_s and R_f) with the reference voltage (V_{ref}). The error amplifier controls the output transistor, consequently, the regulator starts the operation that keeps V_{OUT} constant without the influence of the input voltage (V_{IN}).

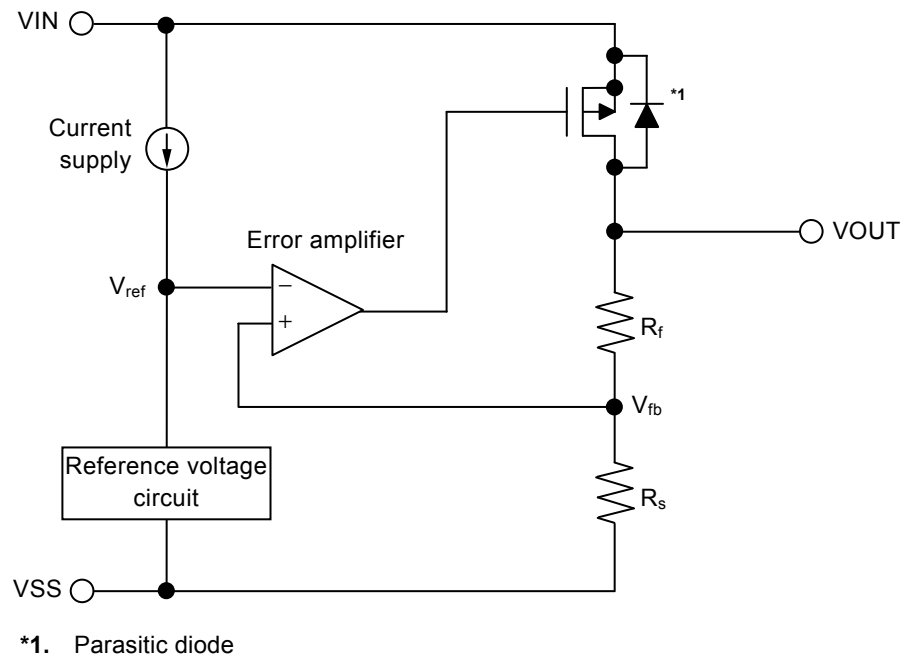

Figure 10

2. Output transistor

In the S-19254xxxH Series, a low on-resistance P-channel MOS FET is used between the V_{IN} pin and the V_{OUT} pin as the output transistor. In order to keep V_{OUT} constant, the on-resistance of the output transistor varies appropriately according to the output current (I_{OUT}).

Caution Since a parasitic diode exists between the V_{IN} pin and the V_{OUT} pin due to the structure of the transistor, the IC may be damaged by a reverse current if V_{OUT} becomes higher than V_{IN} . Therefore, be sure that V_{OUT} does not exceed $V_{IN} + 0.3$ V.

3. ON / OFF pin

The ON / OFF pin controls the internal circuit and the output transistor in order to start and stop the regulator. When the ON / OFF pin is set to OFF, the internal circuit stops operating and the output transistor between the VIN pin and the VOUT pin is turned off, reducing current consumption significantly.

Note that the current consumption increases when a voltage of 0.6 V to $V_{IN} - 0.3$ V is applied to the ON / OFF pin.

The ON / OFF pin is configured as shown in **Figure 11**.

Since the ON / OFF pin is internally pulled down to the VSS pin in the floating status, the VOUT pin is set to the V_{SS} level. Refer to "■ **Electrical Characteristics**" for the ON / OFF pin current.

Table 7

ON / OFF Pin	Internal Circuit	VOUT Pin Voltage	Current Consumption
"H" : ON	Operate	Constant value ^{*1}	I_{SS1} ^{*2}
"L" : OFF	Stop	Pulled down to V_{SS} ^{*3}	I_{SS2}

*1. The constant value is output due to the regulating based on the set output voltage value.

*2. Note that the IC's current consumption increases as much as current flows into the pull-down resistor when the ON / OFF pin is connected to the VIN pin and the S-19254xxxH Series is operating (refer to **Figure 11**).

*3. The VOUT pin voltage is pulled down to V_{SS} due to the discharge shunt circuit ($R_{LOW} = 100 \Omega$ typ.), the feedback resistors (R_s and R_f) and a load.

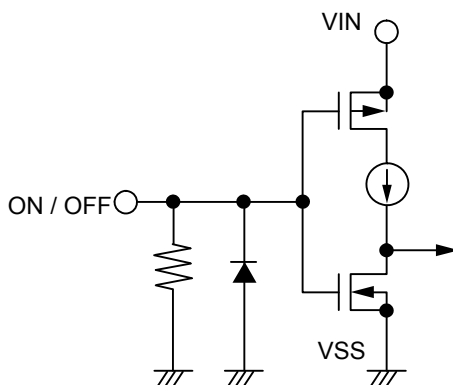

Figure 11

4. Discharge shunt function

The S-19254xxxH Series has a built-in discharge shunt circuit to discharge the output capacitance. The output capacitance is discharged as follows so that the VOUT pin reaches the V_{SS} level.

- (1) The ON / OFF pin is set to OFF level.
- (2) The output transistor is turned off.
- (3) The discharge shunt circuit is turned on.
- (4) The output capacitor discharges.

The S-19254xxxH Series allows the VOUT pin to reach the V_{SS} level rapidly due to the discharge shunt circuit.

S-19254xxxH Series

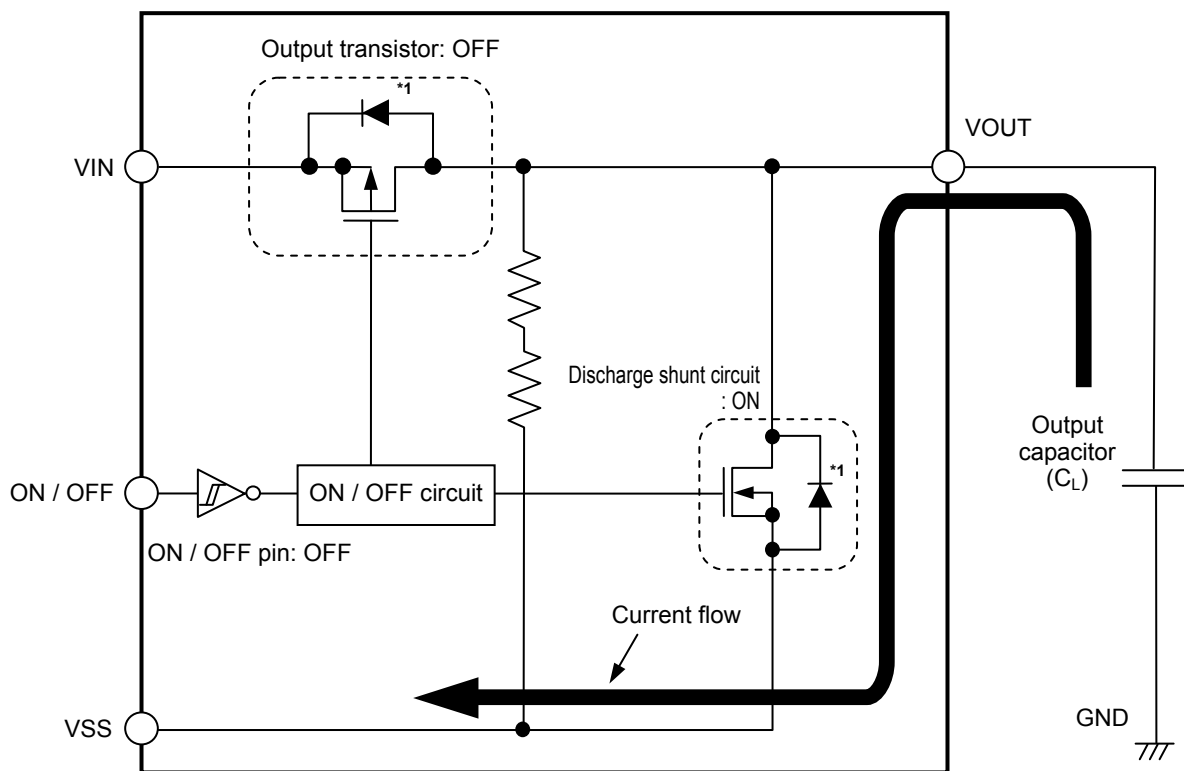

*1. Parasitic diode

Figure 12

5. Pull-down resistor

The ON / OFF pin is internally pulled down to the VSS pin in the floating status, so the VOUT pin is set to the V_{SS} level.

Note that the IC's current consumption increases as much as current flows into the pull-down resistor of 4.0 MΩ typ. when the ON / OFF pin is connected to the VIN pin.

6. Overcurrent protection circuit

The S-19254xxxH Series has a built-in overcurrent protection circuit to limit the overcurrent of the output transistor. When the VOUT pin is shorted to the VSS pin, that is, at the time of the output short-circuit, the output current is limited to 330 mA typ. due to the overcurrent protection circuit operation. The S-19254xxxH Series restarts regulating when the output transistor is released from the overcurrent status.

Caution This overcurrent protection circuit does not work as for thermal protection. For example, when the output transistor keeps the overcurrent status long at the time of output short-circuit or due to other reasons, pay attention to the conditions of the input voltage and the load current so as not to exceed the power dissipation.

7. Thermal shutdown circuit

The S-19254xxxH Series has a built-in thermal shutdown circuit to limit overheating. When the junction temperature increases to 170°C typ., the thermal shutdown circuit becomes the detection status, and the regulating is stopped. When the junction temperature decreases to 135°C typ., the thermal shutdown circuit becomes the release status, and the regulator is restarted.

If the thermal shutdown circuit becomes the detection status due to self-heating, the regulating is stopped and V_{OUT} decreases. For this reason, the self-heating is limited and the temperature of the IC decreases. The thermal shutdown circuit becomes release status when the temperature of the IC decreases, and the regulating is restarted after the soft-start operation is finished, thus the self-heating is generated again. Repeating this procedure makes the waveform of V_{OUT} into a pulse-like form. This phenomenon continues unless decreasing either or both of the input voltage and the output current in order to reduce the internal power consumption, or decreasing the ambient temperature. Note that the product may suffer physical damage such as deterioration if the above phenomenon occurs continuously.

Caution When the heat radiation of the application is not in a good condition, the self-heating cannot be limited immediately, and the IC may suffer physical damage. Perform thorough evaluation with an actual application to confirm no problems happen.

Table 8

Thermal Shutdown Circuit	VOUT Pin Voltage
Release: 135°C typ.*1	Constant value*2
Detection: 170°C typ.*1	Pulled down to V _{SS} *3

*1. Junction temperature

*2. The constant value is output due to the regulating based on the set output voltage value.

*3. The VOUT pin voltage is pulled down to V_{SS} due to the feedback resistors (R_s and R_f) and a load.

8. Soft-start function

The S-19254xxxH Series has the built-in soft-start circuit to suppress the inrush current and overshoot of the output voltage generated at power-on or at the time when the ON / OFF pin is set to ON. The soft-start time (t_{SS}) is the time period from when the output voltage rises slowly immediately after power-on or when the ON / OFF pin is set to ON until when the output voltage rises to 99%.

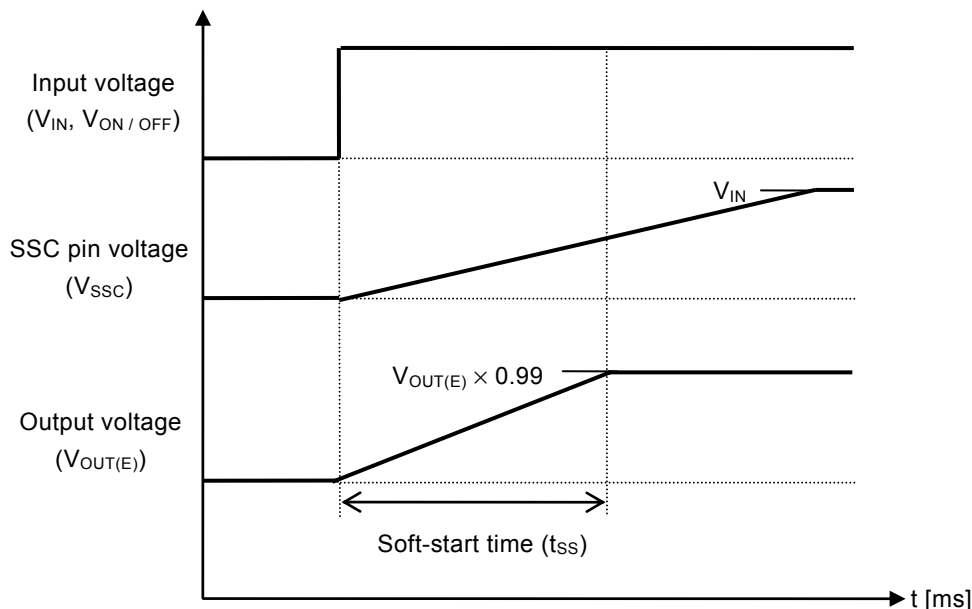

Figure 13

8.1 Soft-start time

t_{SS} can be adjusted by the external capacitor (C_{SS}) connected between the SSC pin and the VSS pin, and is calculated by using the following calculation.

$$t_{SS} [\text{ms}] = \text{Soft-start coefficient}^{*1} [\text{ms} / \text{nF}] \times C_{SS} [\text{nF}] + t_{D0}^{*2} [\text{ms}]$$

*1. It is determined by charging the built-in constant current (approx. 2.1 μA) to C_{SS} .

*2. The delay time of internal capacitance.

When the C_{SS} value is sufficiently large, the t_{D0} value can be disregarded. When the ON / OFF pin is set to OFF, the electrical charge charged in C_{SS} is discharged by the transistor of the discharge shunt circuit.

Table 9 Soft-start Coefficient [ms / nF]

Operation Temperature	Min.	Typ.	Max.
$T_j = +105^\circ\text{C}$	0.398	0.539	0.690
$T_j = +25^\circ\text{C}$	0.436	0.574	0.704
$T_j = -40^\circ\text{C}$	0.467	0.604	0.717

Table 10 Delay Time of Internal Capacitance (t_{D0})

Operation Temperature	Min.	Typ.	Max.
$T_j = -40^\circ\text{C}$ to $+105^\circ\text{C}$	0.032 ms	0.047 ms	0.108 ms

Caution The above calculation will not guarantee successful operation. Perform thorough evaluation using the actual application including the temperature characteristics under the actual usage conditions to determine C_{SS} capacitance. Refer to "■ Condition of Application" and "■ Characteristics (Typical Data)" for details.

■ Precautions

- Generally, when a voltage regulator is used under the condition that the load current value is small (1 mA or less), the output voltage may increase due to the leakage current of an output transistor.
- Generally, when a voltage regulator is used under the condition that the temperature is high, the output voltage may increase due to the leakage current of an output transistor.
- Generally, when the ON / OFF pin is used under the condition of OFF, the output voltage may increase due to the leakage current of an output transistor.
- Generally, when a voltage regulator is used under the condition that the impedance of the power supply is high, an oscillation may occur. Perform thorough evaluation including the temperature characteristics with an actual application to select C_{IN} .
- Generally, in a voltage regulator, an oscillation may occur depending on the selection of the external parts. The following use conditions are recommended in the S-19254xxxH Series; however, perform thorough evaluation including the temperature characteristics with an actual application to select C_{IN} and C_L .
 - Input capacitor (C_{IN}): A ceramic capacitor with capacitance of 2.2 μ F or more is recommended.
 - Output capacitor (C_L): A ceramic capacitor with capacitance of 2.2 μ F or more is recommended.
- Generally, in a voltage regulator, the values of an overshoot and an undershoot in the output voltage vary depending on the variation factors of input voltage start-up, input voltage fluctuation, load fluctuation etc., or the capacitance of C_{IN} or C_L and the value of the equivalent series resistance (ESR), which may cause a problem to the stable operation. Perform thorough evaluation including the temperature characteristics with an actual application to select C_{IN} and C_L .
- Generally, in a voltage regulator, an overshoot may occur in the output voltage momentarily if the input voltage steeply changes when the input voltage is started up, the soft-start operation is performed, the input voltage fluctuates, etc. Perform thorough evaluation including the temperature characteristics with an actual application to confirm no problems happen.
- Generally, in a voltage regulator, if the VOUT pin is steeply shorted with GND, a negative voltage exceeding the absolute maximum ratings may occur in the VOUT pin due to resonance phenomenon of the inductance and the capacitance including C_L on the application. The resonance phenomenon is expected to be weakened by inserting a series resistor into the resonance path, and the negative voltage is expected to be limited by inserting a protection diode between the VOUT pin and the VSS pin.
- If the input voltage is started up steeply under the condition that the capacitance of C_L is large, the thermal shutdown circuit may be in the detection status by self-heating due to the charge current to C_L .
- Make sure of the conditions for the input voltage, output voltage and the load current so that the internal loss does not exceed the power dissipation.
- Do not apply an electrostatic discharge to this IC that exceeds the performance ratings of the built-in electrostatic protection circuit.
- When considering the output current value that the IC is able to output, make sure of the output current value specified in **Table 6** in "■ Electrical Characteristics" and footnote *5 of the table.
- Wiring patterns on the application related to the VIN pin, the VOUT pin and the VSS pin should be designed so that the impedance is low. When mounting C_{IN} between the VIN pin and the VSS pin and C_L between the VOUT pin and the VSS pin, connect the capacitors as close as possible to the respective destination pins of the IC.
- In the package equipped with heat sink of backside, mount the heat sink firmly. Since the heat radiation differs according to the condition of the application, perform thorough evaluation with an actual application to confirm no problems happen.
- SII Semiconductor Corporation claims no responsibility for any disputes arising out of or in connection with any infringement by products including this IC of patents owned by a third party.

■ **Characteristics (Typical Data)**

1. Output voltage vs. Output current (When load current increases) (Ta = +25°C)

1.1 V_{OUT} = 1.0 V

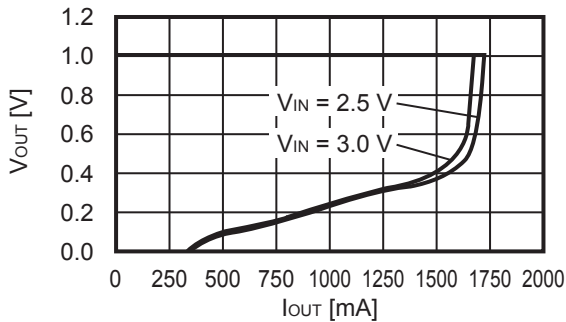

1.2 V_{OUT} = 3.0 V

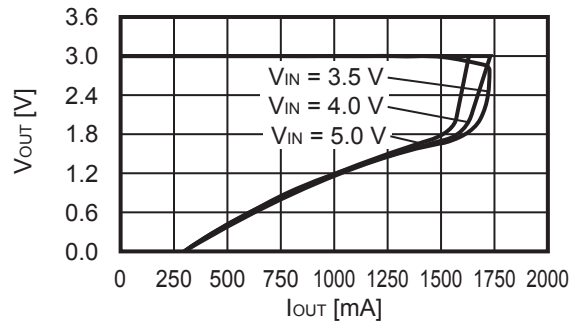

Remark In determining the output current, attention should be paid to the following.

1. The minimum output current value and footnote *5 of Table 6 in "■ Electrical Characteristics"
2. Power dissipation

2. Output voltage vs. Input voltage (Ta = +25°C)

2.1 V_{OUT} = 1.0 V

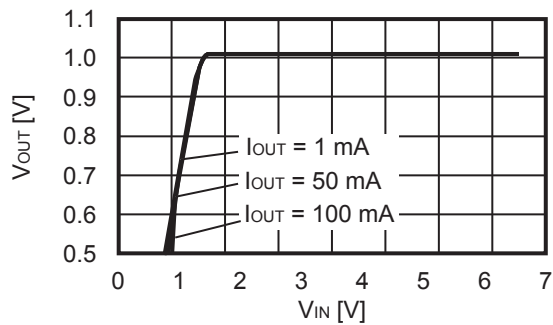

2.2 V_{OUT} = 3.0 V

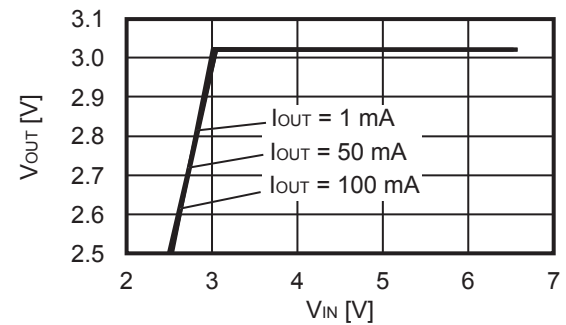

3. Dropout voltage vs. Output current

3.1 V_{OUT} = 1.0 V

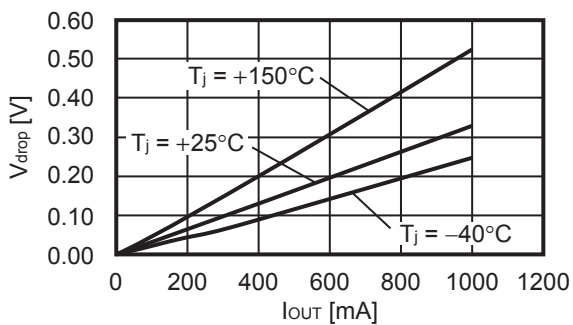

4. Dropout voltage vs. Junction temperature

4.1 V_{OUT} = 3.0 V

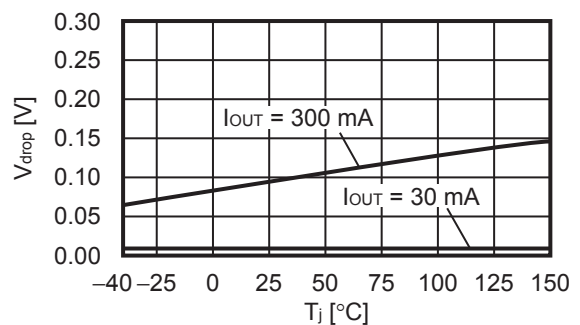

5. Dropout voltage vs. Set output voltage (Ta = +25°C)

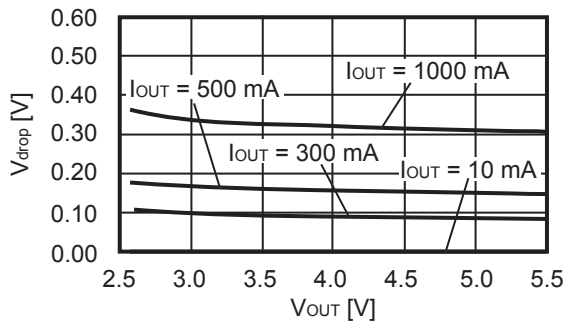

6. Output voltage vs. Junction temperature

6.1 $V_{OUT} = 1.0\text{ V}$

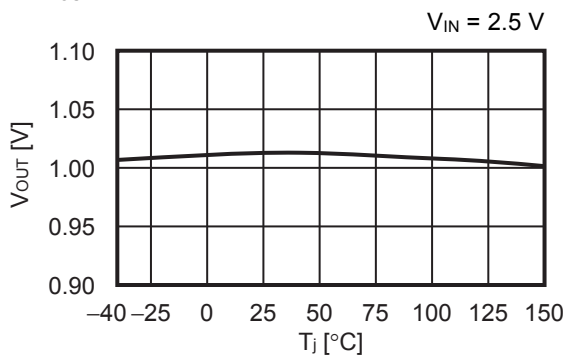

6.2 $V_{OUT} = 3.0\text{ V}$

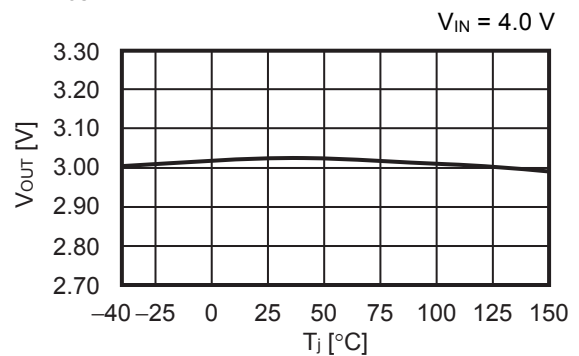

7. Current consumption during operation vs. Input voltage (When ON / OFF pin is ON, no load)

7.1 $V_{OUT} = 1.0\text{ V}$

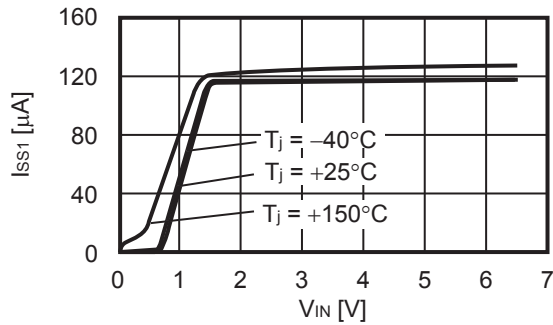

7.2 $V_{OUT} = 3.0\text{ V}$

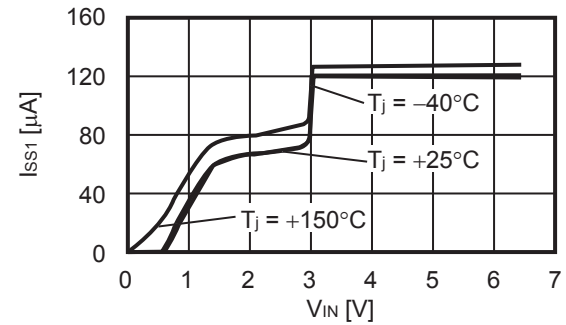

8. Current consumption during operation vs. Junction temperature

8.1 $V_{OUT} = 1.0\text{ V}$

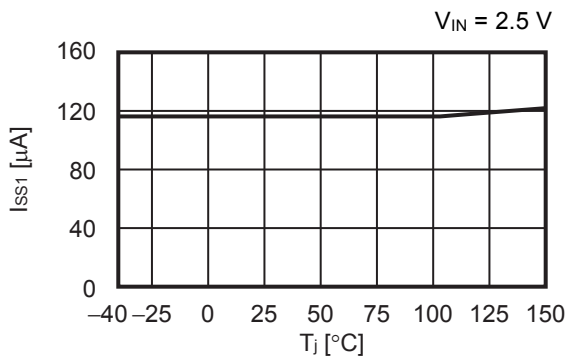

8.2 $V_{OUT} = 3.0\text{ V}$

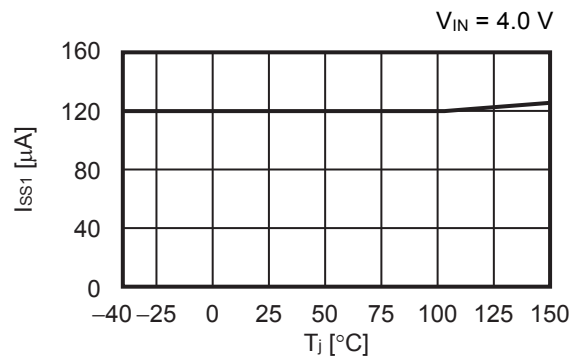

9. Current consumption during operation vs. Output current (Ta = +25°C)

9.1 V_{OUT} = 1.0 V

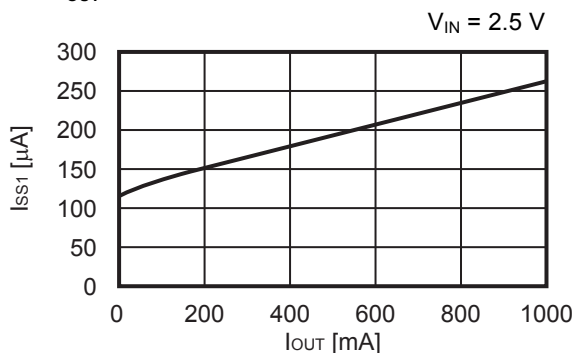

9.2 V_{OUT} = 3.0 V

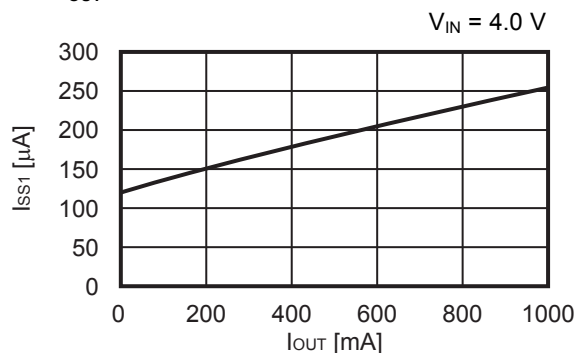

10. Ripple rejection (Ta = +25°C)

10.1 V_{OUT} = 1.0 V

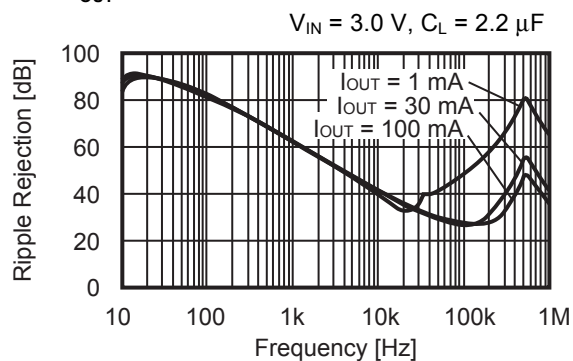

10.2 V_{OUT} = 3.0 V

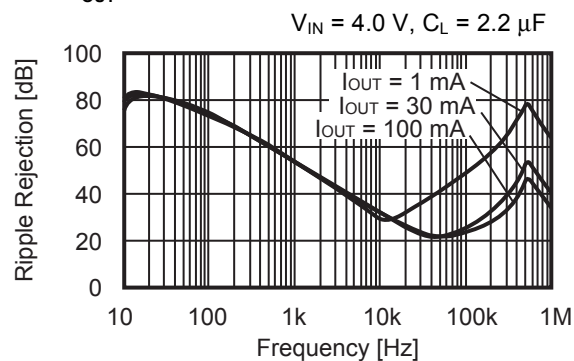

■ Reference Data

1. Characteristics of input transient response (Ta = +25°C)

1.1 V_{OUT} = 1.0 V

I_{OUT} = 100 mA, C_L = 2.2 μF, V_{IN} = 2.5 V ↔ 3.5 V, t_r = t_f = 5.0 μs

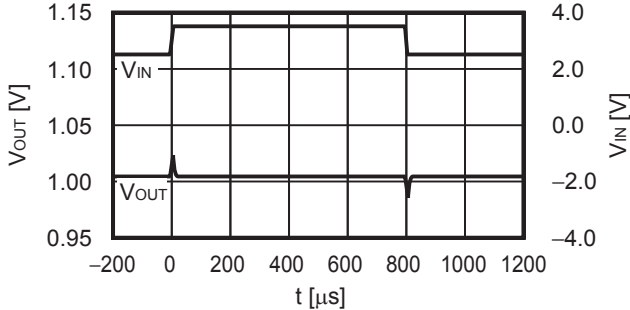

1.2 V_{OUT} = 3.0 V

I_{OUT} = 100 mA, C_L = 2.2 μF, V_{IN} = 4.0 V ↔ 5.0 V, t_r = t_f = 5.0 μs

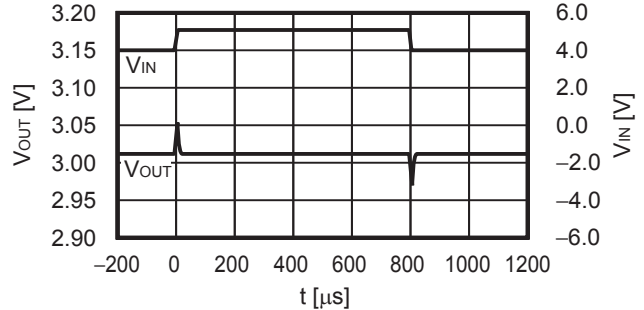

2. Characteristics of load transient response (Ta = +25°C)

2.1 V_{OUT} = 1.0 V

V_{IN} = 2.5 V, C_L = 2.2 μF, I_{OUT} = 50 mA ↔ 100 mA

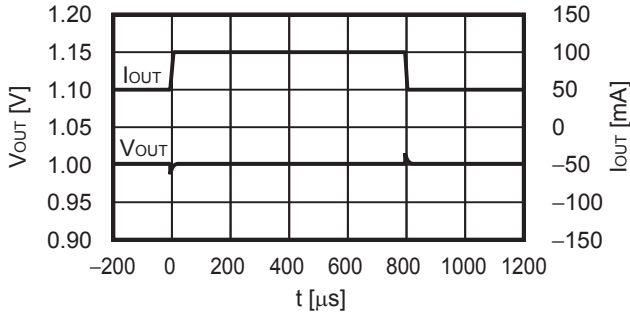

V_{IN} = 2.5 V, C_L = 2.2 μF, I_{OUT} = 100 mA ↔ 500 mA

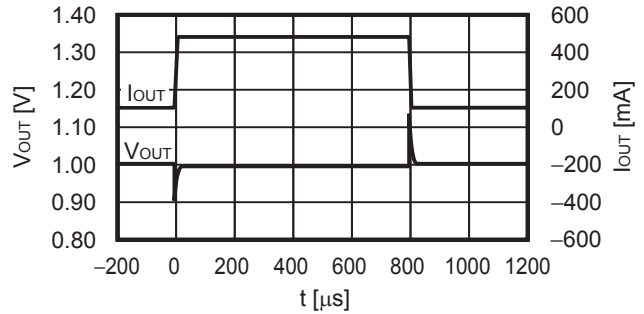

2.2 V_{OUT} = 3.0 V

V_{IN} = 4.0 V, C_L = 2.2 μF, I_{OUT} = 50 mA ↔ 100 mA

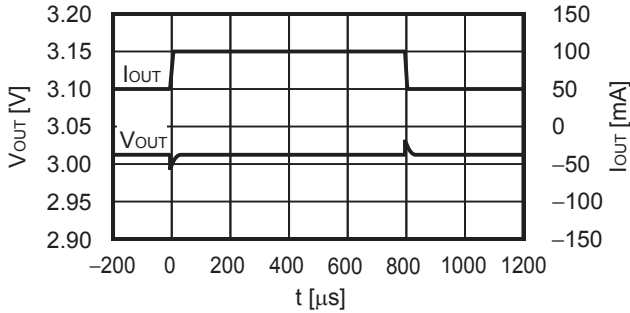

V_{IN} = 4.0 V, C_L = 2.2 μF, I_{OUT} = 100 mA ↔ 500 mA

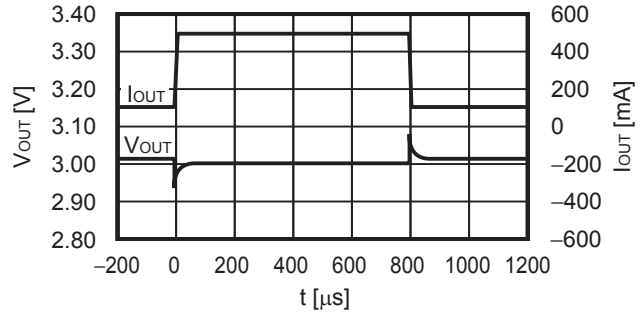

3. Transient response characteristics of ON / OFF pin (Ta = +25°C)

3.1 V_{OUT} = 1.0 V

V_{IN} = 2.5 V, C_{IN} = C_L = 2.2 μF,
 I_{OUT} = 100 mA, V_{ON / OFF} = 0 V → 2.5 V

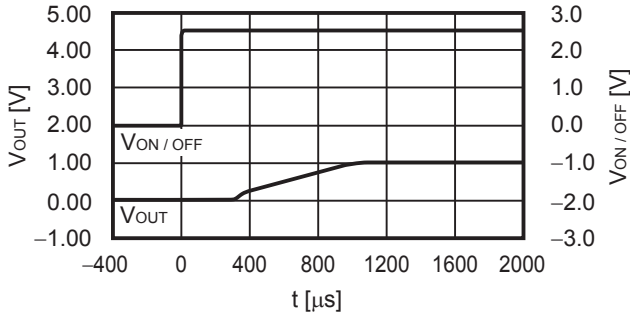

3.2 V_{OUT} = 3.0 V

V_{IN} = 4.0 V, C_{IN} = C_L = 2.2 μF,
 I_{OUT} = 100 mA, V_{ON / OFF} = 0 V → 4.0 V

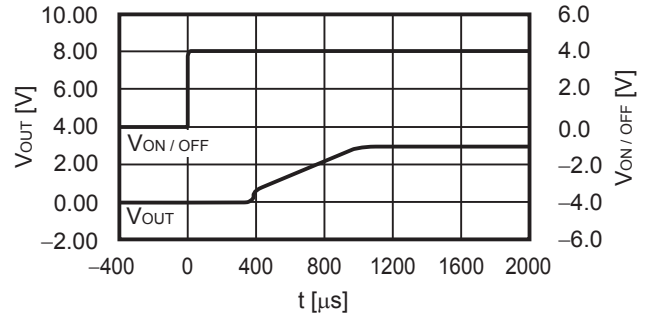

4. Soft-start time vs. Characteristics of operation ambient temperature

V_{IN} = 2.5 V, V_{ON / OFF} = 0 V → 2.5 V (V_{OUT(S)} < 1.5 V),
 V_{IN} = V_{OUT} + 1.0 V, V_{ON / OFF} = 0 V → V_{OUT} + 1.0 V (1.5 V ≤ V_{OUT(S)}),
 C_{IN} = C_L = 2.2 μF, C_{SS} = 10 nF

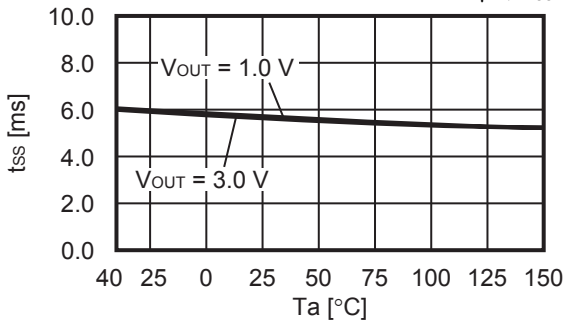

5. Soft-start time vs. Characteristics of soft-start capacitance (Ta = +25°C)

V_{IN} = 2.5 V, V_{ON / OFF} = 0 V → 2.5 V (V_{OUT(S)} < 1.5 V),
 V_{IN} = V_{OUT} + 1.0 V, V_{ON / OFF} = 0 V → V_{OUT} + 1.0 V (1.5 V ≤ V_{OUT(S)}),
 C_{IN} = C_L = 2.2 μF

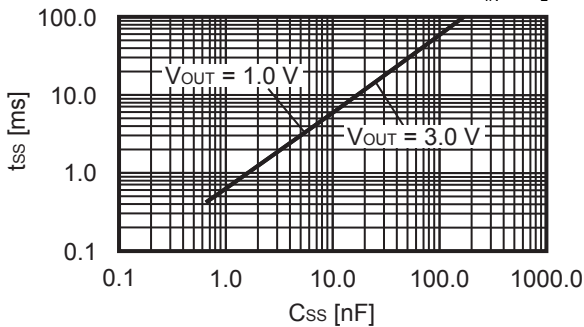

6. Inrush current characteristics (Ta = +25°C)

6.1 V_{OUT} = 1.0 V

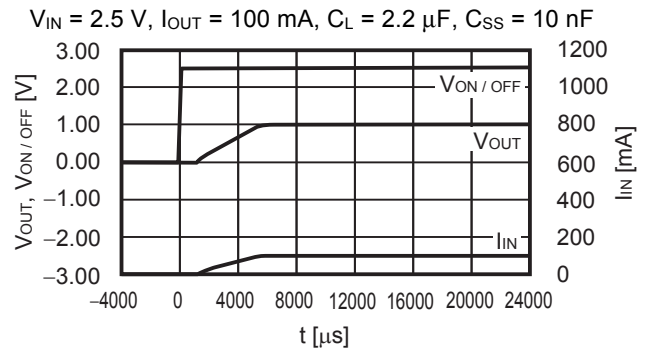
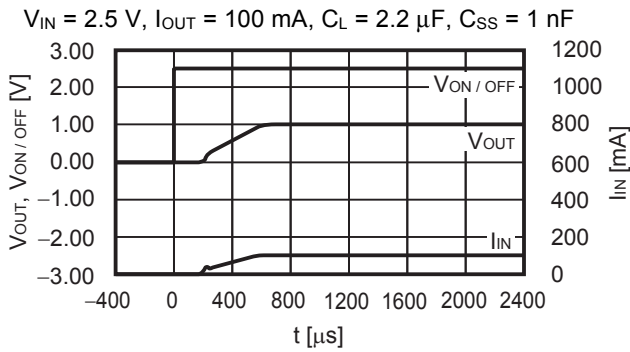

6.2 V_{OUT} = 3.0 V

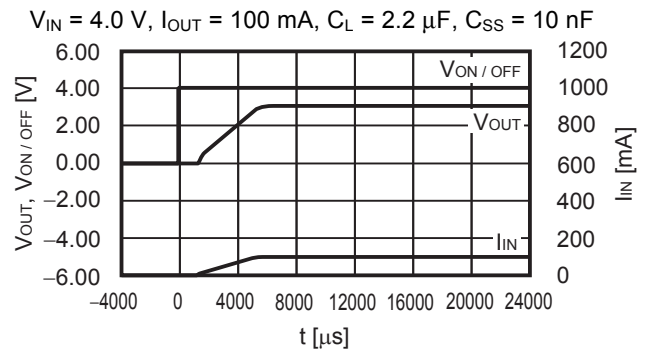
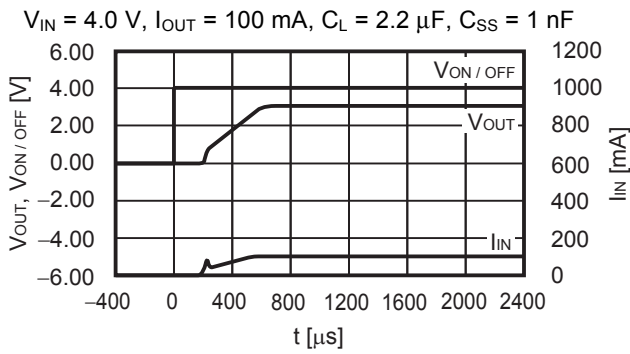

7. Output capacitance vs. Characteristics of discharge time (Ta = +25°C)

$V_{IN} = 2.5\text{ V}, V_{ON/OFF} = 2.5\text{ V} \rightarrow V_{SS} (V_{OUT(S)} < 1.5\text{ V}),$
 $V_{IN} = V_{OUT} + 1.0\text{ V}, V_{ON/OFF} = V_{OUT} + 1.0\text{ V} \rightarrow V_{SS} (1.5\text{ V} \leq V_{OUT(S)}),$
 $I_{OUT} = 1\text{ mA}, t_f = 1\text{ }\mu\text{s}$

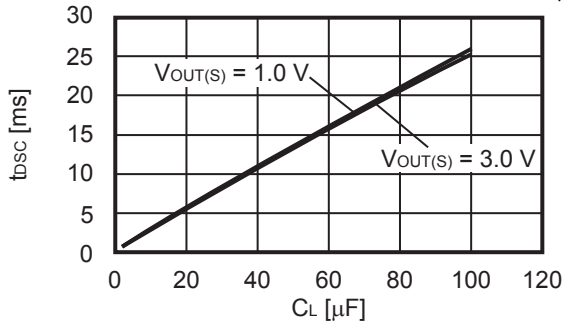
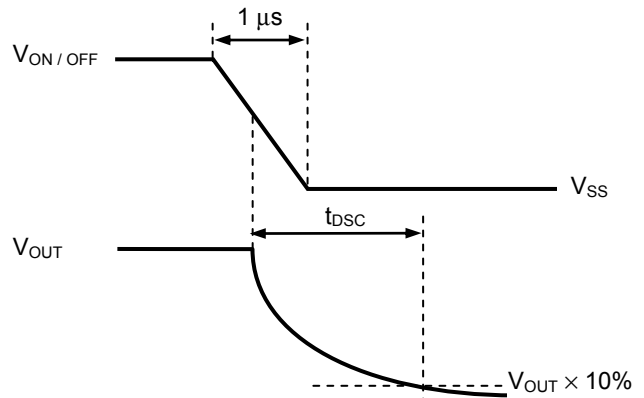

Figure 14 With Discharge Shunt Function



$V_{IN} = 2.5\text{ V}, V_{ON/OFF} = 2.5\text{ V} \rightarrow V_{SS} (V_{OUT(S)} < 1.5\text{ V}),$
 $V_{IN} = V_{OUT} + 1.0\text{ V}, V_{ON/OFF} = V_{OUT} + 1.0\text{ V} \rightarrow V_{SS} (1.5\text{ V} \leq V_{OUT(S)})$

Figure 15 Measurement Condition of Discharge Time

8. Example of equivalent series resistance vs. Output current characteristics (Ta = +25°C)

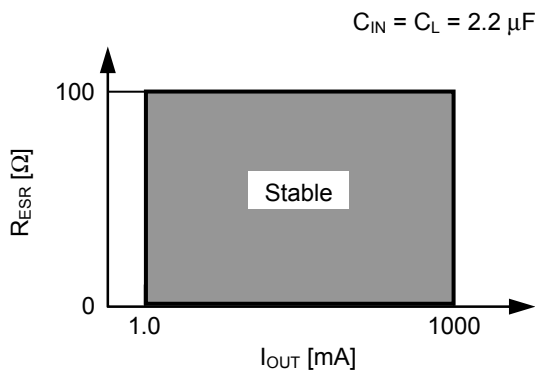
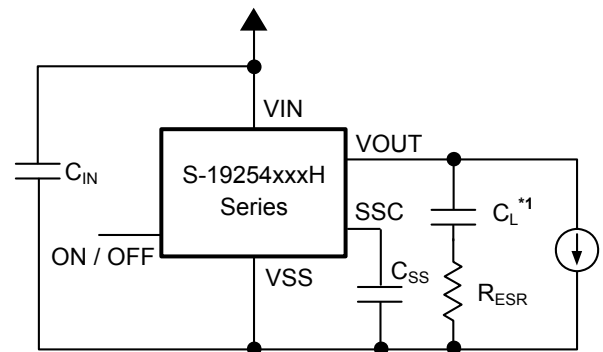

Figure 16



*1. CL: TDK Corporation CGA6M2X8R1E225K (2.2 μF)

Figure 17

■ Power Dissipation

HSOP-8A

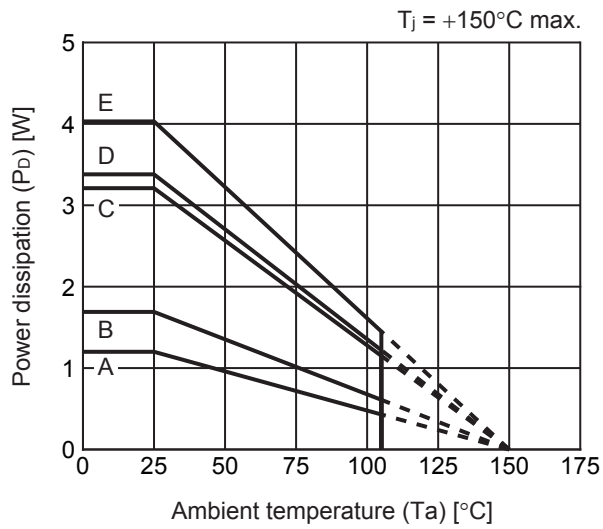

Board	Power Dissipation (P_D)
A	1.20 W
B	1.69 W
C	3.21 W
D	3.38 W
E	4.03 W

HSOP-8A Test Board

(1) Board A

 IC Mount Area

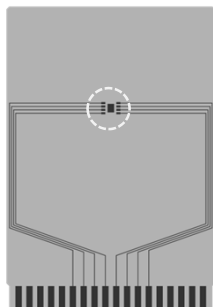

Item	Specification	
Size [mm]	114.3 x 76.2 x t1.6	
Material	FR-4	
Number of copper foil layer	2	
Copper foil layer [mm]	1	Land pattern and wiring for testing: t0.070
	2	-
	3	-
	4	74.2 x 74.2 x t0.070
Thermal via	-	

(2) Board B

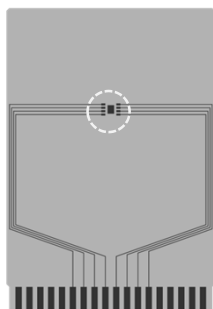

Item	Specification	
Size [mm]	114.3 x 76.2 x t1.6	
Material	FR-4	
Number of copper foil layer	4	
Copper foil layer [mm]	1	Land pattern and wiring for testing: t0.070
	2	74.2 x 74.2 x t0.035
	3	74.2 x 74.2 x t0.035
	4	74.2 x 74.2 x t0.070
Thermal via	-	

(3) Board C

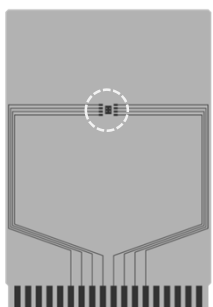

Item	Specification	
Size [mm]	114.3 x 76.2 x t1.6	
Material	FR-4	
Number of copper foil layer	4	
Copper foil layer [mm]	1	Land pattern and wiring for testing: t0.070
	2	74.2 x 74.2 x t0.035
	3	74.2 x 74.2 x t0.035
	4	74.2 x 74.2 x t0.070
Thermal via	Number: 4 Diameter: 0.3 mm	

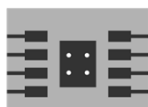

enlarged view

No. HSOP8A-A-Board-SD-1.0

HSOP-8A Test Board

(4) Board D

 IC Mount Area

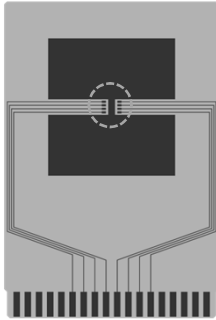

Item	Specification	
Size [mm]	114.3 x 76.2 x t1.6	
Material	FR-4	
Number of copper foil layer	4	
Copper foil layer [mm]	1	Pattern for heat radiation: 2000mm ² t0.070
	2	74.2 x 74.2 x t0.035
	3	74.2 x 74.2 x t0.035
	4	74.2 x 74.2 x t0.070
Thermal via	-	

(5) Board E

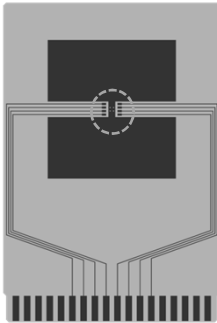

Item	Specification	
Size [mm]	114.3 x 76.2 x t1.6	
Material	FR-4	
Number of copper foil layer	4	
Copper foil layer [mm]	1	Pattern for heat radiation: 2000mm ² t0.070
	2	74.2 x 74.2 x t0.035
	3	74.2 x 74.2 x t0.035
	4	74.2 x 74.2 x t0.070
Thermal via	Number: 4 Diameter: 0.3 mm	



enlarged view

No. HSOP8A-A-Board-SD-1.0

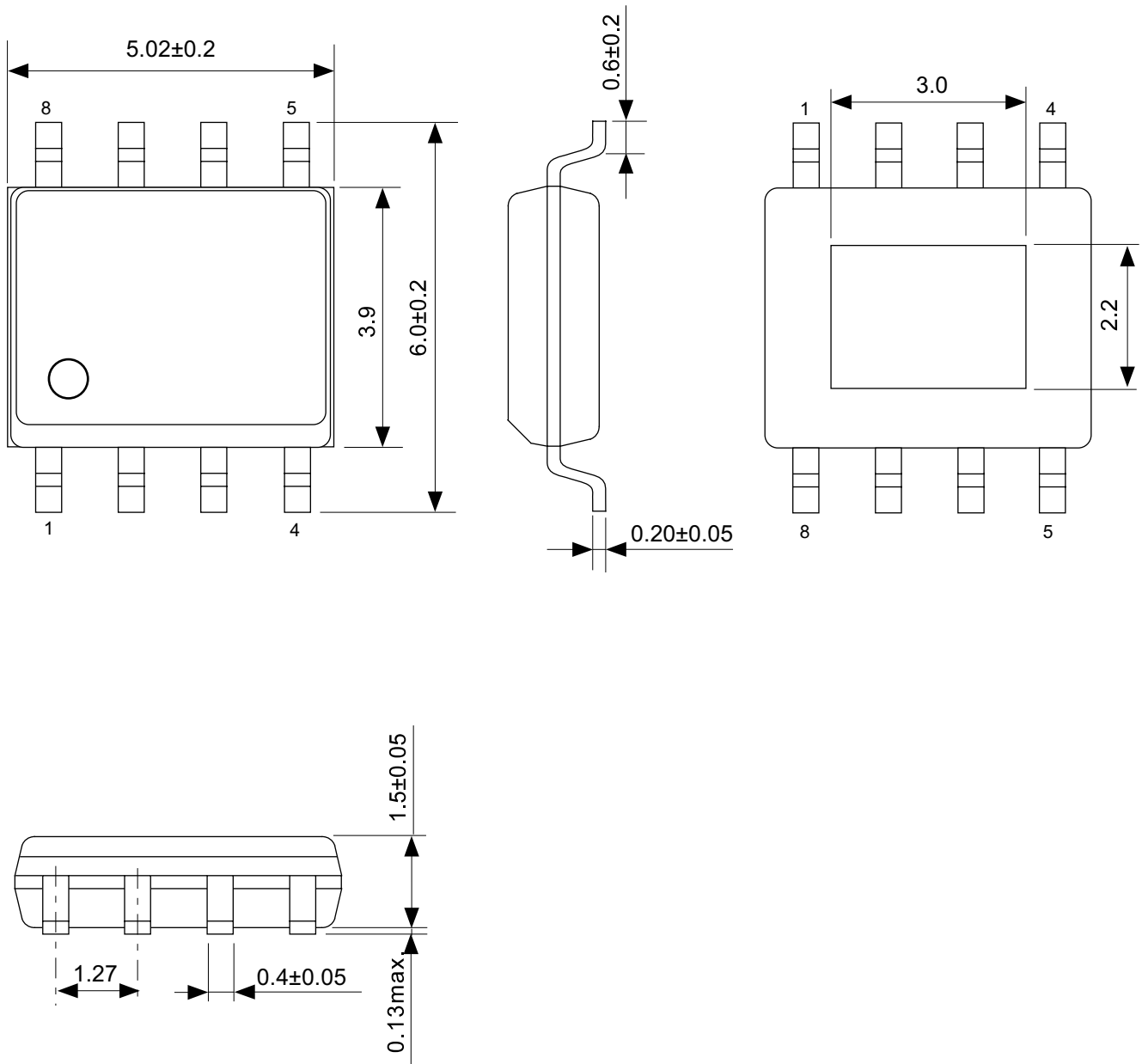

No. FH008-A-P-SD-2.0

TITLE	HSOP8A-A-PKG Dimensions
No.	FH008-A-P-SD-2.0
ANGLE	
UNIT	mm
SII Semiconductor Corporation	

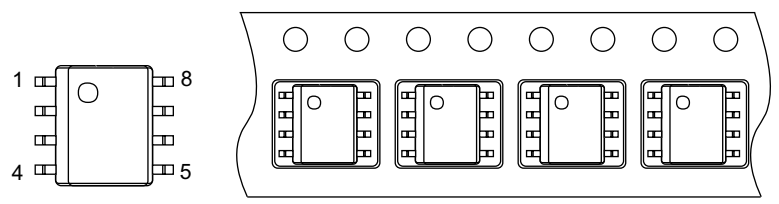
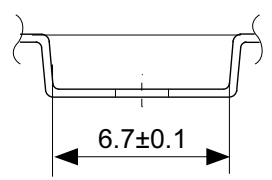
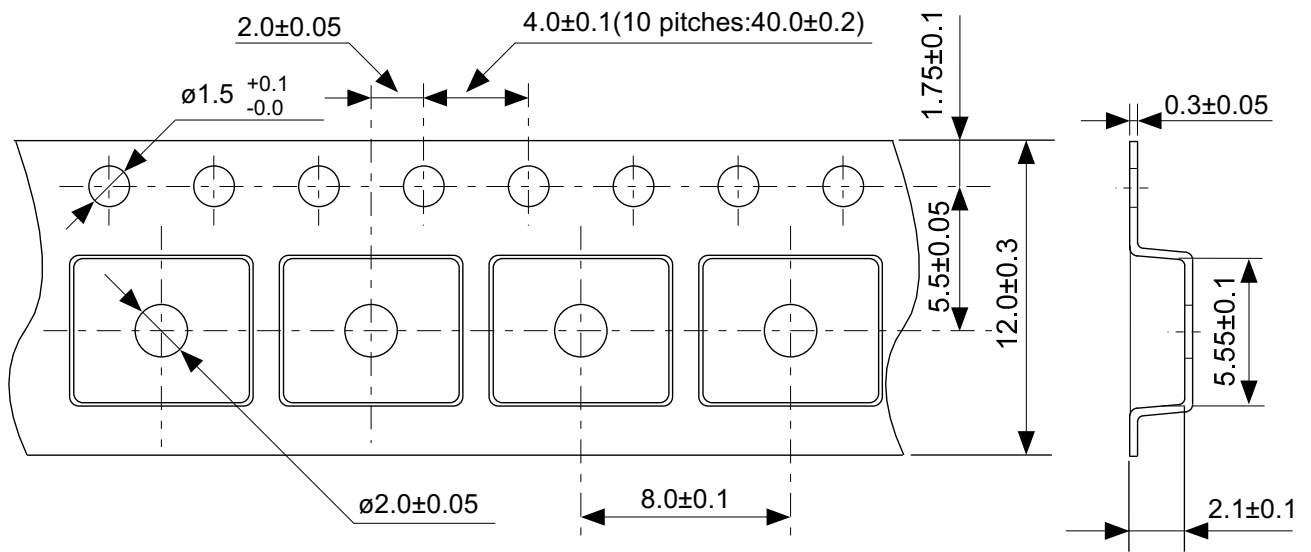

→
Feed direction

No. FH008-A-C-SD-1.0

TITLE	HSOP8A-A-Carrier Tape
No.	FH008-A-C-SD-1.0
ANGLE	
UNIT	mm

SII Semiconductor Corporation

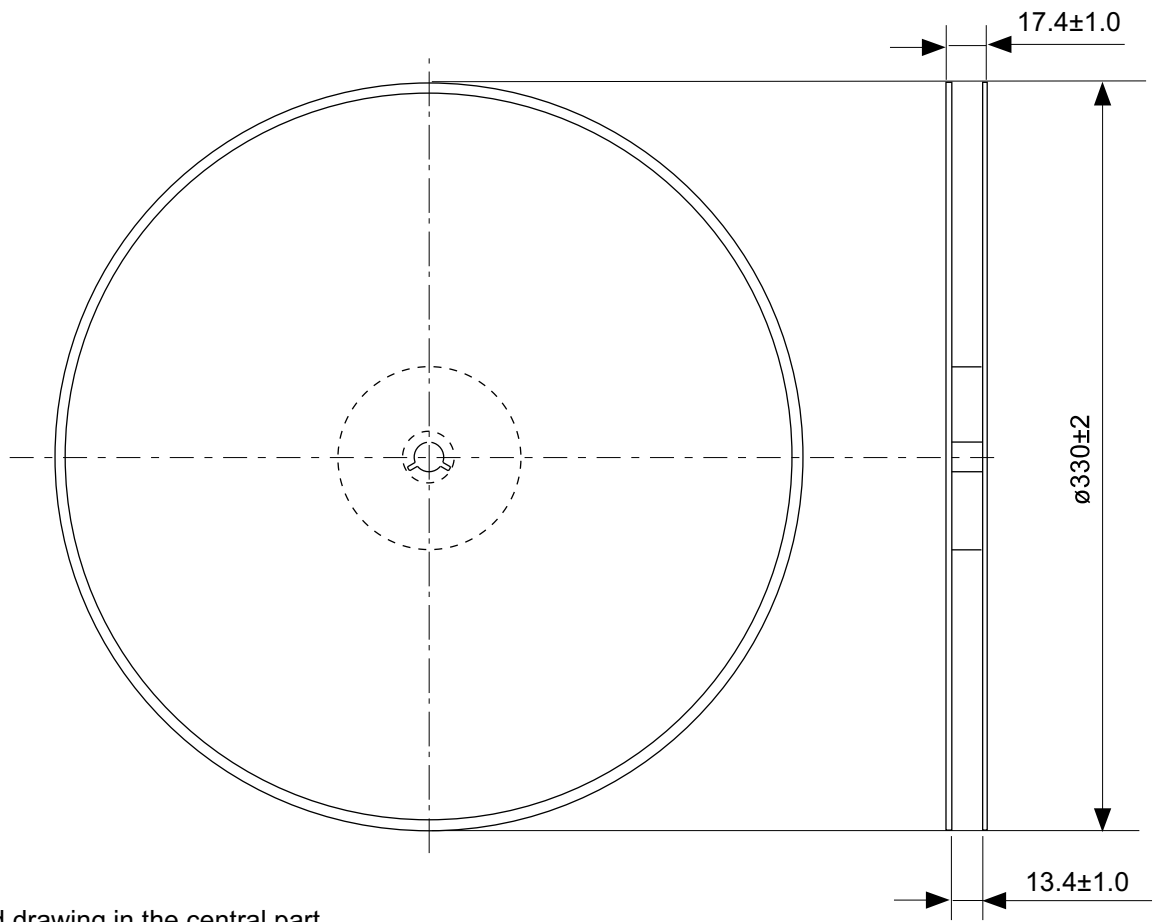

Enlarged drawing in the central part

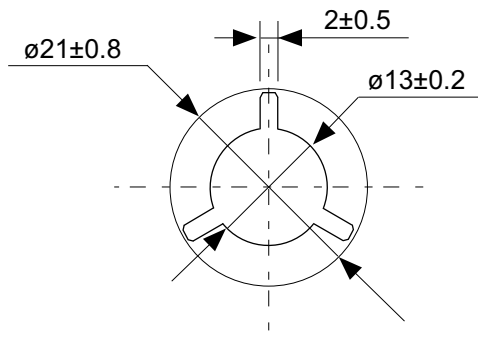

No. FH008A-R-SD-1.0

TITLE	HSOP8A-A-Reel		
No.	FH008-A-R-SD-1.0		
ANGLE		QTY.	4,000
UNIT	mm		
SII Semiconductor Corporation			

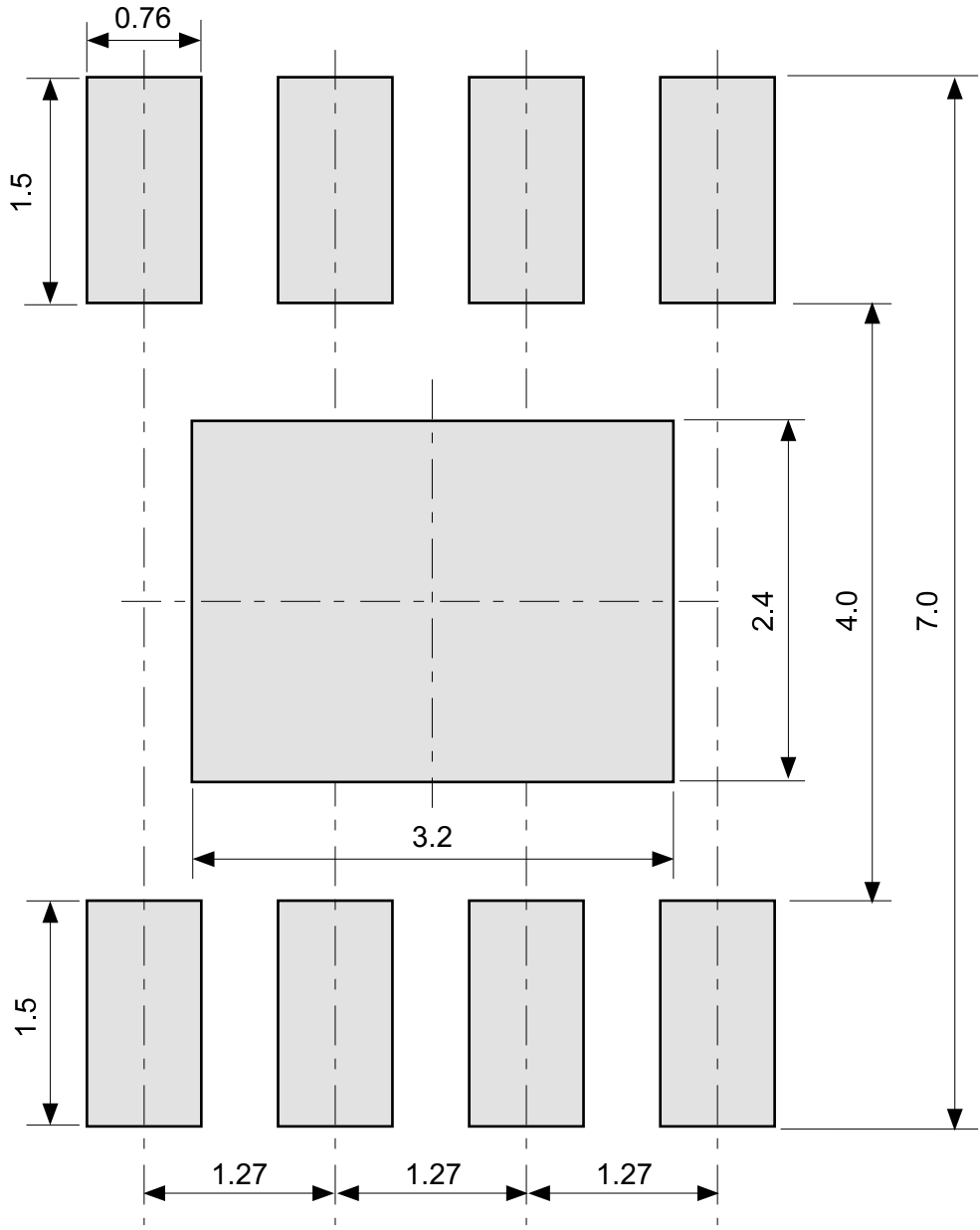

No. FH008-A-L-SD-1.0

TITLE	HSOP8A-A -Land Recommendation
No.	FH008-A-L-SD-1.0
ANGLE	
UNIT	mm
SII Semiconductor Corporation	

Disclaimers (Handling Precautions)

1. All the information described herein (product data, specifications, figures, tables, programs, algorithms and application circuit examples, etc.) is current as of publishing date of this document and is subject to change without notice.
2. The circuit examples and the usages described herein are for reference only, and do not guarantee the success of any specific mass-production design.
SII Semiconductor Corporation is not responsible for damages caused by the reasons other than the products or infringement of third-party intellectual property rights and any other rights due to the use of the information described herein.
3. SII Semiconductor Corporation is not responsible for damages caused by the incorrect information described herein.
4. Take care to use the products described herein within their specified ranges. Pay special attention to the absolute maximum ratings, operation voltage range and electrical characteristics, etc.
SII Semiconductor Corporation is not responsible for damages caused by failures and/or accidents, etc. that occur due to the use of products outside their specified ranges.
5. When using the products described herein, confirm their applications, and the laws and regulations of the region or country where they are used and verify suitability, safety and other factors for the intended use.
6. When exporting the products described herein, comply with the Foreign Exchange and Foreign Trade Act and all other export-related laws, and follow the required procedures.
7. The products described herein must not be used or provided (exported) for the purposes of the development of weapons of mass destruction or military use. SII Semiconductor Corporation is not responsible for any provision (export) to those whose purpose is to develop, manufacture, use or store nuclear, biological or chemical weapons, missiles, or other military use.
8. The products described herein are not designed to be used as part of any device or equipment that may affect the human body, human life, or assets (such as medical equipment, disaster prevention systems, security systems, combustion control systems, infrastructure control systems, vehicle equipment, traffic systems, in-vehicle equipment, aviation equipment, aerospace equipment, and nuclear-related equipment), excluding when specified for in-vehicle use or other uses. Do not use those products without the prior written permission of SII Semiconductor Corporation. Especially, the products described herein cannot be used for life support devices, devices implanted in the human body and devices that directly affect human life, etc.
Prior consultation with our sales office is required when considering the above uses.
SII Semiconductor Corporation is not responsible for damages caused by unauthorized or unspecified use of our products.
9. Semiconductor products may fail or malfunction with some probability.
The user of these products should therefore take responsibility to give thorough consideration to safety design including redundancy, fire spread prevention measures, and malfunction prevention to prevent accidents causing injury or death, fires and social damage, etc. that may ensue from the products' failure or malfunction.
The entire system must be sufficiently evaluated and applied on customer's own responsibility.
10. The products described herein are not designed to be radiation-proof. The necessary radiation measures should be taken in the product design by the customer depending on the intended use.
11. The products described herein do not affect human health under normal use. However, they contain chemical substances and heavy metals and should therefore not be put in the mouth. The fracture surfaces of wafers and chips may be sharp. Take care when handling these with the bare hands to prevent injuries, etc.
12. When disposing of the products described herein, comply with the laws and ordinances of the country or region where they are used.
13. The information described herein contains copyright information and know-how of SII Semiconductor Corporation.
The information described herein does not convey any license under any intellectual property rights or any other rights belonging to SII Semiconductor Corporation or a third party. Reproduction or copying of the information described herein for the purpose of disclosing it to a third-party without the express permission of SII Semiconductor Corporation is strictly prohibited.
14. For more details on the information described herein, contact our sales office.

1.0-2016.01

