

ABC1200 / ABE1200 Series

1200 W AC-DC Power Supplies

The ABC1200 / ABE1200 Series of AC-DC power supplies provide a steady 1200 W of regulated DC power through 180-305 VAC and 1000 W through 85-137 VAC input voltage ranges in a single output of 24 or 48 VDC, offering 12 and 5 VSB standby outputs and a full set of protection features.

The ABC1200 / ABE1200 Series is available in three compact 1U height compatible packages. One is enclosed with a built-in front mounted pair of fans and two (available only 24 V variant), U-shaped chassis with or without protective cover, to facilitate system integration.

The ABC1200 / ABE1200 Series supports digital power management over the Power Management Bus communications protocol. Multiple units may be connected in parallel for redundancy and / or higher power, enabled with the internal OR-ing and current sharing functions.

The ABC1200 / ABE1200 Series complies with the latest international safety standards and displays the CE-Mark for the European Low Voltage Directive (LVD).



Key Features & Benefits

- Universal input voltage range (85 – 305 VAC)
- Input inrush current limiting
- 1200 W rated power
- High efficiency up to 94%
- Single 24 VDC or 48 VDC output voltages available
- Active PFC, EN61000-3-2 compliant (Class C, >25% load)
- Low earth / touch leakage current
- Fan speed control function
- 800 LFM airflow for ABC1200 models
- Over temperature, OV, OC and SC protections
- +12 V, 0.5 A; +5 V, 1 A Stand by outputs
- Built-in current sharing and OR-ing for parallel operation and N+1 redundancy
- Remote On / Off signal
- Power good and remote sense signals
- Power Management Bus communication protocol supported
- Safety approvals to IEC/EN/UL 62368-1, IEC 60950-1
- LED lighting approval to UL 8750

Applications

- Video Wall Display, Entertainment Lighting
- LED Lighting Engine
- Industrial Control Systems
- Industrial Laser Applications



bel POWER SOLUTIONS & PROTECTION

a bel group

belfuse.com/power-solutions

1. MODEL SELECTION

| MODEL NUMBER | PACKAGE & COOLING | INPUT VOLTAGE RANGE [VAC] | NOM. OUTPUT VOLTAGE [VDC] | MAX. OUTPUT POWER [W] | MAX. OUTPUT CURRENT [A] | DIMENSIONS |
|------------------|-------------------------------------|---------------------------|---------------------------|-----------------------|-------------------------|--|
| ABC1200-1T24-UCF | U-chassis, external air flow | 85 - 305 | 24 | 1200 | 50 | 101.6 x 234.0 x 41.0 mm 4.00 x 9.21 x 1.61 in |
| ABC1200-1T24-PCF | Protective cover, external air flow | 85 - 305 | 24 | 1200 | 50 | 101.6 x 234.7 x 41.0 mm 4.00 x 9.24 x 1.61 in |
| ABE1200-1T24 | Enclosed, front mounted fan | 85 - 305 | 24 | 1200 | 50 | 101.6 x 264.1 x 41.0 mm 4.00 x 10.4 x 1.61 in |
| ABE1200-1T48 | Enclosed, front mounted fan | 85 - 305 | 48 | 1200 | 25 | 101.6 x 264.1 x 41.0 mm 4.00 x 10.4 x 1.61 in |

2. INPUT SPECIFICATIONS

| PARAMETER | DESCRIPTION / CONDITION | MIN | NOM | MAX | UNIT |
|---|---|----------------|-----------------|----------------------------|-----------------------|
| AC Input Voltage | PS starts at 85 V _{AC} at all load conditions Operating input voltage range ABC1200 / ABE1200 Series is designed to operate with a square or trapezoidal input voltage wave form (i.e. from UPS) | 85 | 100-277 | 305 | V _{RMS} |
| DC Input Voltage | Built in fuses safety certified up to 250 V _{DC} . Operating the 1200 Series above that limit up to 300 V _{DC} , does require an external fuse protection * | 120 | - | 300 | V _{DC} |
| Input Frequency | 400 Hz (max 440 Hz) operation over 85 – 137 V _{AC} input range | 47 | 50/60 | 63 | Hz |
| Input Current | At 180 V _{AC} , maximum load, 50 / 60 Hz At 85 V _{AC} , 1000 W load, 50 / 60 Hz 163 V _{DC} , maximum load 120 V _{DC} , 1000 W | - | - | 8.0 14.5 9.0 10.0 | A _{RMS} A |
| Inrush Current | At power-on asserted Cold start, 25 °C ambient, full load Any point of the AC input sine | - | - | 30 50 | A |
| Fusing | High breaking, 16 / 20 A, 277 V _{AC} (250 V _{DC}) on each AC line. | - | - | 16 / 20 | A |
| Efficiency | At 120 V _{AC} 20% rated load 50% rated load 100% rated load | 88 92 92 | - - - | - - - | % |
| Input Power Consumption | At 230 V _{AC} 20% rated load 50% rated load 100% rated load | 90 93 94 | - - - | - - - | W |
| Power Factor | At power on, no load, 100-277 V _{AC} range (ABE1200-1T24 / -1T48) At power on, no load, 100-277 V _{AC} range (ABC1200-1T24-UCF / -PCF) Stand by, no load, nominal 100-277 V _{AC} range | - - - | 7.0 6 4.0 | - - - | - |
| THDi | Any nominal input line voltage, 50/60 Hz, from 50 to 100% maximum load | 0.95 | - | - | - |
| Harmonic Current Fluctuations and Flicker | From 50 to 100% rated load, 100-277 V _{AC} , 50/60 Hz. | - | - | 20 | % |
| Earth Leakage Current | Complies with EN 61000-3-2 at 230 V _{AC} , 50/60 Hz, Class A, D. Complies with EN 61000-3-2 Class C at 230 V _{AC} , 50/60 Hz, >300 W load. Complies with EN 61000-3-3 at nominal voltages and full load. Normal conditions | - | 130 | - | μA |
| Touch Leakage Current | 115 V _{RMS} , 60 Hz 230 V _{RMS} , 50 Hz 264 V _{RMS} , 60 Hz (worst case) 264 V _{RMS} , 60 Hz | - - - | 240 - - | - - 400 | μA |
| | Normal Condition (NC) Single Fault Condition (SFC) | - - | - - | 100 500 | μA |

* Suggested fuse SIBA 5012434.16 and fuse holder SIBA 5105805.1

3. OUTPUT SPECIFICATIONS

| PARAMETER | DESCRIPTION / CONDITION | MIN | NOM | MAX | UNIT |
|--|---|--------------------|----------|--------------------------|-------------------------|
| V1 Output Voltages | ±0.5% set point accuracy RS+ closed on +V1, RS- closed on V1 RTN, at 6% load. | - | 24 48 | - | V |
| V1 Output Power Rating | 85 – 137 V _{AC} ABC1200-1T24-UCF / -PCF (800 LFM); (120-163 V _{DC}) ABE1200-1T24 / ABE1200-1T48 180 – 305 V _{AC} ABC1200-1T24-UCF / -PCF (800 LFM); (163-300 V _{DC}) ABE1200-1T24 / ABE1200-1T48 | | | 1000 1200 | W |
| V1 Output Current | 85 – 137 V _{AC} ABC1200-1T24-UCF / -PCF; ABE1200-1T24 (120-163 V _{DC}) ABE1200-1T48 180 – 305 V _{AC} ABC1200-1T24-UCF / -PCF; ABE1200-1T24 (163-300 V _{DC}) ABE1200-1T48 | | | 41.7 20.8 50 20 | A |
| V1 Voltage Adjustment Range | Manually by push up and down buttons | - | ±5 | - | %V1 |
| V1 Line Regulation | V _{AC} : 85 – 305 V _{RMS} | - | - | ±0.1 | %V1 |
| V1 Load-Line-Cross Regulation | V _{AC} : 85 – 305 V _{RMS} ; I ₁ : 0 – 100% | - | - | ±2 | %V1 |
| V1 Ripple and Noise | Rated load, Peak-to-peak, 20 MHz BW. (100 nF ceramic, 10 µF tantalum at load) | - | - | 1 | %V1 |
| Transient Response: V1, 12V _{SB} , 5V _{SB} Voltage Deviation | 25% load changes at 1 A/µs 24 V at 1000 µF load / I _{OUT} > 2.5 A 48 V at 560 µF load / I _{OUT} > 1.25 A 12 V _{SB} , 5 V _{SB} at 0-2200 µF load | - | - | ±5 | %V1 %V _{SB} |
| V1 Start-up Rise Time | 85 < V _{IN} < 305, any load conditions. At nominal V _{IN} , full load SEMI F47-0706 compliant at ≥208 V _{AC} | 10 10 | - | 150 | ms |
| V1 Hold-up Time | 50% sag (104 V) 30% sag (145 V) 20% sag (166 V) | 200 500 1000 | - | - | ms |
| V1 Current Sharing Accuracy | Parallel operation up to four units. Two units in parallel at I ₁ rated load. I-Share signals connected together. RS+, RS- signals connected together and to the load. Max load at start up 1200 W, operating 2000 W, 180 ÷ 305 V _{AC} . Max load at start up 1000 W, operating 1667 W, 85 ÷ 137 V _{AC} . | 40 | - | 60 | %I ₁ |
| V1 Remote Sense | RS+ and RS- power path voltage loss compensation | - | - | 0.36 | V |
| Start-up Delay | V1 in regulation after de-asserting PS_Inhibit V1 in regulation after AC is applied (worst case: 85 V _{AC}) 5V _{SB} in regulation after AC is applied (worst case: 85 V _{AC}) | - | - | 1700 2200 500 | ms |
| Turn-on Overshoot | | - | - | 10 10 | %V1 %V _{SB} |
| Minimum Load | V1, 12V _{SB} , 5V _{SB} | 0 | - | - | A |
| Maximum Load Capacitance | V1: 24 V _{DC} V1: 48 V _{DC} | - | - | 16000 8000 | µF |
| V1 Over Current Protection | V1: 24 V _{DC} V1: 48 V _{DC} | | | 75 37.5 | A |
| 12 V _{SB} Output Voltage | V _{SB} output voltage is referred to the same V1 output voltage return | - | 12 | - | V |
| 12 V _{SB} Output Current | All models up to 70 °C | - | - | 0.5 | A |
| 12 V _{SB} Ripple & Noise | Peak-to-peak | | | 120 | mV |
| 12 V _{SB} Line Cross Regulation | V _{AC} : 85 – 305 V _{RMS} ; I _{SB} : 0 – 100% | - | - | ±5 | %V _{SB} |
| 5 V _{SB} Output Voltage | V _{SB} output voltage is referred to the same V1 output voltage return | - | 5 | - | V |
| 5 V _{SB} Output Current | All models up to 70 °C | - | - | 1 | A |
| 5 V _{SB} Ripple & Noise | Peak-to-peak | | | 50 | mV |
| 5 V _{SB} Load, line cross Regulation | V _{AC} : 85 – 305 V _{RMS} ; I _{SB} : 0 – 100% | - | - | ±5 | %V _{SB} |

3.1 OUTPUT POWER DE-RATING CURVES

Front Fan (Models ABE1200-1T24 / ABE1200-1T48)
Any orientation, V1 nominal

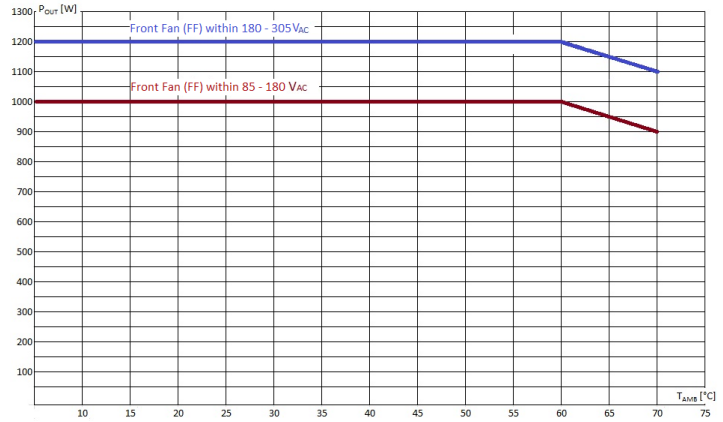
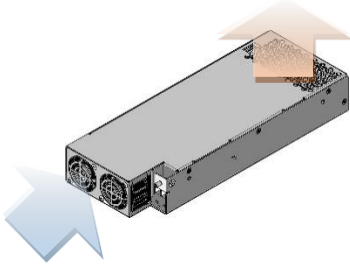

U-Chassis and Perforated Cover
Forced Air Cooling (Models ABC1200-1T24-UCF / -PCF)
Air flow from top, V1 nominal

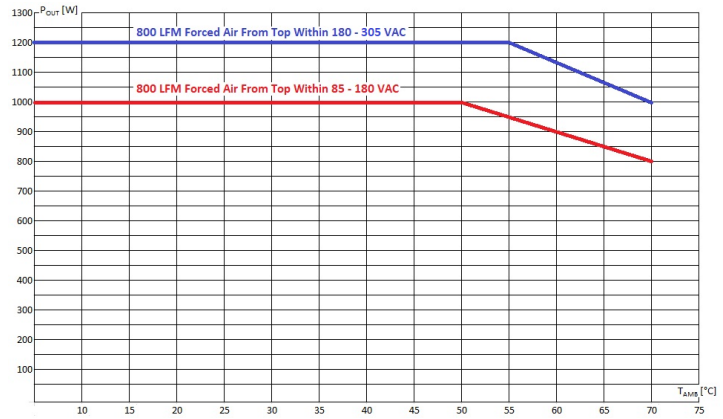
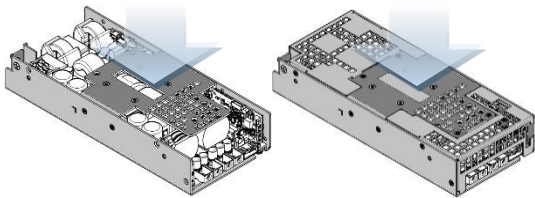

U-Chassis and Perforated Cover
Forced Air Cooling (Models ABC1200-1T24-UCF / -PCF)
Air flow from AC side, V1 nominal

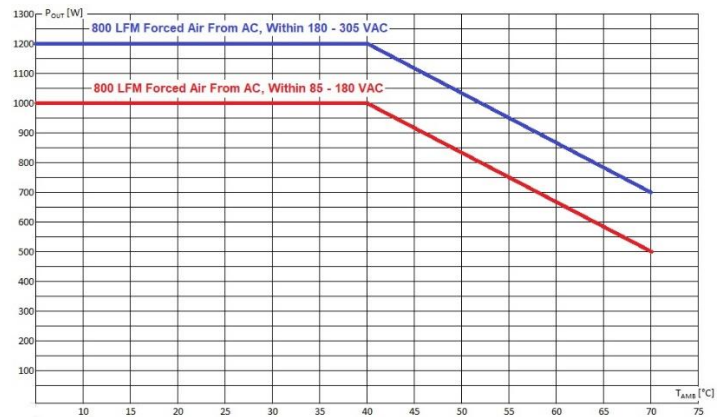
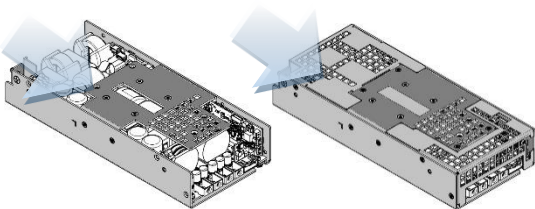

4. POWER MANAGEMENT BUS

The ABC1200 / ABE1200 Series does support communication according to the Power Management Bus 1.2 protocol via SDA, SCL and #SMBALERT signals as defined in the SMBus Specification version 2.0.

The power supply shall not load the SMBus if it has no input power (SCL & SDA lines should go to High-Z).

The pull-up resistors (2.2 kΩ) for these signals shall be external to the power supply and referenced to an external +3.3 V bus voltage.

The DSP circuits inside the power supply are powered by the standby output.

The Power Management Bus is active whatever input power is applied to the power supply or a parallel redundant power supply in the system, provided that their 12V_{SB} are connected in parallel.

Maximum speed of SMBus is 100 kHz.

The ADDR0 and ADDR1 signals, are inputs to the power supply that control the Power Management Bus address assigned to the power supply.

On the system side, the ADDR0 and ADDR1 signals will either be connected to return through a 1 kΩ pull-down resistor or connected to +3.3 V external bus voltage through a 1 kΩ pull-up resistor.

The address shall be derived from the logic of this pin as indicated on Outline Drawing and Connections section.

The power supply is a slave only on SMBus device.

For a comprehensive description of ABC1200 / ABE1200 Series Power Management Bus management, do refer to the application note, "ABC1200 / ABE1200 Series Power Management Bus Mgt". Examples of 1200 W Series parameters available through communication bus are:

- Input voltage status
- Output voltages +V1 measured value
- Output current on +V1 measured value
- Current sharing status
- Thermal health measured value
- Fan health status
- Power-On / Working hours
- Product information
- Status information

Failures shall be reported by Power Management Bus for all failure types:

- Fan fault
- Protections failure (OV, OC, OT)
- Voltages out of specification

5. SIGNALING & CONTROL SPECIFICATIONS

Base signals and controls are accessible from signal connector P204.

| SIGNAL | DESCRIPTION / CONDITION | MIN | NOM | MAX | UNIT |
|--------------------------------------|--|----------|--------|----------|------|
| +PS_Inhibit (Active High) | Input low voltage ($I_{IN}= 0 \mu A$) | 0 | - | 0.8 | V |
| | Input high voltage ($I_{IN}= 500 \mu A$ at 5.5 V) V1 disabled when PS_Inhibit is pulled high V1 enabled when PS_Inhibit is floating or low 5V _{SB} and 12V _{SB} not affected by PS_Inhibit | 2.5 | - | 5.5 | |
| -PS_Inhibit (Active Low) | Input low voltage ($I_{IN}= -800 \mu A$ at 0 V) | 0 | - | 0.8 | V |
| | Input high voltage ($I_{IN}= -200 \mu A$ at 2.5 V) ($I_{IN}= 700 \mu A$ at 5.5 V) V1 disabled when -PS_Inhibit is pulled low V1 enabled when -PS_Inhibit is floating or high 5V _{SB} and 12V _{SB} not affected by -PS_Inhibit | 2.5 | - | 5.5 | |
| Power_OK * (PS_OK) | Logic level low (<10 mA sinking) | - | - | 0.7 | V |
| | Logic level high (200 μA sourcing) | 2.4 | - | 3.45 | |
| | Low to high time after V1 in regulation Power down warning time | 150 2 | - - | 350 - | |
| I_Share | The I_SHARE signals shall be daisy chained among power supplies operating in parallel. On a single power supply operating it provides current measurement on V1 output. On multiple power supplies operating in parallel, it provides current measurement on master V1 output. | | | | |
| SDA, SCL, #SMBALERT, ADDR0, ADDR1 | These are signals which support Power Management Bus communication protocol as specified in the application note ABC1200 / ABE1200 Series Power Management Bus Mgt. | | | | |
| RSVD RX, RSVD TX | Mainly intended for internal use, these RX and TX signals - available at the output signal connector P204 - may be used to access some DSP functions (monitoring, threshold settings, debug functions). These signals work as an UART Rx/Tx port and can also work as a RS-232 Rx/Tx port by building in the "RS-232 LINE DRIVERS/RECEIVERS" IC | | | | |
| 5V _{SB} Output ** | Active and in regulation after an $85 < V_{AC} < 305$ is applied Not affected by PS_Inhibit. Available on P204, pin#4 | - | - | 500 | ms |
| 12V _{SB} Output *** | Active and in regulation after an $85 < V_{AC} < 305$ is applied Not affected by PS_Inhibit. Available on P204, pin#16 | - | - | 500 | ms |

* When V1 is On, a P_OK low may indicate V1 under voltage condition. When two 1200 W models operate in parallel, P_OK low in one unit indicates that it is not sharing the expected amount of current (current sharing fault). A 3.3 k Ω internal pull up to a 3.3 V internal reference voltage is used; do not add any other external pull up.

** The 5V_{SB} outputs of two or more 1200 W models operating in parallel, cannot be connected in parallel in turn, since doing so results in power supplies damage.

*** The 12V_{SB} outputs of two or more 1200 W models operating in parallel can be connected in parallel in turn, taking into account that the maximum available power will not be higher of a single operating power supply one.

5.1 BASE SIGNALS / CONTROLS TIMING

AC/DC INPUT OFF-TO-ON AND ON-TO-OFF TIMINGS

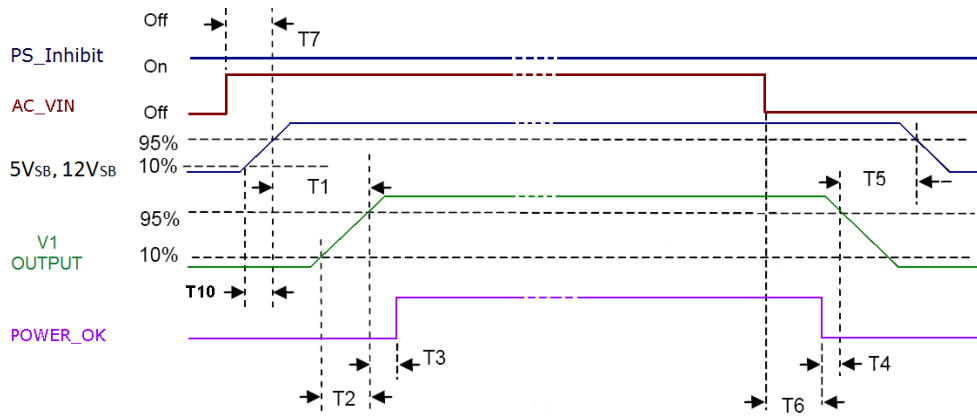

| | |
|---|-----------------------------|
| 12V _{SB} /5V _{SB} On to V1 On | 250 ms ≤ T1 ≤ 1700 ms |
| V1 rise time | 10 ms ≤ T2 ≤ 150 ms |
| 12V _{SB} /5V _{SB} rise time | 3 ms ≤ T10 ≤ 150 ms |
| V1 On – POWER_OK delay | 150 ms ≤ T3 ≤ 350 ms |
| Power down warning | T4 ≥ 2 ms |
| V1 Off to 12V _{SB} /5V _{SB} Off | T5 ≥ 0.5 s (V1 load > 25 W) |
| AC Off to POWER_OK low | T6 ≥ 8 ms |
| AC_On to 12V _{SB} /5V _{SB} On | T7 ≤ 500 ms |

PS_INHIBIT OFF-TO-ON AND ON-TO-OFF TIMINGS

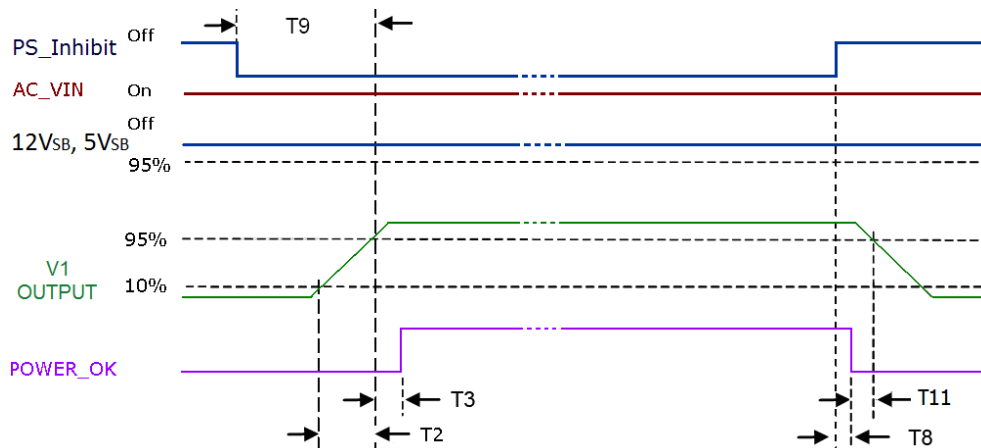

| | |
|---------------------------------|----------------------|
| V1 rise time | 10 ms ≤ T2 ≤ 150 ms |
| V1 On – POWER_OK delay | 150 ms ≤ T3 ≤ 350 ms |
| Turn-Off warning | T11 ≥ 1 ms |
| PS_Inhibit – POWER_OK low delay | T8 ≤ 3 ms |
| PS_Inhibit – V1 On delay | T9 ≤ 1700 ms |

6. PROTECTION SPECIFICATIONS

| PARAMETER | DESCRIPTION / CONDITION | MIN | NOM | MAX | UNIT |
|--------------------------------------|---|------|-----|-------|---------------------|
| Input Under Voltage | Auto-recovering, hiccup mode. | 58 | 75 | 82 | V _{AC} |
| Input Fuse | High breaking, 16 / 20 A, 277 V _{AC} (250 V _{DC}) on each AC lines. | - | - | 16/20 | A |
| Over Current | At nominal input voltages | | | | |
| | V1: Hiccup mode, auto-recovering | - | - | 150 | %I _{Rated} |
| | 5V _{SB} : Auto-recovering | - | - | - | A |
| | 12V _{SB} : Hiccup mode, auto-recovering | - | - | - | A |
| Short Circuit | See Output Ratings Table section | | | | |
| | At nominal input voltages | | | | |
| | V1: Hiccup mode or latch | - | - | - | |
| | 5V _{SB} : Auto-recovering | - | - | - | |
| Over Voltage | 12V _{SB} : Hiccup mode, auto-recovering. | 116 | - | 145 | %V _{NOM} |
| | V1, Power shut down, latch off. | - | - | 150 | |
| Over Temperature (ambient) | Hiccup mode, auto-recovering. | 70 | - | - | °C |
| Over Temperature (on secondary side) | Hiccup mode, auto-recovering. | - | - | - | °C |
| Fan Fault Protection | Relevant to the ABE1200-1T24 / ABE1200-1T48 models. The DSP monitors the signals (frequency generator) provided by both fans. If one fan fails, the DSP asserts maximum speed the other fan and provides an alarm indication through Power Management Bus. If both fans fail, the DSP provides an alarm indication through LED and through Power Management Bus and after 20 s, does shut down V1. PS INHIBIT or AC/DC input have to be cycled to resume operations, after removed the fault. | | | | |
| Isolation: Primary-to-Secondary | Reinforced | 5660 | - | - | V _{DC} |
| | | 4000 | - | - | V _{AC} |
| Isolation: Input-to-Earth | Basic Production tested at 2642 V _{DC} | 2642 | - | - | V _{DC} |
| | | 1865 | - | - | V _{AC} |
| Isolation: Output-to-Earth | Basic | 1500 | - | - | V _{AC} |
| Equipment Protection Class | Class I | | | | |

7. ENVIRONMENTAL SPECIFICATIONS

| PARAMETER | DESCRIPTION / CONDITION | MIN | NOM | MAX | UNIT |
|---|---|--------|-----|------|-------|
| Operating Temperature Range | No derating up to 60 °C (ABE1200) and up to 55 °C (ABC1200) | -20 | - | 60 | °C |
| | See derating curves above 1200 W starts at -40 °C upon warm up delay | | | | |
| Operating Temperature Range with Derating | See derating curves and conditions in the Output Specifications section | - | - | 70 | °C |
| Storage Temperature | As per IEC/EN 60721-3-1 Class 1K4 | | | | |
| Transportation Temperature | As per IEC/EN 60721-3-2 Class 2K4 | -40 | - | 85 | °C |
| Humidity | RH, Non-condensing Operating. | - | - | 90 | % |
| | Non-operating | - | - | 95 | % |
| Operating Altitude | Power derating above 1800 m | - | - | 5000 | m |
| Shock | EN 60068-2-27 | | | | |
| | Operating: Half sine, 30 g, 18 ms, 3 axes, 6x each (3 positive and 3 negative). | | | | |
| | Non-Operating: Half sine, 50 g, 11 ms, 3 axes, 6x each (3 positive and 3 negative). | | | | |
| Vibration | EN 60068-2-64 | | | | |
| | Operating: Sine, 10 – 500 Hz, 1 g, 3 axes, 1 oct/min., 60 min. | | | | |
| | Random, 5 – 500 Hz, 0.02 g ² /Hz, 1 g _{RMS} , 3 axes, 30 min. | | | | |
| MTBF | Non-Operating: 5 – 500 Hz, 2.46 g _{RMS} (0.0122 g ² /Hz), 3 axes, 30 min. | | | | |
| | Full load, 25 °C ambient, 100% duty cycle, | 700000 | - | - | Hours |
| Useful Life | Full load, 40 °C ambient, 75% duty cycle | 600000 | - | - | Hours |
| | Telcordia SR-332 Issue 2 | | | | |
| Useful Life | Nominal V _{IN} , 80% load, 40 °C ambient (IPC9592) | - | 7 | - | Years |

8. ELECTROMAGNETIC COMPATIBILITY (EMC) – EMISSIONS

| PARAMETER | DESCRIPTION / CONDITION | STANDARD | PERFORMANCE CLASS |
|------------------------------------|--|---|-------------------|
| Conducted | 115, 230, 277 V _{RMS} , Maximum load | EN 55032 EN 55011 (ISM) FCC Part 15 | B |
| Radiated | | EN 55032 EN 55011 (ISM) FCC Part 15 | B * |
| Line Voltage Fluctuation & Flicker | At 20%, 50% and 100% maximum load Nominal input voltages | EN 61000-3-3 | |
| Harmonic Current Emission | 230 VAC input voltage, 50 / 60 Hz 230 VAC 50 / 60 Hz, >300 W load | EN 61000-3-2 EN 61000-3-2 | A, D C |

* Performance referred to the enclosed package with additional HF chokes on input, output power and signal cables. Radiated emission relevant to the UCF and PCF package variants, should be assessed at system level.

9. ELECTROMAGNETIC COMPATIBILITY (EMC) – IMMUNITY

| PARAMETER | DESCRIPTION / CONDITION | STANDARD | TEST LEVEL | CRITERIA |
|-------------------------|--|---|--|---|
| | Reference standard for ITE | EN 55024 | | |
| | Reference standard for Industrial/IMS equipment | EN 61000-6-2 | | |
| ESD | 15 kV air discharge, 8 kV contact, at any point of the system. | EN 61000-4-2 | 4 | A |
| Radiated Field | 10 V/m, 20-2700 MHz, 1 KHz, 80% AM. | EN 61000-4-3 | 3 | A |
| Electric Fast Transient | ±2 kV on AC power port for 1 minute | EN 61000-4-4 | 3 | A |
| Surge | ±2 kV line to line; ± 4 kV line to earth on AC power port | EN 61000-4-5 | 4 | A |
| Conducted RF Immunity | 10 V _{RMS} , 0,15-80 MHz, 1 kHz, 80% AM | EN 61000-4-6 | 3 | A |
| Dips and Interruptions | 200 – 277 V _{AC} : | Drop-out to 0% for 10 ms Dip to 40% for 5 cycles (100 ms) Dip to 70% for 25 cycles (500 ms) Drop-out to 0% for 5 s | EN61000-4-11 EN61000-4-11 EN61000-4-11 EN61000-4-11 | A* A (derate to 900 W) A B |
| | 100 – 127 V _{AC} : | Drop-out to 0% for 10 ms Dip to 40% for 5 cycles (100 ms) Dip to 70% for 25 cycles (500 ms) Drop-out to 0% for 5 s | EN 61000-4-11 EN 61000-4-11 EN 61000-4-11 EN 61000-4-11 | A* A (derate to 400 W) A (derate to 700 W) B |

* Performance referred to +5VSB, +12VSB and V1 (PS_OK goes to low level after 8 ms as per timing described at page 8)

10. SAFETY AGENCIES APPROVALS

| CERTIFICATION BODY | SAFETY STANDARDS | CATEGORY |
|--|---|--|
| CSA / UL | CSA C22.2 No. 60950-1, UL 60950-1, UL 62368-1; UL8750, CSA22.2 No. 250.13 | Audio Video and Information Technology Equipment |
| IEC IECCE CB Certification | IEC/EN 60950-1, IEC/EN 62368-1 | LED Lighting Audio Video and Information Technology Equipment |
| CE | Directive 2014/35/EU: Electrical Safety: Low Voltage electrical equipment (LVD) Directive 2014/30/EU: Electromagnetic Compatibility (EMC) Directive 2015/863/EU: RoHS 3 | Audio Video and Information Technology Equipment |
| Meets all essential requirements of the standard IEC/EN/UL/CSA 61010-1 2nd edition | | |



Asia-Pacific
+86 755 298 85888

Europe, Middle East
+353 61 225 977

North America
+1 408 785 5200

11. CONNECTIONS AND PIN DESCRIPTION

| CONNECTIONS | CONNECTOR | REFERENCE | FUNCTION |
|-------------------------------------|--|---|---------------------------------------|
| AC Input Connections | P1: AMTEK TB25C-B02P-13-00A-L M4 GROUND STUD | 1 | Line 1 |
| | | 2 | Line 2 |
| | | 3 | Protection Earth |
| DC Input Connections | P200, P201, P202, P203: BRASS M4 THREADED TERMINALS (tight to 0.8 – 1 Nm, max. deep screws 7 mm) | | 24 V Optional 24 / 48 V |
| | | P200 | +V1 +V1 |
| | | P201 | +V1 - |
| | | P202 | V1 RTN V1 RTN |
| | | P203 | V1 RTN - |
| Signal Connector | P204: MOLEX 501876-1640 | 1 | RMT (-) |
| | | 2 | RMT (+) |
| | | 3 | I-SHARE |
| | | 4 | +5V _{SB} |
| | | 5 | PS_INHIBIT |
| | | 6 | PS_OK |
| | | 7 | SCL |
| | | 8 | SDA |
| | | 9 | #SMBALERT |
| | | 10 | ADDR0 |
| | | 11 | -PS_INHIBIT |
| | | 12 | ADDR1 |
| | | 13 | RSVD_RX (OUT) |
| | | 14 | RSVD_TX (OUT) |
| | | 15 | RTN |
| | | 16 | +12V _{SB} |
| Additional Control Functions | SW600 | V1_ADJ (UP) | |
| | SW601 | V1_ADJ (DOWN) | |
| | DL600 | Bi-colour LED | |
| | Off | No AC/DC input power provided | |
| | Blinking Green | Input power good, standby active, V1 inhibited | |
| | Steady Green | V1 Active | |
| | Steady or Blinking red | Power Supply Fault | |

12. MECHANICAL SPECIFICATIONS

| PARAMETER | DESCRIPTION / CONDITION |
|--------------------|---|
| Weight | 1150 g (2.53 lb) – ABC1200-1T24-UCF |
| | 1250 g (2.75 lb) – ABC1200-1T24-PCF |
| | 1550 g (3.42 lb) – ABE1200-1T24 / ABE1200-1T48 |
| Overall Dimensions | 101.6 x 234.0 x 41.0 mm (4.00 x 9.21 x 1.61 in) – ABC1200-1T24-UCF |
| | 101.6 x 234.7 x 41.0 mm (4.00 x 9.24 x 1.61 in) – ABC1200-1T24-PCF |
| | 101.6 X 264.1 x 41.0 mm (4.00 x 10.4 x 1.61 in) – ABE1200-1T24 / ABE1200-1T48 |

12.1 OUTLINE DRAWING & CONNECTIONS – U-CHASSIS FORCED AIR COOLING (ABC1200-1T24-UCF)

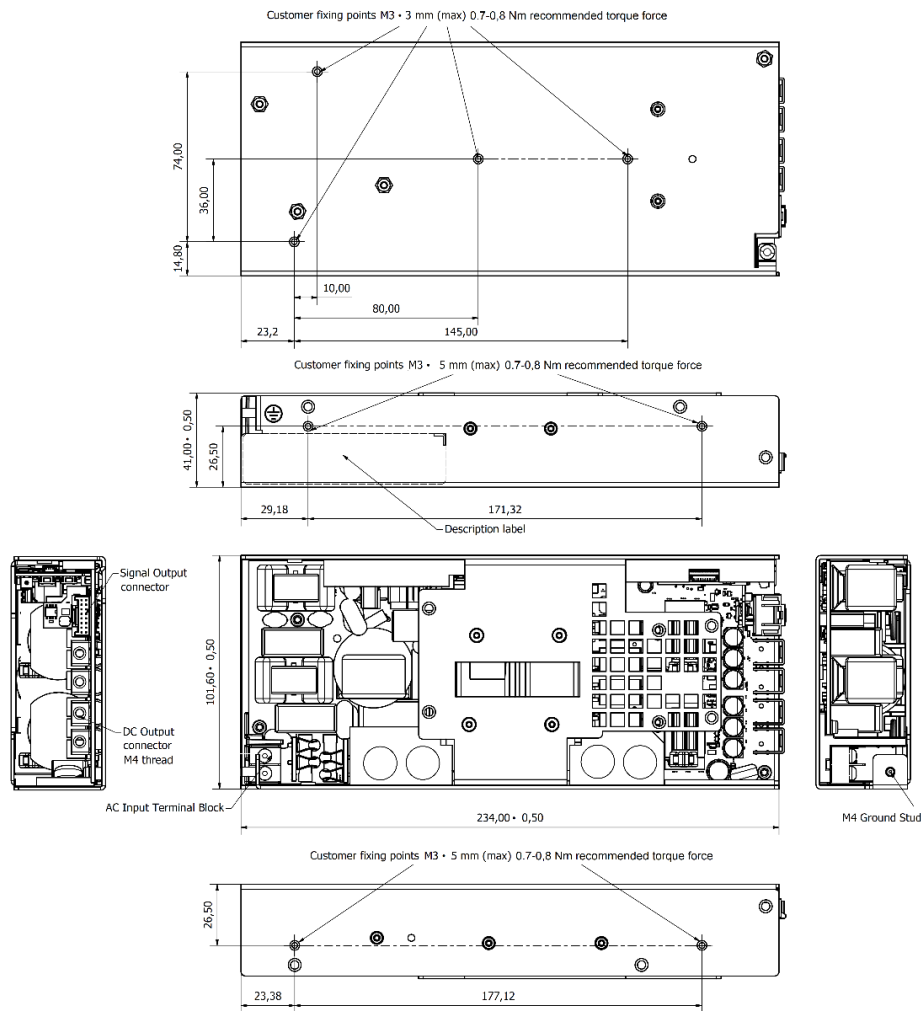

Figure 1. Mechanical Drawing - ABC1200-1T24-UCF Model

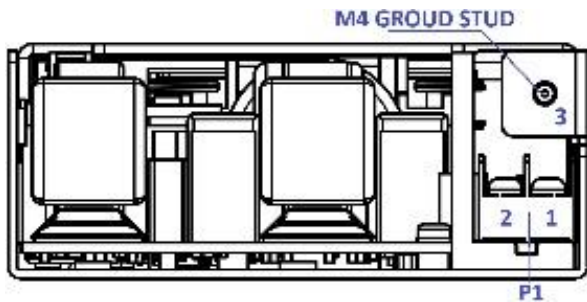

Figure 2. Front View - ABC1200-1T24-UCF Model

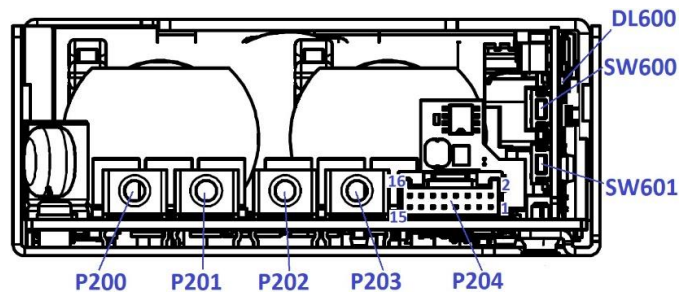

Figure 6. Rear View - ABC1200-1T24-UCF Model

12.2 OUTLINE DRAWING & CONNECTIONS – PERFORATED COVER FORCED AIR COOLING (ABC1200-1T24-PCF)

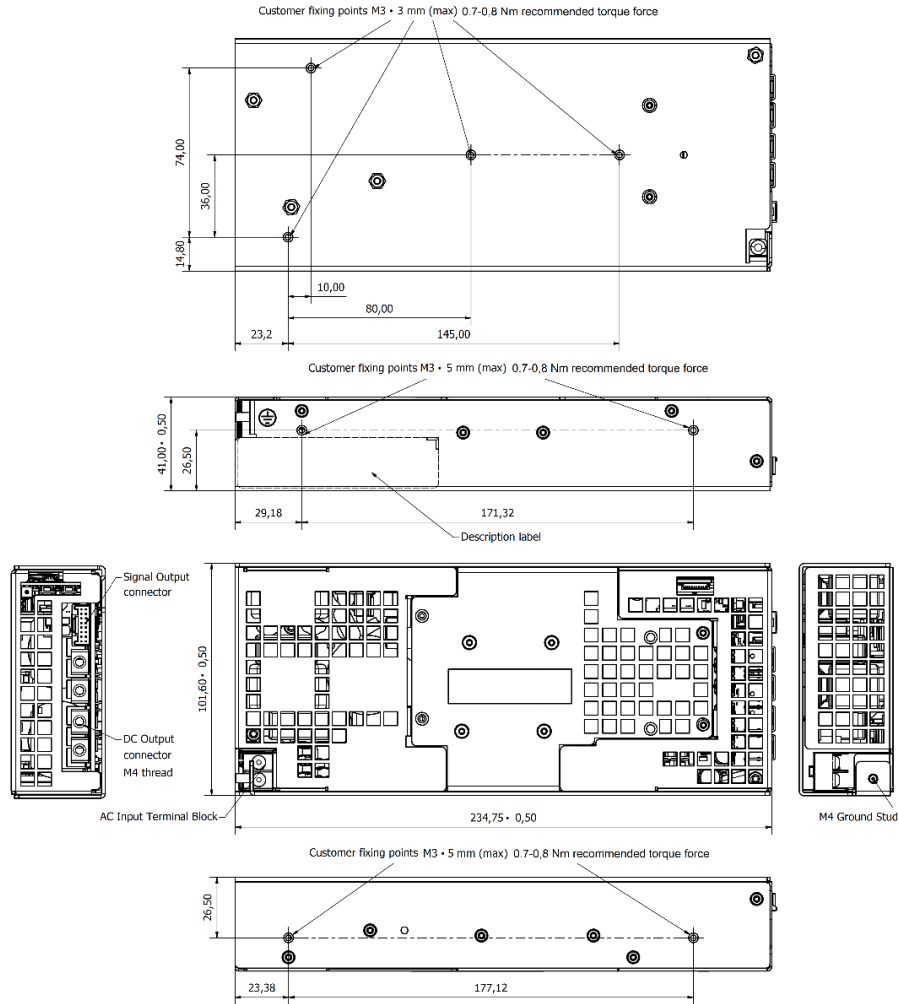

Figure 4. Mechanical Drawing - ABC1200-1T24-PCF Model

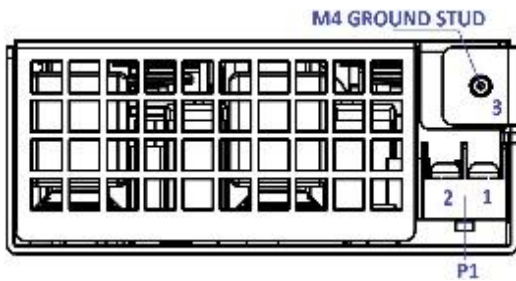

Figure 5. Front View - ABC1200-1T24-PCF Model

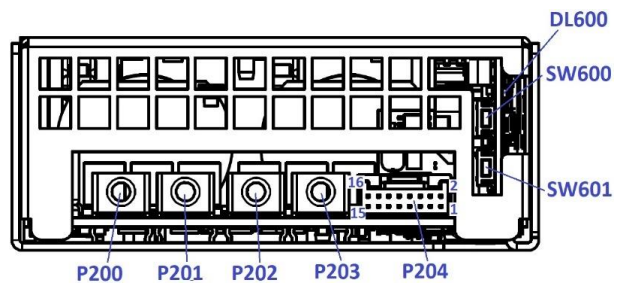

Figure 6. Rear View - ABC1200-1T24-PCF Model

12.3 OUTLINE DRAWING & CONNECTIONS – FRONT MOUNTED FAN (ABE1200-1T24 / ABE1200-1T48)

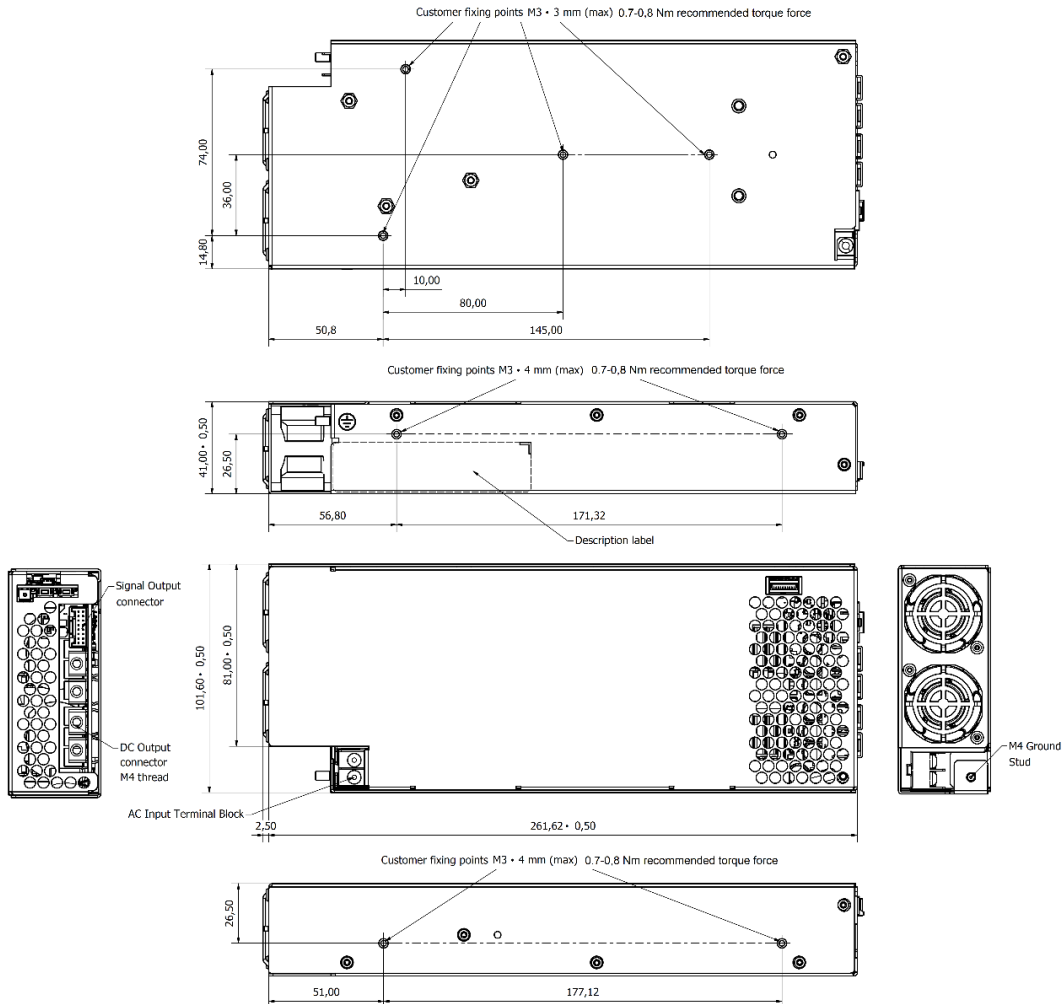

Figure 7. Mechanical Drawing - ABE1200-1T24 / ABE1200-1T48 Models

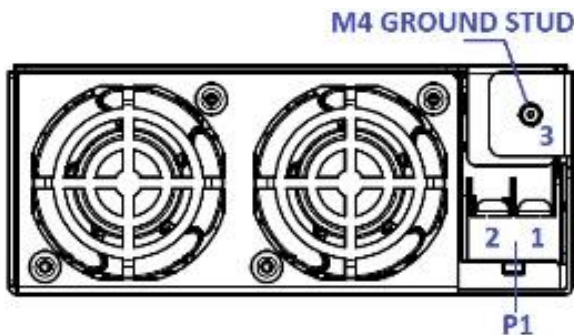

Figure 8. Front View - ABE1200-1T24 / ABE1200-1T48 Models

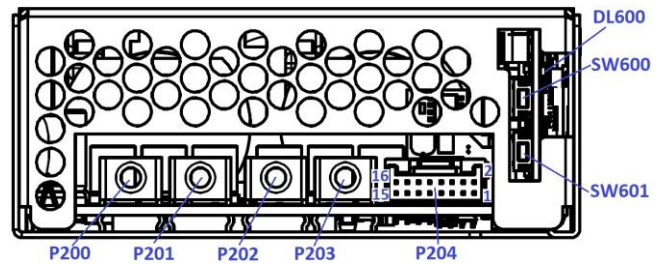
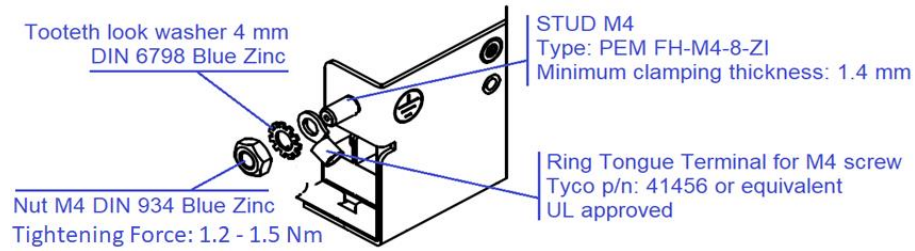

Figure 9. Rear View - ABE1200-1T24 / ABE1200-1T48 Models

12.4 PROTECTION EARTH CONNECTION INSTRUCTIONS



For more information on these products consult: tech.support@psbel.com

NUCLEAR AND MEDICAL APPLICATIONS - Products are not designed or intended for use as critical components in life support systems, equipment used in hazardous environments, or nuclear control systems.

TECHNICAL REVISIONS - The appearance of products, including safety agency certifications pictured on labels, may change depending on the date manufactured. Specifications are subject to change without notice.