

# STANDARD

## Resistive Touch Panel Specification

### FID-550 7-Wire Series

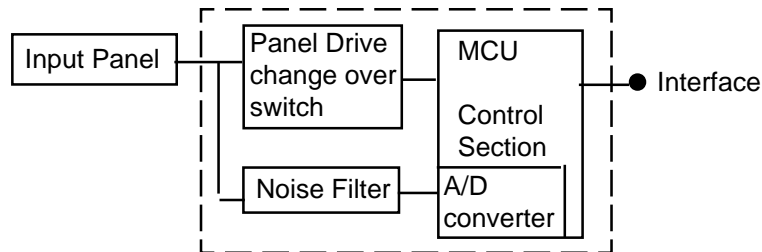

#### ■ FEATURES

- Superior long life, using a unique construction method offering improved life over typical technologies; by sensing data input only on the glass layer, typically a 10x improvement in product life is achieved.
- Excellent specification and high quality
  - Anti-Newton ring technology
  - High reliability materials
- Pen/Finger, Pen Only, Finger Only, Light Touch types available
- Transparency 80% - typical

#### ■ PART NUMBERS

Touch Panels:

Part Number	Size	Type
N010-0510-T302	17"	Pen/Finger
N010-0510-T211	15"	Pen/Finger
N010-0550-T913	13.3"	Pen/Finger
N010-0550-T711	12.1"	Pen/Finger
N010-0551-T242	12.1"	Pen/Finger (light touch type)
N010-0550-T811	11.3"	Pen/Finger
N010-0550-T601	10.4"	Pen only
N010-0550-T611	10.4"	Pen/Finger
N010-0550-T621	10.4"	Pen/Finger (light touch type)
N010-0550-T511	9.5"	Pen/Finger
N010-0550-T341	8.4"	Pen/Finger

#### ■ PART NUMBERS

Controller Boards:

Part Number	Type
N16B-0558-B240	7-Wire, RS232
N16B-0558-B720	7-Wire, USB

#### ■ PART NUMBERS

Interface Controller Chips:

Part Number	Type
N010-0559-V022	7-Wire, RS232
NC41120-0015	7-Wire, USB

## ■ DIMENSION EXAMPLE (10.4" SHOWN)

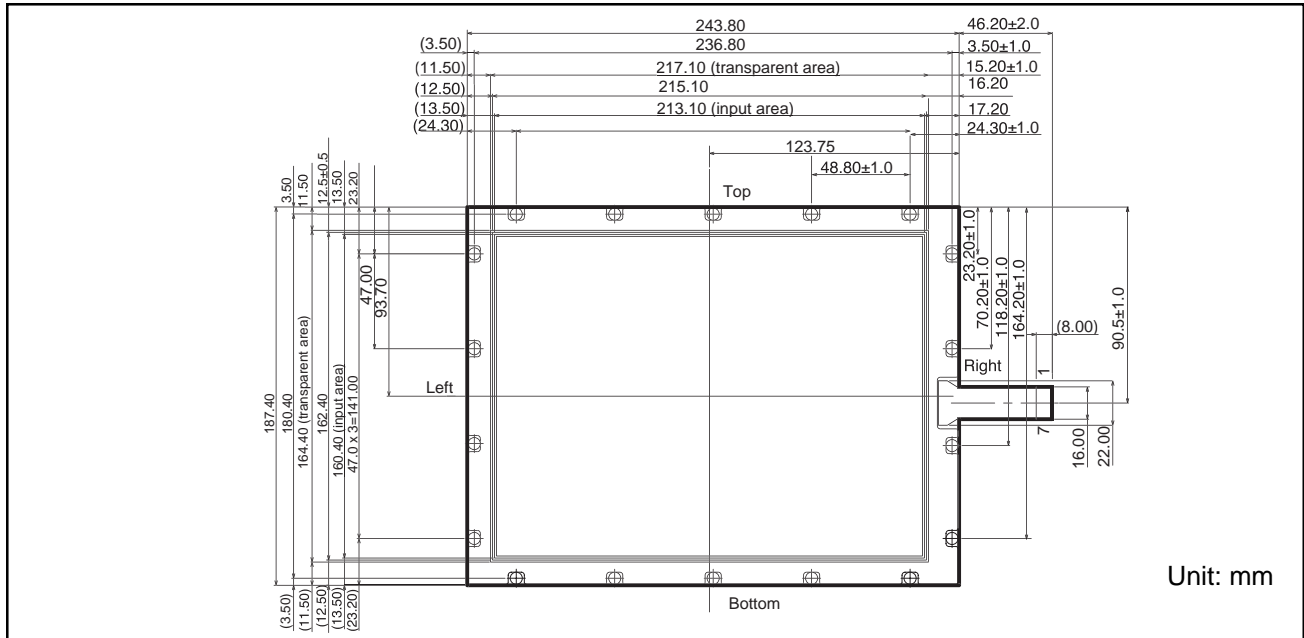

## ■ DETAILED SPECIFICATION

### ■ 1.0 APPLICATION

This specification applies to the 10.4" (inch) standard Touch Panel (Pen/Finger type). P/N is N010-0550-T611.

### ■ 2.0 ADDITIONAL APPLICATIONS

Control IC specifications and Control PCB, complete Touch Panel Specifications are also applicable.

### ■ 3.0 DISCRPTION AND BLOCK DIAGRAM

This panel in combination with a control IC chip is used to transfer the co-ordinates of the touched position to the host system (see block diagram above).

### ■ 4.0 DRAWING (Please see the diagram above.)

Definitions of the major dimensions indicated on this diagram:

- Effective Input Area (A)** Area guaranteed to meet all the characteristics detailed in this specification
- View / Transparent Area (B)** The area inside the adhesive zone or electrode pattern.
- Anti-input Area (C)** An insulating area allowed to protect the touch panel from giving false readings when an enclosure touches the panel.

## ■ 5.0 CHARACTERISTICS

### ■ 5.1 MECHANICAL

- Operating Force** 0.05~0.49 N (5 ~ 50gF) Measured with a Silicon Measurement Rod R 8 (Round type 8mm) Silicon Rubber Hardness 60°C
- Hardness of Surface** Pencil hardness 3H minimum against specification JIS K-5400

### ■ 5.2 OPTICAL

- Transparency** 78% min measured in the effective input area to JIS K 7105 using a MURAKAMI SHIKISAI KENKYUSHO type IIR 100 meter. Typically 80%.
- Haze** 5% measured in the effective input area using a MURAKAMI SHIKISAI KENKYUSHO type IIR 100 meter with an Anti Glare treated surface.

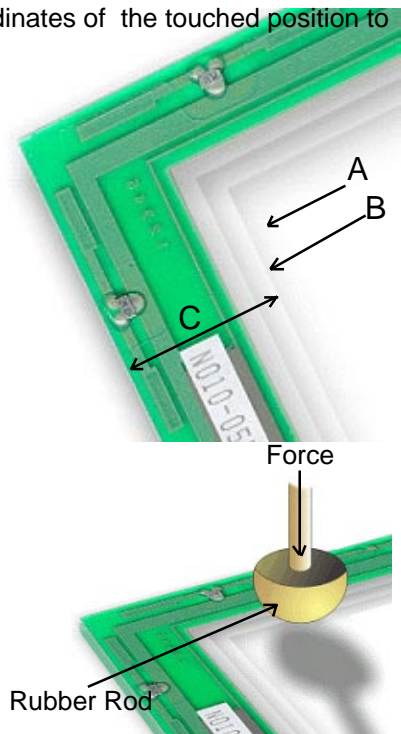

## 5.3 ELECTRICAL

<b>Location Accuracy:</b>	±2.5mm Measured over 9 points (See note 1)
<b>Linearity:</b>	1.5%
<b>Current Consumption:</b>	20mA max at DC 5V when applying 5VDC between pins 3 & 5
<b>Switch Bounce (Chattering):</b>	10ms min when using the silicon rubber measurement rod.
<b>Insulation resistance:</b>	10MΩ minimum at 25KV DC applied between pins 3 & 7 or between 5 and 7
<b>Dielectric Strength:</b>	25KV DC for 1 minute

*Note 1:*

Measurement condition of linearity is corrected within the control IC. In general the location accuracy is specified as follows:

**Actual co-ordinate point - theoretical co-ordinate point = location accuracy.**

In general a 9 point co-ordinate calibration system is used to adjust the micro controller accuracy. (20 point can be used in combination with an EEPROM design).

*Note 2:*

Pins 3, 5 and 7 are the glass and film connection points.

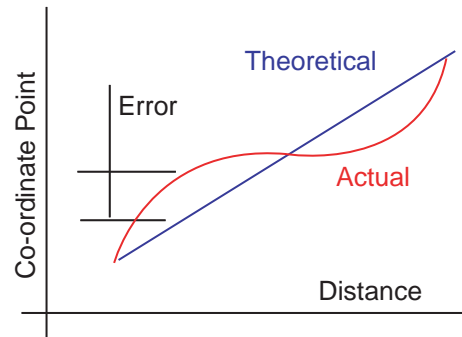

## 5.4 ENVIRONMENTAL

<b>Operating Temperature (*):</b>	-5°C to 60°C
<b>Storage Temperature:</b>	-30°C to 70°C
<b>Operating Humidity:</b>	20% to 90% RH with a Maximum wet bulb temperature of 38°C
<b>Storage Humidity:</b>	10% ~ 90% RH with a Maximum wet bulb temperature of 38°C
<b>Chemical Resistance:</b>	Coating with the following chemicals and storing at room temperature for 2 hours gives no problems. 10% NaCl-water solution, ethyl-acetate, ethyl-alcohol, toluene, methyl-ethyl-ketone.

## 5.5 PEN LIFE

<b>Character Writing life:</b>	1,000,000 words minimum
<b>Touch Input life :</b>	10,000,000 times minimum

*Note 1:*

Words are written in the notes area and the size of the word is 7.5mm x 6.75mm. A word is any Alphabet / Number / Mark. The pen is as shown below and applies a force of 250g. A failure is judged to happen when the current consumption or insulation resistance or dielectric strength are not met as shown in 5.3. The location accuracy with 9 point calibration must be ±4.4 mm max.

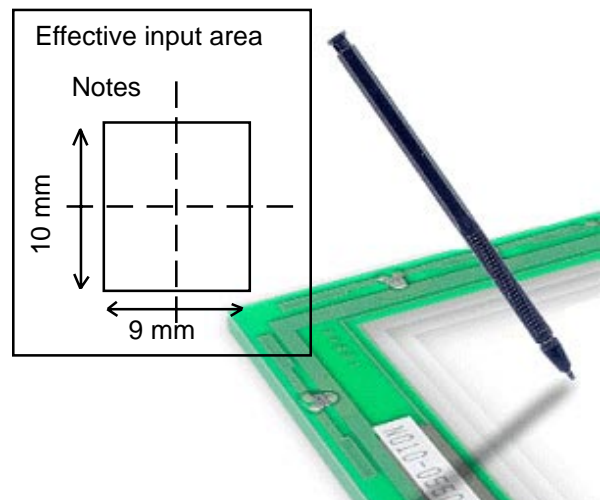
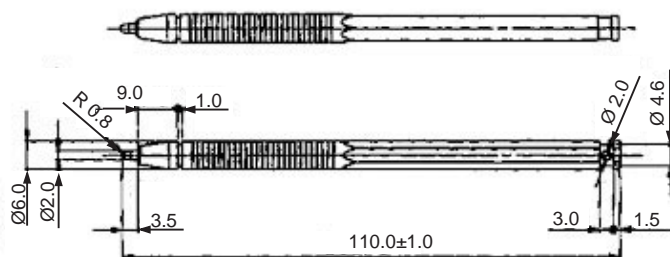

## ■ 5.6 FINGER LIFE



A finger is simulated by a silicon rubber plunger R8 (Round type 8mm size) hardness 60°C at 200g at frequency 5Hz.

A failure is judged to happen when the current consumption or insulation resistance or dielectric strength are not met as shown in 5.3. The location accuracy with 9 point calibration must be  $\pm 4.4$  mm max. Typical operating force is 150g max.

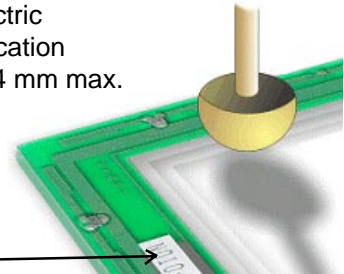

## ■ 5.7 INFORMATION ON THE PANEL

The panel part number is visible from the film side  
The production information is visible from the glass side.  
Production year 99 00 etc.

1 2 3 4 5 6 7 8 9 X Y Z or 1 2 3 4 5 6 7 8 9 X Y Z

January Production

□ 2 3 4 5 6 7 8 9 X Y Z or ○ 2 3 4 5 6 7 8 9 X Y Z

February Production

□ □ □ □ □ □ □ □ □ □ □ Z or 1 2 3 4 5 6 7 8 9 ○ Y Z

December Production

## ■ 6 PACKAGING

### ■ 6.1 PACKING SPECIFICATION

Vibration: 10~55 Hz at 1 Octave per minute 10G 20 cycles with one side 0.75mm  
Drop test: 60cm Drop 1 corner, 3 crease lines and 6 faces. 1 each 1 time  
After the test no glass: flaw or crack is seen, and no dent or scratch on the film.  
Also glass and film must not separate.

### ■ 6.1 PACKING DETAILS

Each touch panel is placed into a plastic bag and is held in place by a slit cut into the side of the cardboard. A second insertion piece is placed into the carton to again add stability. The qty is written on the side of the box. For example the T611 has 26 pieces per box.

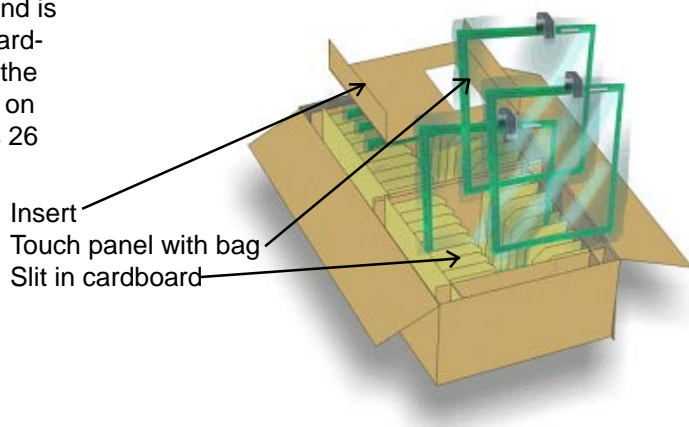

■ **7.0 REJECT CRITERIA**

Description		Reject Criteria	
Film Dent		Area $\geq 0.1\text{mm}^2$ Area $\geq 0.05\text{mm}^2$ & area $< 0.1\text{mm}^2$ Area $< 0.05\text{mm}^2$	: to be zero : to be max. 5 points : none specified
Foreign material between glass and film	Dot type	Area $> 0.1\text{mm}^2$ Area $\geq 0.05\text{mm}^2$ & area $< 0.1\text{mm}^2$ Area $< 0.05\text{mm}^2$	: to be zero : to be max. 5 points : none specified
	Line type	Area $\geq 0.1\text{mm}$ Area $\geq 0.03\text{mm}$ & width $< 0.1\text{mm}$ and length $< 10\text{mm}$ Area $< 0.05\text{mm}$	: to be zero : to be max. 1 point : none specified
Scratch		Area $\geq 0.1\text{mm}$ Area $\geq 0.03\text{mm}$ & width $< 0.1\text{mm}$ with length $< 80\text{mm}$ Area $< 0.03\text{mm}$ & width $< 0.1\text{mm}$ with length $< 30\text{mm}$	: to be zero : to be max. 1 point : none specified
Dot blur or hard coat missing		Area $\geq 0.5\text{mm}^2$ Area $\geq 0.03\text{mm}^2$ & area $< 0.5\text{mm}^2$ Area $< 0.05\text{mm}^2$	: to be zero : to be max. 5 points : none specified
Newton Ring		These must not be seen from Panel film side under a fluorescent lamp (3 wavelength type lamp). Not to be verified from glass side.	
Glass flaw		To be no flaw which is bigger than that shown in the following diagram. The number of flaws is not specified.	

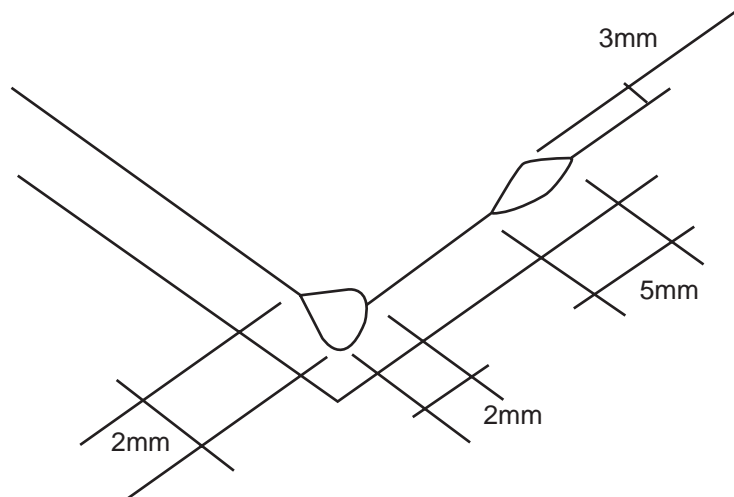

■ **8.0 GENERAL POINTS OF CAUTION**

Touch panels are made of glass, so care must be taken in handling them. Do not stress, pile, bend, lift by the cable or put any stress on the film, for example moving by film face vacuum. In order to clean wring dry a cloth which has been emersed in a natural detergent. DO NOT use any organic solvent, acid or alkali solution. Watch the edge of the panel when cleaning, again for safety reasons.

## 9.0 CONNECTION AND MOUNTING

The details below indicate the recommended mounting structure for panel and enclosure. The enclosure support to fix the touch panel must be over 1.0mm l width and must be outside the view (Transparent area). Also ensure that the enclosure does not cause miss input by touching the view area.

The following diagram shows that the enclosure edge must be between the View area and the guaranteed active area. Ensure space is allocated for the diodes, and we recommend that the material to fix the panel and enclosure is elastic. Special design would be required to stop water ingress. The corners of the touch panel are conductive so do not touch any metal parts after mounting.

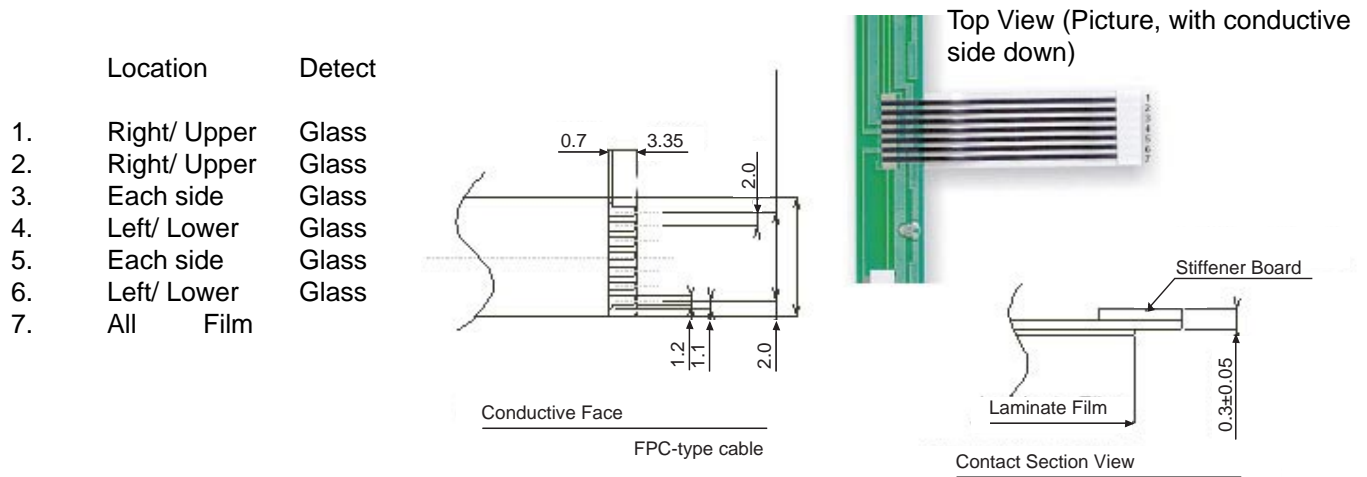

Bottom View (Drawing, with conductive side up)

(Mating connector type FCI or equivalent SFW15R-1ST: for FPC)

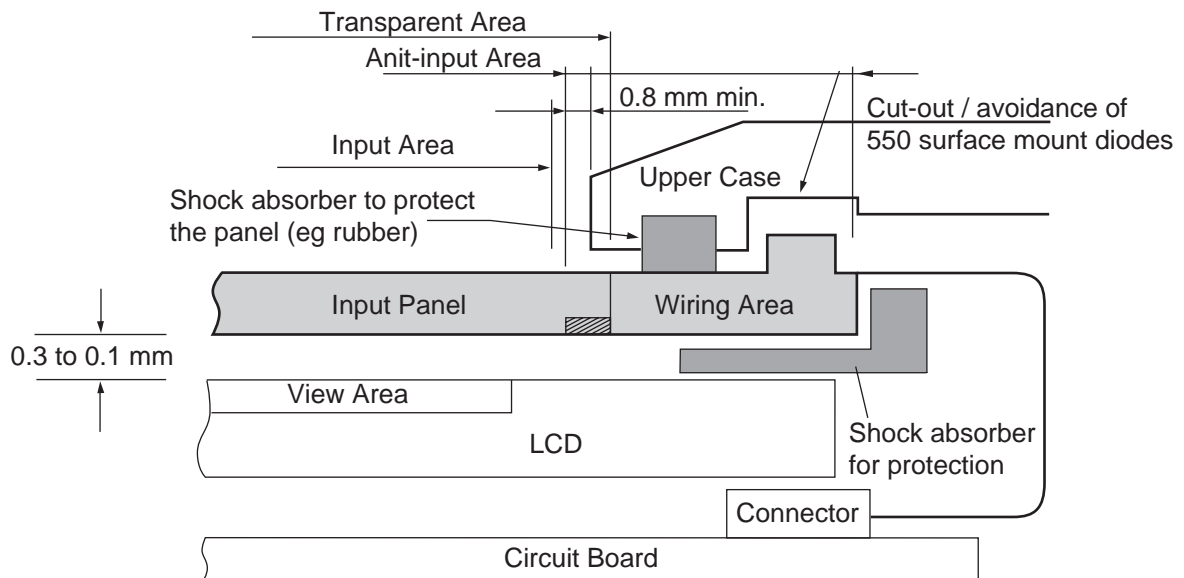

## ■ 10.0 PANEL THICKNESS

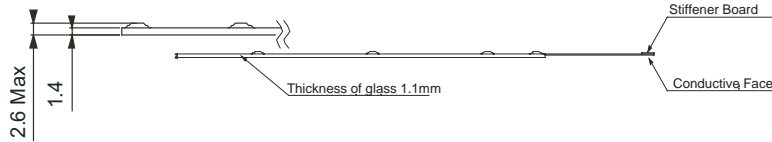

### **Fujitsu Components International Headquarter Offices**

#### **Japan**

Fujitsu Component Limited  
Gotanda-Chuo Building  
3-5, Higashigotanda 2-chome, Shinagawa-ku  
Tokyo 141, Japan  
Tel: (81-3) 5449-7010  
Fax: (81-3) 5449-2626  
Email: [promothq@ft.ed.fujitsu.com](mailto:promothq@ft.ed.fujitsu.com)  
Web: [www.fcl.fujitsu.com](http://www.fcl.fujitsu.com)

#### **North and South America**

Fujitsu Components America, Inc.  
250 E. Caribbean Drive  
Sunnyvale, CA 94089 U.S.A.  
Tel: (1-408) 745-4900  
Fax: (1-408) 745-4970  
Email: [marcom@fcai.fujitsu.com](mailto:marcom@fcai.fujitsu.com)  
Web: [www.fcai.fujitsu.com](http://www.fcai.fujitsu.com)

#### **Europe**

Fujitsu Components Europe B.V.  
Diamantlaan 25  
2132 WV Hoofddorp  
Netherlands  
Tel: (31-23) 5560910  
Fax: (31-23) 5560950  
Email: [info@fceu.fujitsu.com](mailto:info@fceu.fujitsu.com)  
Web: [www.fceu.fujitsu.com](http://www.fceu.fujitsu.com)

#### **Asia Pacific**

Fujitsu Components Asia Ltd.  
102E Pasir Panjang Road  
#04-01 Citilink Warehouse Complex  
Singapore 118529  
Tel: (65) 375-8560  
Fax: (65) 273-3021  
Email: [fcal@fcal.fujitsu.com](mailto:fcal@fcal.fujitsu.com)  
[www.fcal.fujitsu.com](http://www.fcal.fujitsu.com)

© 2004 Fujitsu Components America, Inc. All company and product names are trademarks or registered trademarks of their respective owners. Rev. 11/02/2004.