

**PLEASE CHECK WWW.MOLEX.COM FOR LATEST PART INFORMATION**

**Part Number:** [0459704117](#)  
**Status:** **Active**  
**Overview:** [searay](#)  
**Description:** 1.27mm (.050") x 1.27mm (.050") Pitch SEARAY\* Plug, 400 Circuits, 2.00mm (.078") Unmated Height, 10 Rows

**Documents:**

<a href="#">3D Model</a>	<a href="#">Product Specification PS-45970-002 (PDF)</a>
<a href="#">Drawing (PDF)</a>	<a href="#">RoHS Certificate of Compliance (PDF)</a>
<a href="#">Product Specification PS-45970-001 (PDF)</a>	

**Agency Certification**

CSA	LR19980
UL	E29179

**General**

Product Family	PCB Headers
Series	<a href="#">45970</a>
Application	Board-to-Board
Overview	<a href="#">searay</a>
Product Name	SEARAY*

**Physical**

Breakaway	No
Circuits (Loaded)	400
Circuits (maximum)	400
Circuits Detail	400
Color - Resin	Black
Durability (mating cycles max)	100
First Mate / Last Break	No
Flammability	94V-0
Glow-Wire Compliant	No
Guide to Mating Part	Yes
Keying to Mating Part	None
Lock to Mating Part	Yes
Material - Metal	Copper Alloy
Material - Plating Mating	Gold
Material - Plating Termination	Tin-Lead
Material - Resin	High Temperature Thermoplastic
Number of Rows	10
Orientation	Vertical
PCB Locator	Yes
PCB Retention	Yes
PCB Thickness Recommended (in)	0.062 In
PCB Thickness Recommended (mm)	1.60 mm
Packaging Type	Embossed Tape on Reel
Pitch - Mating Interface (in)	0.050 In
Pitch - Mating Interface (mm)	1.27 mm
Pitch - Term. Interface (in)	0.050 In
Pitch - Term. Interface (mm)	1.27 mm
Plating min: Mating (µin)	30
Plating min: Mating (µm)	0.75
Plating min: Termination (µin)	100
Plating min: Termination (µm)	2.5
Polarized to Mating Part	Yes
Polarized to PCB	Yes



**EU RoHS** **China RoHS**

**Not RoHS Compliant**  
**REACH SVHC**  
 Not Reviewed  
**Halogen-Free**  
**Status**  
**Not Reviewed**



**Need more information on product environmental compliance?**

Email [productcompliance@molex.com](mailto:productcompliance@molex.com)  
 For a multiple part number RoHS Certificate of Compliance, [click here](#)

Please visit the [Contact Us](#) section for any non-product compliance questions.

**Search Parts in this Series**

[45970Series](#)

**Mates With**

[45971 SEARAY\\* Receptacle](#)

Robotic Placement	Pick and Place Cap
Shrouded	No
Stackable	No
Surface Mount Compatible (SMC)	Yes
Temperature Range - Operating	-55°C to +125°C
Termination Interface: Style	Surface Mount

### Electrical

Current - Maximum per Contact	2.7A
Voltage - Maximum	240V AC

### Solder Process Data

Duration at Max. Process Temperature (seconds)	3
Lead-free Process Capability	Reflow Capable (SMT only)
Max. Cycles at Max. Process Temperature	1
Process Temperature max. C	230
Replacement RoHS Compliant Part Number	0459704115

### Material Info

#### Reference - Drawing Numbers

Application Specification	AS-45970-002, AS-45970-990
Packaging Specification	PK-45970-001, PK-45970-002
Product Specification	PS-45970-001, PS-45970-002
Sales Drawing	SD-45970-001
Test Summary	TS-45970-001

\*SEARAY is a trademark of Samtec, Inc.

This document was generated on 05/25/2010

**PLEASE CHECK [WWW.MOLEX.COM](http://WWW.MOLEX.COM) FOR LATEST PART INFORMATION**



NOTES:

- MATERIAL: HOUSING: LCP, UL94V-0, BLACK  
CONTACTS: COPPER ALLOY  
SOLDER CHARGE: SEE CHARTS
- FINISH: ALL OPTIONS - SELECT GOLD IN CONTACT AREA: 30 MI MIN  
OPTIONS 2.0 & 2.5: SELECT GOLD FLASH IN TAIL, 7 MI MIN  
OPTIONS 3.0 THRU 7.0: SELECT TIN IN TAIL, 100 MI MIN  
ALL OPTIONS - OVER NICKEL
- PRODUCT SPECIFICATION: PS-45970-001
- PACKAGING SPECIFICATION: SEE CHART
- MATES WITH SEARAY RECEPTACLE ASSY 45971
- APPLICATION SPECIFICATION; AS-45970-001
- COSMETIC SPECIFICATION: PS-45499-002 CLASS B
- PART STATUS: CONTACT MOLEX

POSITION	
19	.006
10	.006
20	.006
30	.006
40	.006
50	.006
15	.006
25	.006
35	.009
45	.009

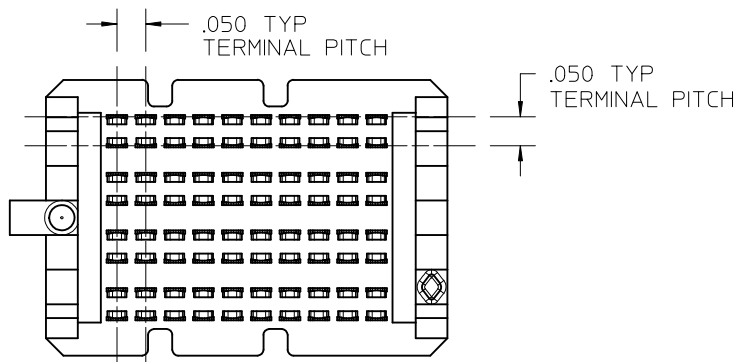
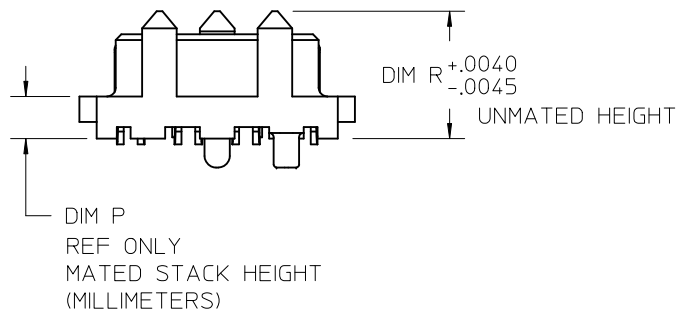

HOUSING OPTIONS  
SEE CHARTS

UPDATED NOTE 2 EC NO: UCP2010-2270 DRWN: TGREGORI 2010/03/05 CH'KD: JCOMERCI 2010/03/05 APPR: JCOMERCI 2010/03/05	DESCRIPTION
	REV
	M

GENERAL TOLERANCES  
(UNLESS SPECIFIED)

	mm	INCH
4 PLACES	± ---	± ---
3 PLACES	± ---	± .010
2 PLACES	± ---	± .015
1 PLACE	± ---	± ---
ANGULAR ± ---°		

DRAFT WHERE APPLICABLE  
MUST REMAIN  
WITHIN DIMENSIONS

DIMENSION STYLE  
INCH ONLY

DRAWN BY	DATE
TGREGORI	2005/01/27
CHECKED BY	DATE
JCOMERCI	
APPROVED BY	DATE
JCOMERCI	2010/03/05
MATERIAL NO.	
SEE CHART	

SCALE  
3:1

DESIGN UNITS  
INCH

THIRD ANGLE  
PROJECTION

TITLE		SEARAY PLUG ASSEMBLY .050 CENTERS
MOLEX INCORPORATED		
DOCUMENT NO.	SD-45970-001	SHEET NO. 1 OF 10

THIS DRAWING CONTAINS INFORMATION THAT IS PROPRIETARY TO MOLEX  
INCORPORATED AND SHOULD NOT BE USED WITHOUT WRITTEN PERMISSION



NO OF ROWS	DIM C	DIM E
6	.378	.125
8	.478	.175
10	.578	.225
12	.678	.275

		DIM R RECEPTACLE STACK HEIGHT				
		5.0	6.0	6.5	7.5	8.0
DIM P PLUG STACK HEIGHT	2.0	7.0	8.0	8.5	9.5	10.0
	3.0	8.0	9.0	9.5	10.5	11.0
	3.5	8.5	9.5	10.0	11.0	11.5
	2.5	7.5	8.5	9.0	10.0	10.5
	4.5	9.5	10.5	11.0	12.0	12.5
	5.0	10.0	11.0	11.5	12.5	13.0
	7.0	12.0	13.0	13.5	14.5	15.0

MATED STACK HEIGHTS (MILLIMETERS) REF

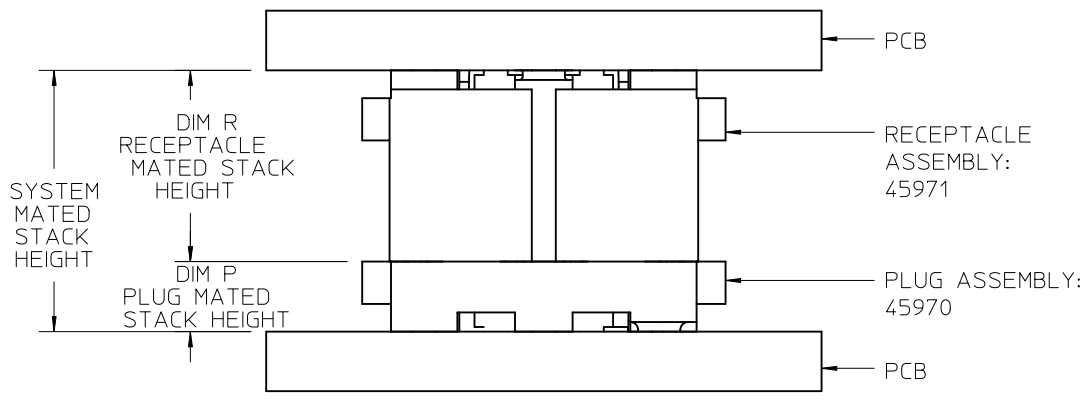

STACK HEIGHTS GIVEN IN METRIC FOR REF ONLY

SEE SHEET 1 EC NO: UCP2010-2270 DRWN: TGREGORI 2010/03/05 CH'KD: JCOMERCI 2010/03/05 APPR: JCOMERCI 2010/03/05	DESCRIPTION REV	GENERAL TOLERANCES (UNLESS SPECIFIED)		DIMENSION STYLE <b>INCH ONLY</b>		SCALE <b>4:1</b>	DESIGN UNITS <b>INCH</b>	THIRD ANGLE PROJECTION	
		4 PLACES ± --- ± ---	mm INCH	DRAWN BY TGREGORI	DATE 2005/01/27	TITLE <b>SEARAY          PLUG ASSEMBLY          .050 CENTERS</b>			
		3 PLACES ± --- ± .010		CHECKED BY JCOMERCI	DATE				
		2 PLACES ± --- ± .015		APPROVED BY JCOMERCI	DATE 2010/03/05	DOCUMENT NO. <b>SD-45970-001</b>	SHEET NO. <b>2 OF 10</b>		
DRAFT WHERE APPLICABLE MUST REMAIN WITHIN DIMENSIONS		SIZE <b>A</b>	THIS DRAWING CONTAINS INFORMATION THAT IS PROPRIETARY TO MOLEX INCORPORATED AND SHOULD NOT BE USED WITHOUT WRITTEN PERMISSION						

6		5		4		3		2		1					
DIM P:		2.0 MM		3.0 MM		3.5 MM		2.5 MM		4.5 MM		5.0 MM		7.0 MM	
DIM R:		.221		.260		.280		.241		.319		.339		.418	
D TRAY PACK PK-45971-001	POSITION	DIM G	MATERIAL NO	MATERIAL NO	MATERIAL NO	MATERIAL NO	MATERIAL NO	MATERIAL NO	MATERIAL NO	MATERIAL NO	MATERIAL NO	MATERIAL NO	MATERIAL NO	MATERIAL NO	MATERIAL NO
	19	1.146	45970-0161	45970-0261	45970-0361	45970-0461	45970-0561	45970-0661	45970-0761	45970-0861	45970-0961	45970-1061	45970-1161	45970-1261	45970-1361
	10	0.696	45970-1161	45970-1261	45970-1361	45970-1461	45970-1561	45970-1661	45970-1761	45970-1861	45970-1961	45970-2061	45970-2161	45970-2261	45970-2361
	20	1.196	45970-2161	45970-2261	45970-2361	45970-2461	45970-2561	45970-2661	45970-2761	45970-2861	45970-2961	45970-3061	45970-3161	45970-3261	45970-3361
	30	1.696	45970-3161	45970-3261	45970-3361	45970-3461	45970-3561	45970-3661	45970-3761	45970-3861	45970-3961	45970-4061	45970-4161	45970-4261	45970-4361
	40	2.196	45970-4161	45970-4261	45970-4361	45970-4461	45970-4561	45970-4661	45970-4761	45970-4861	45970-4961	45970-5061	45970-5161	45970-5261	45970-5361
	50	2.696	45970-5161	45970-5261	45970-5361	45970-5461	45970-5561	45970-5661	45970-5761	45970-5861	45970-5961	45970-6061	45970-6161	45970-6261	45970-6361
	15	0.946	45970-6161	45970-6261	45970-6361	45970-6461	45970-6561	45970-6661	45970-6761	45970-6861	45970-6961	45970-7061	45970-7161	45970-7261	45970-7361
	25	1.446	45970-7161	45970-7261	45970-7361	45970-7461	45970-7561	45970-7661	45970-7761	45970-7861	45970-7961	45970-8061	45970-8161	45970-8261	45970-8361
	35	1.946	45970-8161	45970-8261	45970-8361	45970-8461	45970-8561	45970-8661	45970-8761	45970-8861	45970-8961	45970-9061	45970-9161	45970-9261	45970-9361
	45	2.446	45970-9161	45970-9261	45970-9361	45970-9461	45970-9561	45970-9661	45970-9761	45970-9861	45970-9961	45970-0061	45970-0161	45970-0261	45970-0361

6		5		4		3		2		1					
DIM P:		2.0 MM		3.0 MM		3.5 MM		2.5 MM		4.5 MM		5.0 MM		7.0 MM	
DIM R:		.221		.260		.280		.241		.319		.339		.418	
C TAPE AND REEL PACK PK-45971-002	POSITION	DIM G	MATERIAL NO	MATERIAL NO	MATERIAL NO	MATERIAL NO	MATERIAL NO	MATERIAL NO	MATERIAL NO	MATERIAL NO	MATERIAL NO	MATERIAL NO	MATERIAL NO	MATERIAL NO	MATERIAL NO
	19	1.146	45970-0165	45970-0265	45970-0365	45970-0465	45970-0565	45970-0665	45970-0765	45970-0865	45970-0965	45970-1065	45970-1165	45970-1265	45970-1365
	10	0.696	45970-1165	45970-1265	45970-1365	45970-1465	45970-1565	45970-1665	45970-1765	45970-1865	45970-1965	45970-2065	45970-2165	45970-2265	45970-2365
	20	1.196	45970-2165	45970-2265	45970-2365	45970-2465	45970-2565	45970-2665	45970-2765	45970-2865	45970-2965	45970-3065	45970-3165	45970-3265	45970-3365
	30	1.696	45970-3165	45970-3265	45970-3365	45970-3465	45970-3565	45970-3665	45970-3765	45970-3865	45970-3965	45970-4065	45970-4165	45970-4265	45970-4365
	40	2.196	45970-4165	45970-4265	45970-4365	45970-4465	45970-4565	45970-4665	45970-4765	45970-4865	45970-4965	45970-5065	45970-5165	45970-5265	45970-5365
	50	2.696	45970-5165	45970-5265	45970-5365	45970-5465	45970-5565	45970-5665	45970-5765	45970-5865	45970-5965	45970-6065	45970-6165	45970-6265	45970-6365
	15	0.946	45970-6165	45970-6265	45970-6365	45970-6465	45970-6565	45970-6665	45970-6765	45970-6865	45970-6965	45970-7065	45970-7165	45970-7265	45970-7365
	25	1.446	45970-7165	45970-7265	45970-7365	45970-7465	45970-7565	45970-7665	45970-7765	45970-7865	45970-7965	45970-8065	45970-8165	45970-8265	45970-8365
	35	1.946	45970-8165	45970-8265	45970-8365	45970-8465	45970-8565	45970-8665	45970-8765	45970-8865	45970-8965	45970-9065	45970-9165	45970-9265	45970-9365
	45	2.446	45970-9165	45970-9265	45970-9365	45970-9465	45970-9565	45970-9665	45970-9765	45970-9865	45970-9965	45970-0065	45970-0165	45970-0265	45970-0365

NOTES:  
 1. THIS SHEET CONTAINS THE FOLLOWING OPTIONS:  
 NO OF ROWS: 6  
 SOLDER CHARGE: TIN  
 PACKAGING: TRAYS AND TAPE AND REEL

SEE SHEET 1 EC NO: UCP2010-2270 DRWN: TGREGORI 2010/03/05 CHKD: JCOMERCI 2010/03/05 APPR: JCOMERCI 2010/03/05	DESCRIPTION REV	GENERAL TOLERANCES (UNLESS SPECIFIED)		DIMENSION STYLE <b>INCH ONLY</b>		SCALE <b>4:1</b>	DESIGN UNITS <b>INCH</b>	THIRD ANGLE PROJECTION		
			mm	INCH	DRAWN BY TGREGORI	DATE 2005/01/27	TITLE <b>SEARAY          PLUG ASSEMBLY          .050 CENTERS</b>			
		4 PLACES	± ---	± ---	CHECKED BY JCOMERCI	DATE				
		3 PLACES	± ---	± .010	APPROVED BY JCOMERCI	DATE 2010/03/05				
		2 PLACES	± ---	± .015	ANGULAR ± ---°		<b>MOLEX INCORPORATED</b>		DOCUMENT NO. <b>SD-45970-001</b>	SHEET NO. <b>3 OF 10</b>
1 PLACE	± ---	± ---	DRAFT WHERE APPLICABLE MUST REMAIN WITHIN DIMENSIONS		SIZE <b>A</b>	THIS DRAWING CONTAINS INFORMATION THAT IS PROPRIETARY TO MOLEX INCORPORATED AND SHOULD NOT BE USED WITHOUT WRITTEN PERMISSION				

D	TRAY PACK PK-45971-001	6		5		4		3		2		1		
		DIM P:		2.0 MM	3.0 MM	3.5 MM	2.5 MM	4.5 MM	5.0 MM	7.0 MM				
		DIM R:		.221	.260	.280	.241	3.19	.339	.418				
		POSITION	DIM G	MATERIAL NO	MATERIAL NO	MATERIAL NO	MATERIAL NO	MATERIAL NO	MATERIAL NO	MATERIAL NO				
		19	1.146	45970-0163	45970-0263	45970-0363	45970-0463	45970-0563	45970-0663	45970-0763				
		10	0.696	45970-1163	45970-1263	45970-1363	45970-1463	45970-1563	45970-1663	45970-1763				
		20	1.196	45970-2163	45970-2263	45970-2363	45970-2463	45970-2563	45970-2663	45970-2763				
		30	1.696	45970-3163	45970-3263	45970-3363	45970-3463	45970-3563	45970-3663	45970-3763				
		40	2.196	45970-4163	45970-4263	45970-4363	45970-4463	45970-4563	45970-4663	45970-4763				
		50	2.696	45970-5163	45970-5263	45970-5363	45970-5463	45970-5563	45970-5663	45970-5763				
		15	0.946	45970-6163	45970-6263	45970-6363	45970-6463	45970-6563	45970-6663	45970-6763				
		25	1.446	45970-7163	45970-7263	45970-7363	45970-7463	45970-7563	45970-7663	45970-7763				
		35	1.946	45970-8163	45970-8263	45970-8363	45970-8463	45970-8563	45970-8663	45970-8763				
45	2.446	45970-9163	45970-9263	45970-9363	45970-9463	45970-9563	45970-9663	45970-9763						

C	TAPE AND REEL PACK PK-45971-002	6		5		4		3		2		1		
		DIM P:		2.0 MM	3.0 MM	3.5 MM	2.5 MM	4.5 MM	5.0 MM	7.0 MM				
		DIM R:		.221	.260	.280	.241	.319	.339	.418				
		POSITION	DIM G	MATERIAL NO	MATERIAL NO	MATERIAL NO	MATERIAL NO	MATERIAL NO	MATERIAL NO	MATERIAL NO				
		19	1.146	45970-0167	45970-0267	45970-0367	45970-0467	45970-0567	45970-0667	45970-0767				
		10	0.696	45970-1167	45970-1267	45970-1367	45970-1467	45970-1567	45970-1667	45970-1767				
		20	1.196	45970-2167	45970-2267	45970-2367	45970-2467	45970-2567	45970-2667	45970-2767				
		30	1.696	45970-3167	45970-3267	45970-3367	45970-3467	45970-3567	45970-3667	45970-3767				
		40	2.196	45970-4167	45970-4267	45970-4367	45970-4467	45970-4567	45970-4667	45970-4767				
		50	2.696	45970-5167	45970-5267	45970-5367	45970-5467	45970-5567	45970-5667	45970-5767				
		15	0.946	45970-6167	45970-6267	45970-6367	45970-6467	45970-6567	45970-6667	45970-6767				
		25	1.446	45970-7167	45970-7267	45970-7367	45970-7467	45970-7567	45970-7667	45970-7767				
		35	1.946	45970-8167	45970-8267	45970-8367	45970-8467	45970-8567	45970-8667	45970-8767				
45	2.446	45970-9167	45970-9267	45970-9367	45970-9467	45970-9567	45970-9667	45970-9767						

NOTES:  
 1. THIS SHEET CONTAINS THE FOLLOWING OPTIONS  
 ROWS: 6  
 SOLDER CHARGE: TIN / LEAD  
 PACKAGING: TRAYS AND TAPE AND REEL

A	SEE SHEET 1 EC NO: UCP2010-2270 DRWN: TGREGORI 2010/03/05 CHKD: JCOMERCI 2010/03/05 APPR: JCOMERCI 2010/03/05	DESCRIPTION	GENERAL TOLERANCES (UNLESS SPECIFIED)		DIMENSION STYLE <b>INCH ONLY</b>		SCALE <b>4:1</b>	DESIGN UNITS <b>INCH</b>	THIRD ANGLE PROJECTION		
				mm	INCH	DRAWN BY	DATE	TITLE <b>SEARAY PLUG ASSEMBLY .050 CENTERS</b>			
			4 PLACES	± ---	± ---	TGREGORI	2005/01/27				
			3 PLACES	± ---	± .010	CHECKED BY	DATE				
			2 PLACES	± ---	± .015	JCOMERCI		MOLEX INCORPORATED			
1 PLACE	± ---	± ---	APPROVED BY	DATE							
ANGULAR ± ---°			JCOMERCI	2010/03/05	DOCUMENT NO.	<b>SD-45970-001</b>		SHEET NO. 4 OF 10			
DRAFT WHERE APPLICABLE MUST REMAIN WITHIN DIMENSIONS			SIZE <b>A</b>	THIS DRAWING CONTAINS INFORMATION THAT IS PROPRIETARY TO MOLEX INCORPORATED AND SHOULD NOT BE USED WITHOUT WRITTEN PERMISSION							

6		5		4		3		2		1					
DIM P:		2.0 MM		3.0 MM		2.5 MM		4.5 MM		5.0 MM		7.0 MM			
DIM R:		.221		.260		.280		.241		.319		.339		.418	
POSITION	DIM G	MATERIAL NO	MATERIAL NO	MATERIAL NO	MATERIAL NO	MATERIAL NO	MATERIAL NO	MATERIAL NO	MATERIAL NO	MATERIAL NO	MATERIAL NO	MATERIAL NO	MATERIAL NO		
19	1.146	45970-0181	45970-0281	45970-0381	45970-0481	45970-0581	45970-0681	45970-0781	45970-0881	45970-0981	45970-1081	45970-1181	45970-1281		
10	0.696	45970-1181	45970-1281	45970-1381	45970-1481	45970-1581	45970-1681	45970-1781	45970-1881	45970-1981	45970-2081	45970-2181	45970-2281		
20	1.196	45970-2181	45970-2281	45970-2381	45970-2481	45970-2581	45970-2681	45970-2781	45970-2881	45970-2981	45970-3081	45970-3181	45970-3281		
30	1.696	45970-3181	45970-3281	45970-3381	45970-3481	45970-3581	45970-3681	45970-3781	45970-3881	45970-3981	45970-4081	45970-4181	45970-4281		
40	2.196	45970-4181	45970-4281	45970-4381	45970-4481	45970-4581	45970-4681	45970-4781	45970-4881	45970-4981	45970-5081	45970-5181	45970-5281		
50	2.696	45970-5181	45970-5281	45970-5381	45970-5481	45970-5581	45970-5681	45970-5781	45970-5881	45970-5981	45970-6081	45970-6181	45970-6281		
15	0.946	45970-6181	45970-6281	45970-6381	45970-6481	45970-6581	45970-6681	45970-6781	45970-6881	45970-6981	45970-7081	45970-7181	45970-7281		
25	1.446	45970-7181	45970-7281	45970-7381	45970-7481	45970-7581	45970-7681	45970-7781	45970-7881	45970-7981	45970-8081	45970-8181	45970-8281		
35	1.946	45970-8181	45970-8281	45970-8381	45970-8481	45970-8581	45970-8681	45970-8781	45970-8881	45970-8981	45970-9081	45970-9181	45970-9281		
45	2.446	45970-9181	45970-9281	45970-9381	45970-9481	45970-9581	45970-9681	45970-9781	45970-9881	45970-9981	45970-10081	45970-10181	45970-10281		

6		5		4		3		2		1					
DIM P:		2.0 MM		3.0 MM		2.5 MM		4.5 MM		5.0 MM		7.0 MM			
DIM R:		.221		.260		.280		.241		.319		.339		.418	
POSITION	DIM G	MATERIAL NO	MATERIAL NO	MATERIAL NO	MATERIAL NO	MATERIAL NO	MATERIAL NO	MATERIAL NO	MATERIAL NO	MATERIAL NO	MATERIAL NO	MATERIAL NO	MATERIAL NO		
19	1.146	45970-0185	45970-0285	45970-0385	45970-0485	45970-0585	45970-0685	45970-0785	45970-0885	45970-0985	45970-1085	45970-1185	45970-1285		
10	0.696	45970-1185	45970-1285	45970-1385	45970-1485	45970-1585	45970-1685	45970-1785	45970-1885	45970-1985	45970-2085	45970-2185	45970-2285		
20	1.196	45970-2185	45970-2285	45970-2385	45970-2485	45970-2585	45970-2685	45970-2785	45970-2885	45970-2985	45970-3085	45970-3185	45970-3285		
30	1.696	45970-3185	45970-3285	45970-3385	45970-3485	45970-3585	45970-3685	45970-3785	45970-3885	45970-3985	45970-4085	45970-4185	45970-4285		
40	2.196	45970-4185	45970-4285	45970-4385	45970-4485	45970-4585	45970-4685	45970-4785	45970-4885	45970-4985	45970-5085	45970-5185	45970-5285		
50	2.696	45970-5185	45970-5285	45970-5385	45970-5485	45970-5585	45970-5685	45970-5785	45970-5885	45970-5985	45970-6085	45970-6185	45970-6285		
15	0.946	45970-6185	45970-6285	45970-6385	45970-6485	45970-6585	45970-6685	45970-6785	45970-6885	45970-6985	45970-7085	45970-7185	45970-7285		
25	1.446	45970-7185	45970-7285	45970-7385	45970-7485	45970-7585	45970-7685	45970-7785	45970-7885	45970-7985	45970-8085	45970-8185	45970-8285		
35	1.946	45970-8185	45970-8285	45970-8385	45970-8485	45970-8585	45970-8685	45970-8785	45970-8885	45970-8985	45970-9085	45970-9185	45970-9285		
45	2.446	45970-9185	45970-9285	45970-9385	45970-9485	45970-9585	45970-9685	45970-9785	45970-9885	45970-9985	45970-10085	45970-10185	45970-10285		

NOTES:  
 1. THIS SHEET CONTAINS THE FOLLOWING OPTIONS  
 ROWS: 8  
 SOLDER CHARGE: TIN  
 PACKAGING: TRAYS AND TAPE AND REEL

SEE SHEET 1 EC NO: UCP2010-2270 DRWN: TGREGORI 2010/03/05 CHKD: JCOMERCI 2010/03/05 APPR: JCOMERCI 2010/03/05	DESCRIPTION REV	GENERAL TOLERANCES (UNLESS SPECIFIED)		DIMENSION STYLE INCH ONLY		SCALE 4:1	DESIGN UNITS INCH	THIRD ANGLE PROJECTION		
			mm	INCH	DRAWN BY	DATE	TITLE SEARAY PLUG ASSEMBLY .050 CENTERS			
		4 PLACES	± ---	± ---	TGREGORI	2005/01/27				
		3 PLACES	± ---	± .010	CHECKED BY	DATE	MOLEX INCORPORATED			
		2 PLACES	± ---	± .015	JCOMERCI					
1 PLACE	± ---	± ---	APPROVED BY	DATE	DOCUMENT NO.	SHEET NO.				
		ANGULAR ± ---°	JCOMERCI	2010/03/05	SD-45970-001	5 OF 10				
DRAFT WHERE APPLICABLE MUST REMAIN WITHIN DIMENSIONS			SIZE A	THIS DRAWING CONTAINS INFORMATION THAT IS PROPRIETARY TO MOLEX INCORPORATED AND SHOULD NOT BE USED WITHOUT WRITTEN PERMISSION						

D	6		5		4		3		2		1	
	DIM P:		2.0 MM	3.0 MM	3.5 MM	2.5 MM	4.5 MM	5.0 MM	7.0 MM			
	DIM R:		.221	.260	.280	.241	.319	.339	.418			
	POSITION	DIM G	MATERIAL NO	MATERIAL NO	MATERIAL NO	MATERIAL NO	MATERIAL NO	MATERIAL NO	MATERIAL NO			
	19	1.146	45970-0183	45970-0283	45970-0383	45970-0483	45970-0583	45970-0683	45970-0783			
	10	0.696	45970-1183	45970-1283	45970-1383	45970-1483	45970-1583	45970-1683	45970-1783			
	20	1.196	45970-2183	45970-2283	45970-2383	45970-2483	45970-2583	45970-2683	45970-2783			
	30	1.696	45970-3183	45970-3283	45970-3383	45970-3483	45970-3583	45970-3683	45970-3783			
	40	2.196	45970-4183	45970-4283	45970-4383	45970-4483	45970-4583	45970-4683	45970-4783			
	50	2.696	45970-5183	45970-5283	45970-5383	45970-5483	45970-5583	45970-5683	45970-5783			
	15	0.446	45970-6183	45970-6283	45970-6383	45970-6483	45970-6583	45970-6683	45970-6783			
	25	0.946	45970-7183	45970-7283	45970-7383	45970-7483	45970-7583	45970-7683	45970-7783			
35	1.446	45970-8183	45970-8283	45970-8383	45970-8483	45970-8583	45970-8683	45970-8783				
45	1.946	45970-9183	45970-9283	45970-9383	45970-9483	45970-9583	45970-9683	45970-9783				

C	6		5		4		3		2		1	
	DIM P:		2.0 MM	3.0 MM	3.5 MM	2.5 MM	4.5 MM	5.0 MM	7.0 MM			
	DIM R:		.221	.260	.280	.241	.319	.339	.418			
	POSITION	DIM G	MATERIAL NO	MATERIAL NO	MATERIAL NO	MATERIAL NO	MATERIAL NO	MATERIAL NO	MATERIAL NO			
	19	1.146	45970-0187	45970-0287	45970-0387	45970-0487	45970-0587	45970-0687	45970-0787			
	10	0.696	45970-1187	45970-1287	45970-1387	45970-1487	45970-1587	45970-1687	45970-1787			
	20	1.196	45970-2187	45970-2287	45970-2387	45970-2487	45970-2587	45970-2687	45970-2787			
	30	1.696	45970-3187	45970-3287	45970-3387	45970-3487	45970-3587	45970-3687	45970-3787			
	40	2.196	45970-4187	45970-4287	45970-4387	45970-4487	45970-4587	45970-4687	45970-4787			
	50	2.696	45970-5187	45970-5287	45970-5387	45970-5487	45970-5587	45970-5687	45970-5787			
	15	0.946	45970-6187	45970-6287	45970-6387	45970-6487	45970-6587	45970-6687	45970-6787			
	25	1.446	45970-7187	45970-7287	45970-7387	45970-7487	45970-7587	45970-7687	45970-7787			
35	1.946	45970-8187	45970-8287	45970-8387	45970-8487	45970-8587	45970-8687	45970-8787				
45	2.446	45970-9187	45970-9287	45970-9387	45970-9487	45970-9587	45970-9687	45970-9787				

NOTES:  
1. THIS SHEET CONTAINS THE FOLLOWING OPTIONS  
ROWS: 8  
SOLDER CHARGE: TIN / LEAD  
PACKAGING: TRAYS AND TAPE AND REEL

A	SEE SHEET 1 EC NO: UCP2010-2270 DRWN: TGREGORI 2010/03/05 CHKD: JCOMERCI 2010/03/05 APPR: JCOMERCI 2010/03/05	DESCRIPTION	GENERAL TOLERANCES (UNLESS SPECIFIED)		DIMENSION STYLE INCH ONLY		SCALE 4:1	DESIGN UNITS INCH	THIRD ANGLE PROJECTION		
			4 PLACES	± ---	± ---	DRAWN BY TGREGORI	DATE 2005/01/27	TITLE SEARAY PLUG ASSEMBLY .050 CENTERS			
			3 PLACES	± ---	± .010	CHECKED BY JCOMERCI	DATE				
			2 PLACES	± ---	± .015	APPROVED BY JCOMERCI	DATE 2010/03/05	DOCUMENT NO. SD-45970-001			
1 PLACE	± ---	± ---	ANGULAR ± ---°		SHEET NO. 6 OF 10						
DRAFT WHERE APPLICABLE MUST REMAIN WITHIN DIMENSIONS			SIZE A	THIS DRAWING CONTAINS INFORMATION THAT IS PROPRIETARY TO MOLEX INCORPORATED AND SHOULD NOT BE USED WITHOUT WRITTEN PERMISSION							



6		5		4		3		2		1					
DIM P:		2.0 MM		3.0 MM		3.5 MM		2.5 MM		4.5 MM		5.0 MM		7.0 MM	
DIM R:		.221		.260		.280		.241		.319		.339		.418	
POSITION	DIM G	MATERIAL NO	MATERIAL NO	MATERIAL NO	MATERIAL NO	MATERIAL NO	MATERIAL NO	MATERIAL NO	MATERIAL NO	MATERIAL NO	MATERIAL NO	MATERIAL NO	MATERIAL NO	MATERIAL NO	MATERIAL NO
19	1.146	45970-0111	45970-0211	45970-0311	45970-0411	45970-0511	45970-0611	45970-0711	45970-0811	45970-0911	45970-1011	45970-1111	45970-1211	45970-1311	45970-1411
10	0.696	45970-1111	45970-1211	45970-1311	45970-1411	45970-1511	45970-1611	45970-1711	45970-1811	45970-1911	45970-2011	45970-2111	45970-2211	45970-2311	45970-2411
20	1.196	45970-2111	45970-2211	45970-2311	45970-2411	45970-2511	45970-2611	45970-2711	45970-2811	45970-2911	45970-3011	45970-3111	45970-3211	45970-3311	45970-3411
30	1.696	45970-3111	45970-3211	45970-3311	45970-3411	45970-3511	45970-3611	45970-3711	45970-3811	45970-3911	45970-4011	45970-4111	45970-4211	45970-4311	45970-4411
40	2.196	45970-4111	45970-4211	45970-4311	45970-4411	45970-4511	45970-4611	45970-4711	45970-4811	45970-4911	45970-5011	45970-5111	45970-5211	45970-5311	45970-5411
50	2.696	45970-5111	45970-5211	45970-5311	45970-5411	45970-5511	45970-5611	45970-5711	45970-5811	45970-5911	45970-6011	45970-6111	45970-6211	45970-6311	45970-6411
15	0.946	45970-6111	45970-6211	45970-6311	45970-6411	45970-6511	45970-6611	45970-6711	45970-6811	45970-6911	45970-7011	45970-7111	45970-7211	45970-7311	45970-7411
25	1.446	45970-7111	45970-7211	45970-7311	45970-7411	45970-7511	45970-7611	45970-7711	45970-7811	45970-7911	45970-8011	45970-8111	45970-8211	45970-8311	45970-8411
35	1.946	45970-8111	45970-8211	45970-8311	45970-8411	45970-8511	45970-8611	45970-8711	45970-8811	45970-8911	45970-9011	45970-9111	45970-9211	45970-9311	45970-9411
45	2.446	45970-9111	45970-9211	45970-9311	45970-9411	45970-9511	45970-9611	45970-9711	45970-9811	45970-9911	45970-10011	45970-10111	45970-10211	45970-10311	45970-10411

6		5		4		3		2		1					
DIM P:		2.0 MM		3.0 MM		3.5 MM		2.5 MM		4.5 MM		5.0 MM		7.0 MM	
DIM R:		.221		.260		.280		.241		.319		.339		.418	
POSITION	DIM G	MATERIAL NO	MATERIAL NO	MATERIAL NO	MATERIAL NO	MATERIAL NO	MATERIAL NO	MATERIAL NO	MATERIAL NO	MATERIAL NO	MATERIAL NO	MATERIAL NO	MATERIAL NO	MATERIAL NO	MATERIAL NO
19	1.146	45970-0115	45970-0215	45970-0315	45970-0415	45970-0515	45970-0615	45970-0715	45970-0815	45970-0915	45970-1015	45970-1115	45970-1215	45970-1315	45970-1415
10	0.696	45970-1115	45970-1215	45970-1315	45970-1415	45970-1515	45970-1615	45970-1715	45970-1815	45970-1915	45970-2015	45970-2115	45970-2215	45970-2315	45970-2415
20	1.196	45970-2115	45970-2215	45970-2315	45970-2415	45970-2515	45970-2615	45970-2715	45970-2815	45970-2915	45970-3015	45970-3115	45970-3215	45970-3315	45970-3415
30	1.696	45970-3115	45970-3215	45970-3315	45970-3415	45970-3515	45970-3615	45970-3715	45970-3815	45970-3915	45970-4015	45970-4115	45970-4215	45970-4315	45970-4415
40	2.196	45970-4115	45970-4215	45970-4315	45970-4415	45970-4515	45970-4615	45970-4715	45970-4815	45970-4915	45970-5015	45970-5115	45970-5215	45970-5315	45970-5415
50	2.696	45970-5115	45970-5215	45970-5315	45970-5415	45970-5515	45970-5615	45970-5715	45970-5815	45970-5915	45970-6015	45970-6115	45970-6215	45970-6315	45970-6415
15	0.946	45970-6115	45970-6215	45970-6315	45970-6415	45970-6515	45970-6615	45970-6715	45970-6815	45970-6915	45970-7015	45970-7115	45970-7215	45970-7315	45970-7415
25	1.446	45970-7115	45970-7215	45970-7315	45970-7415	45970-7515	45970-7615	45970-7715	45970-7815	45970-7915	45970-8015	45970-8115	45970-8215	45970-8315	45970-8415
35	1.946	45970-8115	45970-8215	45970-8315	45970-8415	45970-8515	45970-8615	45970-8715	45970-8815	45970-8915	45970-9015	45970-9115	45970-9215	45970-9315	45970-9415
45	2.446	45970-9115	45970-9215	45970-9315	45970-9415	45970-9515	45970-9615	45970-9715	45970-9815	45970-9915	45970-10015	45970-10115	45970-10215	45970-10315	45970-10415



NOTES:  
 1. THIS SHEET CONTAINS THE FOLLOWING OPTIONS  
 ROWS: 10  
 SOLDER CHARGE: TIN  
 PACKAGING: TRAYS AND TAPE AND REEL

SEE SHEET 1 EC NO: UCP2010-2270 DRWN: TGREGOR I 2010/03/05 CHKD: JCOMERC I 2010/03/05 APPR: JCOMERC I 2010/03/05	DESCRIPTION REV	GENERAL TOLERANCES (UNLESS SPECIFIED)		DIMENSION STYLE INCH ONLY		SCALE 4:1	DESIGN UNITS INCH	THIRD ANGLE PROJECTION		
			mm	INCH	DRAWN BY TGREGOR I	DATE 2005/01/27	TITLE <b>SEARAY          PLUG ASSEMBLY          .050 CENTERS</b>			
		4 PLACES	± ---	± ---	CHECKED BY JCOMERC I	DATE				
		3 PLACES	± ---	± .010	APPROVED BY JCOMERC I	DATE 2010/03/05				
		2 PLACES	± ---	± .015	ANGULAR ± ---°		 <b>MOLEX INCORPORATED</b>		DOCUMENT NO. SD-45970-001	SHEET NO. 7 OF 10
1 PLACE	± ---	± ---	DRAFT WHERE APPLICABLE MUST REMAIN WITHIN DIMENSIONS		THIS DRAWING CONTAINS INFORMATION THAT IS PROPRIETARY TO MOLEX INCORPORATED AND SHOULD NOT BE USED WITHOUT WRITTEN PERMISSION					

D	TRAY PACK PK-45971-001	DIM P:		2.0 MM	3.0 MM	3.5 MM	2.5 MM	4.5 MM	5.0 MM	7.0 MM
		DIM R:		.221	.260	.280	.241	.319	.339	.418
		POSITION	DIM G	MATERIAL NO	MATERIAL NO	MATERIAL NO	MATERIAL NO	MATERIAL NO	MATERIAL NO	MATERIAL NO
		19	1.146	45970-0113	45970-0213	45970-0313	45970-0413	45970-0513	45970-0613	45970-0713
		10	0.696	45970-1113	45970-1213	45970-1313	45970-1413	45970-1513	45970-1613	45970-1713
		20	1.196	45970-2113	45970-2213	45970-2313	45970-2413	45970-2513	45970-2613	45970-2713
		30	1.696	45970-3113	45970-3213	45970-3313	45970-3413	45970-3513	45970-3613	45970-3713
		40	2.196	45970-4113	45970-4213	45970-4313	45970-4413	45970-4513	45970-4613	45970-4713
		50	2.696	45970-5113	45970-5213	45970-5313	45970-5413	45970-5513	45970-5613	45970-5713
		15	0.946	45970-6113	45970-6213	45970-6313	45970-6413	45970-6513	45970-6613	45970-6713
		25	1.446	45970-7113	45970-7213	45970-7313	45970-7413	45970-7513	45970-7613	45970-7713
		35	1.946	45970-8113	45970-8213	45970-8313	45970-8413	45970-8513	45970-8613	45970-8713
45	2.446	45970-9113	45970-9213	45970-9313	45970-9413	45970-9513	45970-9613	45970-9713		

C	TAPE AND REEL PACK PK-45971-002	DIM P:		2.0 MM	3.0 MM	3.5 MM	2.5 MM	4.5 MM	5.0 MM	7.0 MM
		DIM R:		.221	.260	.280	.241	.319	.339	.418
		POSITION	DIM G	MATERIAL NO	MATERIAL NO	MATERIAL NO	MATERIAL NO	MATERIAL NO	MATERIAL NO	MATERIAL NO
		19	1.146	45970-0117	45970-0217	45970-0317	45970-0417	45970-0517	45970-0617	45970-0717
		10	0.696	45970-1117	45970-1217	45970-1317	45970-1417	45970-1517	45970-1617	45970-1717
		20	1.196	45970-2117	45970-2217	45970-2317	45970-2417	45970-2517	45970-2617	45970-2717
		30	1.696	45970-3117	45970-3217	45970-3317	45970-3417	45970-3517	45970-3617	45970-3717
		40	2.196	45970-4117	45970-4217	45970-4317	45970-4417	45970-4517	45970-4617	45970-4717
		50	2.696	45970-5117	45970-5217	45970-5317	45970-5417	45970-5517	45970-5617	45970-5717
		15	0.946	45970-6117	45970-6217	45970-6317	45970-6417	45970-6517	45970-6617	45970-6717
		25	1.446	45970-7117	45970-7217	45970-7317	45970-7417	45970-7517	45970-7617	45970-7717
		35	1.946	45970-8117	45970-8217	45970-8317	45970-8417	45970-8517	45970-8617	45970-8717
45	2.446	45970-9117	45970-9217	45970-9317	45970-9417	45970-9517	45970-9617	45970-9717		

NOTES:  
 1. THIS SHEET CONTAINS THE FOLLOWING OPTIONS  
 ROWS: 10  
 SOLDER CHARGE: TIN / LEAD  
 PACKAGING: TRAYS AND TAPE AND REEL

SEE SHEET 1 EC NO: UCP2010-2270 DRWN: TGREGOR I 2010/03/05 CHKD: JCOMERC I 2010/03/05 APPR: JCOMERC I 2010/03/05	DESCRIPTION REV	GENERAL TOLERANCES (UNLESS SPECIFIED)		DIMENSION STYLE <b>INCH ONLY</b>		SCALE <b>4:1</b>	DESIGN UNITS <b>INCH</b>	THIRD ANGLE PROJECTION		
			mm	INCH	DRAWN BY TGREGOR I	DATE 2005/01/27	TITLE <b>SEARAY          PLUG ASSEMBLY          .050 CENTERS</b>			
		4 PLACES	± ---	± ---	CHECKED BY JCOMERC I	DATE				
		3 PLACES	± ---	± .010	APPROVED BY JCOMERC I	DATE 2010/03/05				
		2 PLACES	± ---	± .015	ANGULAR ± ---°		 <b>MOLEX INCORPORATED</b>		DOCUMENT NO. <b>SD-45970-001</b>	SHEET NO. <b>8 OF 10</b>
1 PLACE	± ---	± ---	DRAFT WHERE APPLICABLE MUST REMAIN WITHIN DIMENSIONS		SIZE 	THIS DRAWING CONTAINS INFORMATION THAT IS PROPRIETARY TO MOLEX INCORPORATED AND SHOULD NOT BE USED WITHOUT WRITTEN PERMISSION				

6		5		4		3		2		1					
DIM P:		2.0 MM		3.0 MM		2.5 MM		4.5 MM		5.0 MM		7.0 MM			
DIM R:		.221		.260		.280		.241		.319		.339		.418	
POSITION	DIM G	MATERIAL NO		MATERIAL NO		MATERIAL NO		MATERIAL NO		MATERIAL NO		MATERIAL NO			
19	1.146	45970-0121		45970-0221		45970-0321		45970-0421		45970-0521		45970-0621		45970-0721	
10	0.696	45970-1121		45970-1221		45970-1321		45970-1421		45970-1521		45970-1621		45970-1721	
20	1.196	45970-2121		45970-2221		45970-2321		45970-2421		45970-2521		45970-2621		45970-2721	
30	1.696	45970-3121		45970-3221		45970-3321		45970-3421		45970-3521		45970-3621		45970-3721	
40	2.196	45970-4121		45970-4221		45970-4321		45970-4421		45970-4521		45970-4621		45970-4721	
50	2.696	45970-5121		45970-5221		45970-5321		45970-5421		45970-5521		45970-5621		45970-5721	
15	0.946	45970-6121		45970-6221		45970-6321		45970-6421		45970-6521		45970-6621		45970-6721	
25	1.446	45970-7121		45970-7221		45970-7321		45970-7421		45970-7521		45970-7621		45970-7721	
35	1.946	45970-8121		45970-8221		45970-8321		45970-8421		45970-8521		45970-8621		45970-8721	
45	2.446	45970-9121		45970-9221		45970-9321		45970-9421		45970-9521		45970-9621		45970-9721	

6		5		4		3		2		1					
DIM P:		2.0 MM		3.0 MM		2.5 MM		4.5 MM		5.0 MM		7.0 MM			
DIM R:		.221		.260		.280		.241		.319		.339		.418	
POSITION	DIM G	MATERIAL NO		MATERIAL NO		MATERIAL NO		MATERIAL NO		MATERIAL NO		MATERIAL NO			
19	1.146	45970-0125		45970-0225		45970-0325		45970-0425		45970-0525		45970-0625		45970-0725	
10	0.696	45970-1125		45970-1225		45970-1325		45970-1425		45970-1525		45970-1625		45970-1725	
20	1.196	45970-2125		45970-2225		45970-2325		45970-2425		45970-2525		45970-2625		45970-2725	
30	1.696	45970-3125		45970-3225		45970-3325		45970-3425		45970-3525		45970-3625		45970-3725	
40	2.196	45970-4125		45970-4225		45970-4325		45970-4425		45970-4525		45970-4625		45970-4725	
50	2.696	45970-5125		45970-5225		45970-5325		45970-5425		45970-5525		45970-5625		45970-5725	
15	0.946	45970-6125		45970-6225		45970-6325		45970-6425		45970-6525		45970-6625		45970-6725	
25	1.446	45970-7125		45970-7225		45970-7325		45970-7425		45970-7525		45970-7625		45970-7725	
35	1.946	45970-8125		45970-8225		45970-8325		45970-8425		45970-8525		45970-8625		45970-8725	
45	2.446	45970-9125		45970-9225		45970-9325		45970-9425		45970-9525		45970-9625		45970-9725	

NOTES:  
1. THIS SHEET CONTAINS THE FOLLOWING OPTIONS  
ROWS: 12  
SOLDER CHARGE: TIN  
PACKAGING: TRAYS AND TAPE AND REEL

<b>SEE SHEET 1</b> EC NO: UCP2010-2270 DRWN: T GREGORI 2010/03/05 CHKD: JCOMERCI 2010/03/05 APPR: JCOMERCI 2010/03/05	DESCRIPTION	GENERAL TOLERANCES (UNLESS SPECIFIED)		DIMENSION STYLE <b>INCH ONLY</b>		SCALE <b>4:1</b>	DESIGN UNITS <b>INCH</b>	THIRD ANGLE PROJECTION		
			mm	INCH	DRAWN BY T GREGORI	DATE 2005/01/27	<b>SEARAY  PLUG ASSEMBLY  .050 CENTERS</b>			
		4 PLACES	± ---	± ---	CHECKED BY JCOMERCI	DATE				
		3 PLACES	± ---	± .010	APPROVED BY JCOMERCI	DATE 2010/03/05				
		2 PLACES	± ---	± .015			 <b>MOLEX INCORPORATED</b>			
		1 PLACE	± ---	± ---			DOCUMENT NO. <b>SD-45970-001</b>	SHEET NO. <b>9 OF 10</b>		
DRAFT WHERE APPLICABLE MUST REMAIN WITHIN DIMENSIONS						<b>THIS DRAWING CONTAINS INFORMATION THAT IS PROPRIETARY TO MOLEX  INCORPORATED AND SHOULD NOT BE USED WITHOUT WRITTEN PERMISSION</b>				

D	TRAY PACK PK-45971-001	DIM P:		2.0 MM	3.0 MM	3.5 MM	2.5 MM	4.5 MM	5.0 MM	7.0 MM
		DIM R:		.221	.260	.280	.241	.319	.339	.418
		POSITION	DIM G	MATERIAL NO	MATERIAL NO	MATERIAL NO	MATERIAL NO	MATERIAL NO	MATERIAL NO	MATERIAL NO
		19	1.146	45970-0123	45970-0223	45970-0323	45970-0423	45970-0523	45970-0623	45970-0723
		10	0.696	45970-1123	45970-1223	45970-1323	45970-1423	45970-1523	45970-1623	45970-1723
		20	1.196	45970-2123	45970-2223	45970-2323	45970-2423	45970-2523	45970-2623	45970-2723
		30	1.696	45970-3123	45970-3223	45970-3323	45970-3423	45970-3523	45970-3623	45970-3723
		40	2.196	45970-4123	45970-4223	45970-4323	45970-4423	45970-4523	45970-4623	45970-4723
		50	2.696	45970-5123	45970-5223	45970-5323	45970-5423	45970-5523	45970-5623	45970-5723
		15	0.946	45970-6123	45970-6223	45970-6323	45970-6423	45970-6523	45970-6623	45970-6723
		25	1.446	45970-7123	45970-7223	45970-7323	45970-7423	45970-7523	45970-7623	45970-7723
		35	1.946	45970-8123	45970-8223	45970-8323	45970-8423	45970-8523	45970-8623	45970-8723
45	2.446	45970-9123	45970-9223	45970-9323	45970-9423	45970-9523	45970-9623	45970-9723		

C	TAPE AND REEL PACK PK-45971-002	DIM P:		2.0 MM	3.0 MM	3.5 MM	2.5 MM	4.5 MM	5.0 MM	7.0 MM
		DIM R:		.221	.260	.280	.241	.319	.339	.418
		POSITION	DIM G	MATERIAL NO	MATERIAL NO	MATERIAL NO	MATERIAL NO	MATERIAL NO	MATERIAL NO	MATERIAL NO
		19	1.146	45970-0127	45970-0227	45970-0327	45970-0427	45970-0527	45970-0627	45970-0727
		10	0.696	45970-1127	45970-1227	45970-1327	45970-1427	45970-1527	45970-1627	45970-1727
		20	1.196	45970-2127	45970-2227	45970-2327	45970-2427	45970-2527	45970-2627	45970-2727
		30	1.696	45970-3127	45970-3227	45970-3327	45970-3427	45970-3527	45970-3627	45970-3727
		40	2.196	45970-4127	45970-4227	45970-4327	45970-4427	45970-4527	45970-4627	45970-4727
		50	2.696	45970-5127	45970-5227	45970-5327	45970-5427	45970-5527	45970-5627	45970-5727
		15	0.946	45970-6127	45970-6227	45970-6327	45970-6427	45970-6527	45970-6627	45970-6727
		25	1.446	45970-7127	45970-7227	45970-7327	45970-7427	45970-7527	45970-7627	45970-7727
		35	1.946	45970-8127	45970-8227	45970-8327	45970-8427	45970-8527	45970-8627	45970-8727
45	2.446	45970-9127	45970-9227	45970-9327	45970-9427	45970-9527	45970-9627	45970-9727		

NOTES:  
 1. THIS SHEET CONTAINS THE FOLLOWING OPTIONS  
 ROWS: 12  
 SOLDER CHARGE: TIN / LEAD  
 PACKAGING: TRAYS AND TAPE AND REEL

SEE SHEET 1 EC NO: UCP2010-2270 DRWN: TGREGORI 2010/03/05 CHKD: JCOMERCI 2010/03/05 APPR: JCOMERCI 2010/03/05	DESCRIPTION REV	GENERAL TOLERANCES (UNLESS SPECIFIED)		DIMENSION STYLE <b>INCH ONLY</b>		SCALE <b>4:1</b>	DESIGN UNITS <b>INCH</b>	THIRD ANGLE PROJECTION		
			mm	INCH	DRAWN BY TGREGORI	DATE 2005/01/27	TITLE <b>SEARAY          PLUG ASSEMBLY          .050 CENTERS</b>			
		4 PLACES	± ---	± ---	CHECKED BY JCOMERCI	DATE				
		3 PLACES	± ---	± .010	APPROVED BY JCOMERCI	DATE 2010/03/05				
		2 PLACES	± ---	± .015	ANGULAR ± ---°		<b>MOLEX INCORPORATED</b>		DOCUMENT NO. <b>SD-45970-001</b>	SHEET NO. <b>10 OF 10</b>
1 PLACE	± ---	± ---	DRAFT WHERE APPLICABLE MUST REMAIN WITHIN DIMENSIONS		SIZE <b>A</b>	THIS DRAWING CONTAINS INFORMATION THAT IS PROPRIETARY TO MOLEX INCORPORATED AND SHOULD NOT BE USED WITHOUT WRITTEN PERMISSION				