

# Coaxial Frequency Mixer

Level 7 (LO Power +7 dBm) 1 to 1000 MHz

## ZFM-2+ ZFM-2



SMA version shown

CASE STYLE: K18

Connectors	Model
BNC	ZFM-2(+)
SMA	ZFM-2-S+

BRACKET (OPTION "B")

**+RoHS Compliant**

The +Suffix identifies RoHS Compliance. See our web site for RoHS Compliance methodologies and qualifications

### Maximum Ratings

Operating Temperature	-55°C to 100°C
Storage Temperature	-55°C to 100°C
RF Power	50mW
IF Current	40mA

Permanent damage may occur if any of these limits are exceeded.

### Coaxial Connections

LO	1
RF	2
IF	3

### Features

- low conversion loss, 5.72 dB typ.
- good L-R isolation, 40 dB typ, L-I, 35 dB typ.
- wideband, 1 to 1000
- rugged shielded case

### Applications

- VHF/UHF
- cellular
- instrumentation

### Outline Drawing

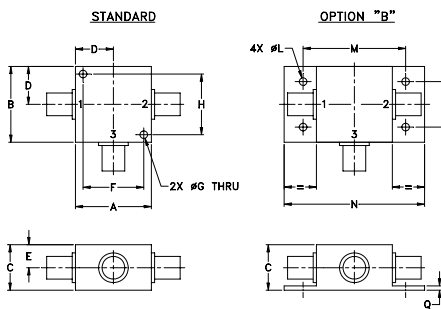

### Outline Dimensions (inch/mm)

A	B	C	D	E	F	G	H
1.25	1.25	.75	.63	.38	1.00	.125	1.000
31.75	31.75	19.05	16.00	9.65	25.40	3.18	25.40

J	K	L	M	N	P	Q	wt
--	--	.125	1.688	2.18	.75	.07	grams
--	--	3.18	42.88	55.37	19.05	1.78	70.0

### Electrical Specifications

FREQUENCY (MHz)	CONVERSION LOSS (dB)	LO-RF ISOLATION (dB)			LO-IF ISOLATION (dB)												
		L	M	U	L	M	U										
1-1000	DC-1000	5.72	0.06	7.5	8.5	50	45	40	25	30	25	45	40	35	25	25	20

1 dB COMP.: +1 dBm typ. L = low range [ $f_L$  to  $10 f_L$ ] M = mid range [ $10 f_L$  to  $f_U/2$ ] U = upper range [ $f_U/2$  to  $f_U$ ]  
m = mid band [ $2f_L$  to  $f_U/2$ ]

### Typical Performance Data

Frequency (MHz)	Conversion Loss (dB)	Isolation L-R (dB)	Isolation L-I (dB)	VSWR RF Port (:1)	VSWR LO Port (:1)
1.00	31.00	7.23	>67.00	1.30	2.70
2.00	32.00	6.50	>67.00	1.15	2.63
5.00	35.00	5.80	>67.00	1.07	2.77
10.00	40.00	5.62	>67.00	1.06	2.55
20.00	50.00	5.68	>67.00	1.07	2.41
50.00	80.00	5.58	61.94	1.09	2.37
100.00	70.00	5.53	54.33	1.11	2.29
167.34	137.34	5.57	48.65	1.16	2.20
233.87	203.87	5.72	45.10	1.18	2.16
300.40	270.40	5.45	42.56	1.20	2.13
366.94	336.94	5.73	40.45	1.22	2.06
466.74	436.74	5.82	38.33	1.23	2.13
500.00	470.00	5.72	38.80	1.26	2.09
599.81	569.81	6.02	37.43	1.29	2.09
666.34	636.34	6.11	37.94	1.34	2.04
799.41	769.41	6.27	36.06	1.40	2.13
832.68	802.68	6.46	35.22	1.47	2.19
899.21	869.21	7.00	33.77	1.55	2.24
932.48	902.48	7.37	33.17	1.66	2.28
1000.00	969.00	7.63	32.49	1.72	2.30

### Electrical Schematic

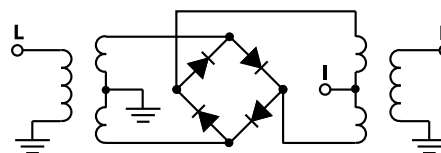

### Notes

- Performance and quality attributes and conditions not expressly stated in this specification document are intended to be excluded and do not form a part of this specification document.
- Electrical specifications and performance data contained in this specification document are based on Mini-Circuit's applicable established test performance criteria and measurement instructions.
- The parts covered by this specification document are subject to Mini-Circuits standard limited warranty and terms and conditions (collectively, "Standard Terms"); Purchasers of this part are entitled to the rights and benefits contained therein. For a full statement of the Standard Terms and the exclusive rights and remedies thereunder, please visit Mini-Circuits' website at [www.minicircuits.com/MCLStore/terms.jsp](http://www.minicircuits.com/MCLStore/terms.jsp)



## Performance Charts

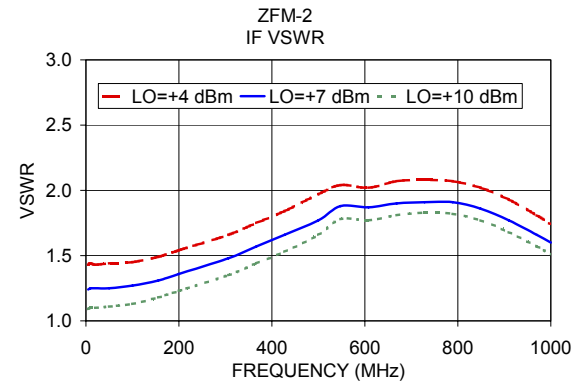
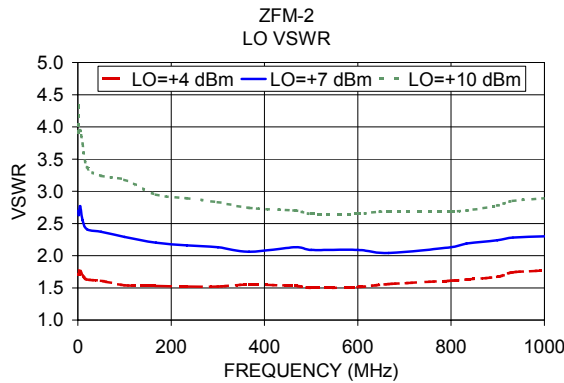
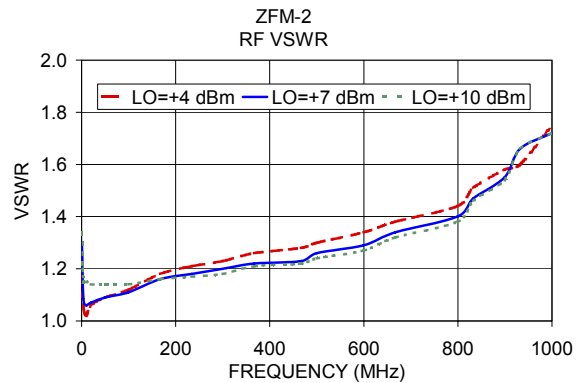
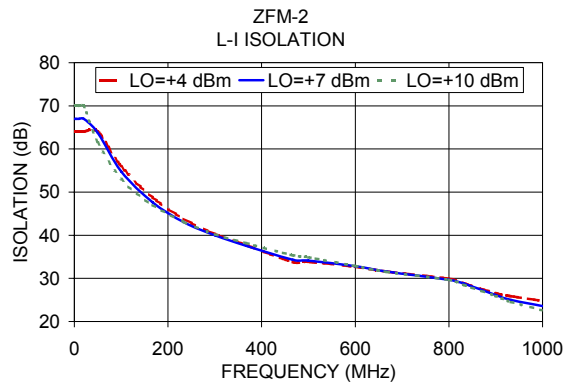
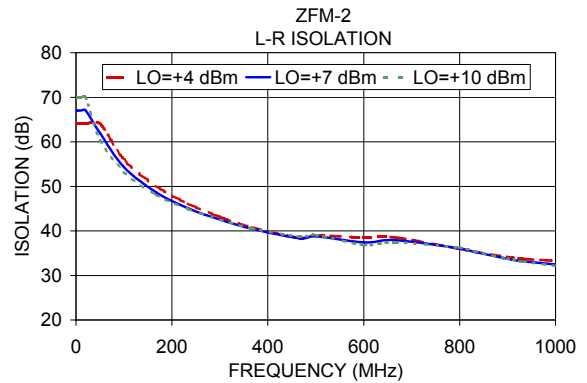
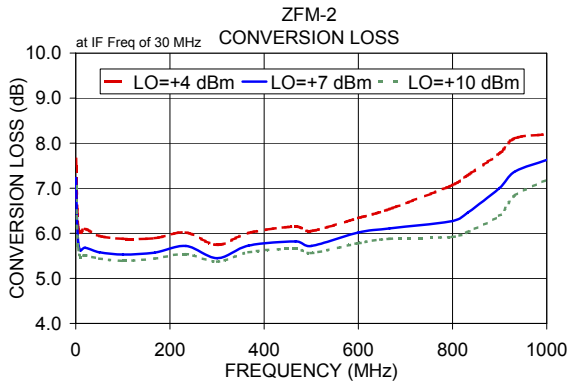

**Notes**

- A. Performance and quality attributes and conditions not expressly stated in this specification document are intended to be excluded and do not form a part of this specification document.
- B. Electrical specifications and performance data contained in this specification document are based on Mini-Circuit's applicable established test performance criteria and measurement instructions.
- C. The parts covered by this specification document are subject to Mini-Circuits standard limited warranty and terms and conditions (collectively, "Standard Terms"); Purchasers of this part are entitled to the rights and benefits contained therein. For a full statement of the Standard Terms and the exclusive rights and remedies thereunder, please visit Mini-Circuits' website at [www.minicircuits.com/MCLStore/terms.jsp](http://www.minicircuits.com/MCLStore/terms.jsp)

