

Part Number: KB2770YW

Yellow

Features

- UNIFORM LIGHT EMITTING AREA.
- LOW CURRENT OPERATION.
- EASILY MOUNTED ON P.C. BOARDS.
- FLUSH MOUNTABLE.
- EXCELLENT ON/OFF CONTRAST.
- CAN BE USED WITH PANELS AND LEGEND MOUNTS.
- CATEGORIZED FOR LUMINOUS INTENSITY, YELLOW AND GREEN CATEGORIZED FOR COLOR.
- RoHS COMPLIANT.

Description

The Yellow source color devices are made with Gallium Arsenide Phosphide on Gallium Phosphide Yellow Light Emitting Diode.

Package Dimensions & Internal Circuit Diagram

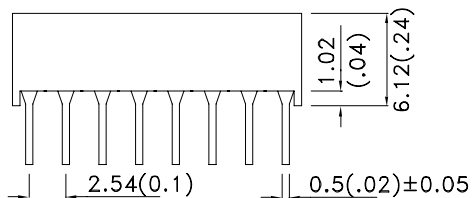
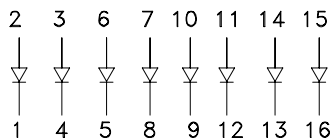
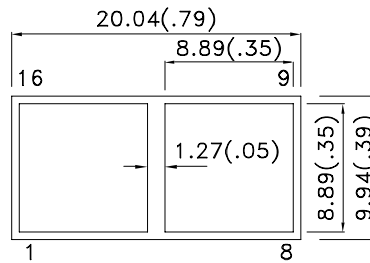
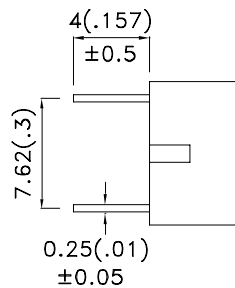

Notes:

1. All dimensions are in millimeters (inches), Tolerance is ±0.25(0.01") unless otherwise noted.
2. Specifications are subject to change without notice.



Selection Guide

| Part No. | Dice | Lens Type | Iv (mcd) [1] @ 20mA | |
|----------|--------------------|----------------|------------------------|------|
| | | | Min. | Typ. |
| KB2770YW | Yellow (GaAsP/GaP) | WHITE DIFFUSED | 10 | 50 |

Note:

1. Luminous intensity/ luminous Flux: +/-15%.

Electrical / Optical Characteristics at TA=25°C

| Symbol | Parameter | Device | Typ. | Max. | Units | Test Conditions |
|-----------------------|--------------------------|--------|------|------|-------|---------------------------|
| λ_{peak} | Peak Wavelength | Yellow | 590 | | nm | I _F =20mA |
| λ_D [1] | Dominant Wavelength | Yellow | 588 | | nm | I _F =20mA |
| $\Delta\lambda_{1/2}$ | Spectral Line Half-width | Yellow | 35 | | nm | I _F =20mA |
| C | Capacitance | Yellow | 20 | | pF | V _F =0V;f=1MHz |
| V _F [2] | Forward Voltage | Yellow | 2.1 | 2.5 | V | I _F =20mA |
| I _R | Reverse Current | Yellow | | 10 | uA | V _R =5V |

Notes:

1. Wavelength: +/-1nm.

2. Forward Voltage: +/-0.1V.

Absolute Maximum Ratings at TA=25°C

| Parameter | Yellow | Units |
|---------------------------------|-----------------------|-------|
| Power dissipation | 75 | mW |
| DC Forward Current | 30 | mA |
| Peak Forward Current [1] | 140 | mA |
| Reverse Voltage | 5 | V |
| Operating / Storage Temperature | -40°C To +85°C | |
| Lead Solder Temperature[2] | 260°C For 3-5 Seconds | |

Notes:

1. 1/10 Duty Cycle, 0.1ms Pulse Width.

2. 2mm below package base.

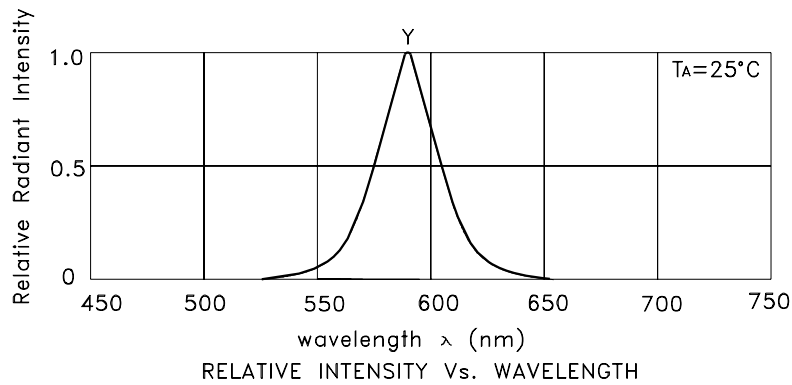

Yellow

KB2770YW

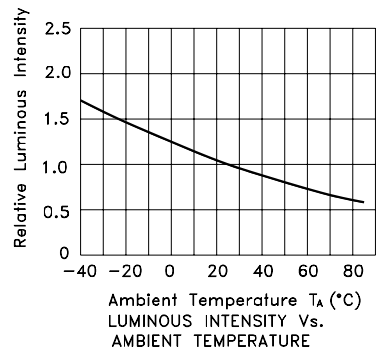
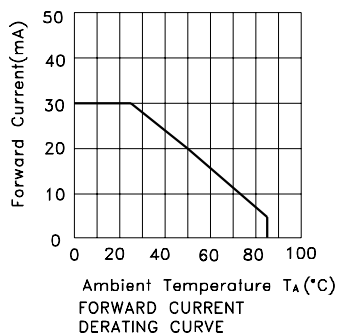
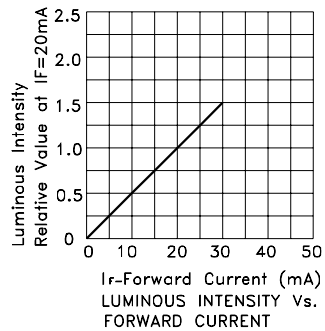
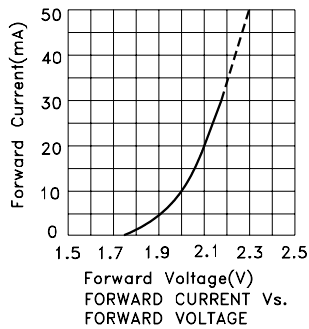

PACKING & LABEL SPECIFICATIONS

KB2770YW

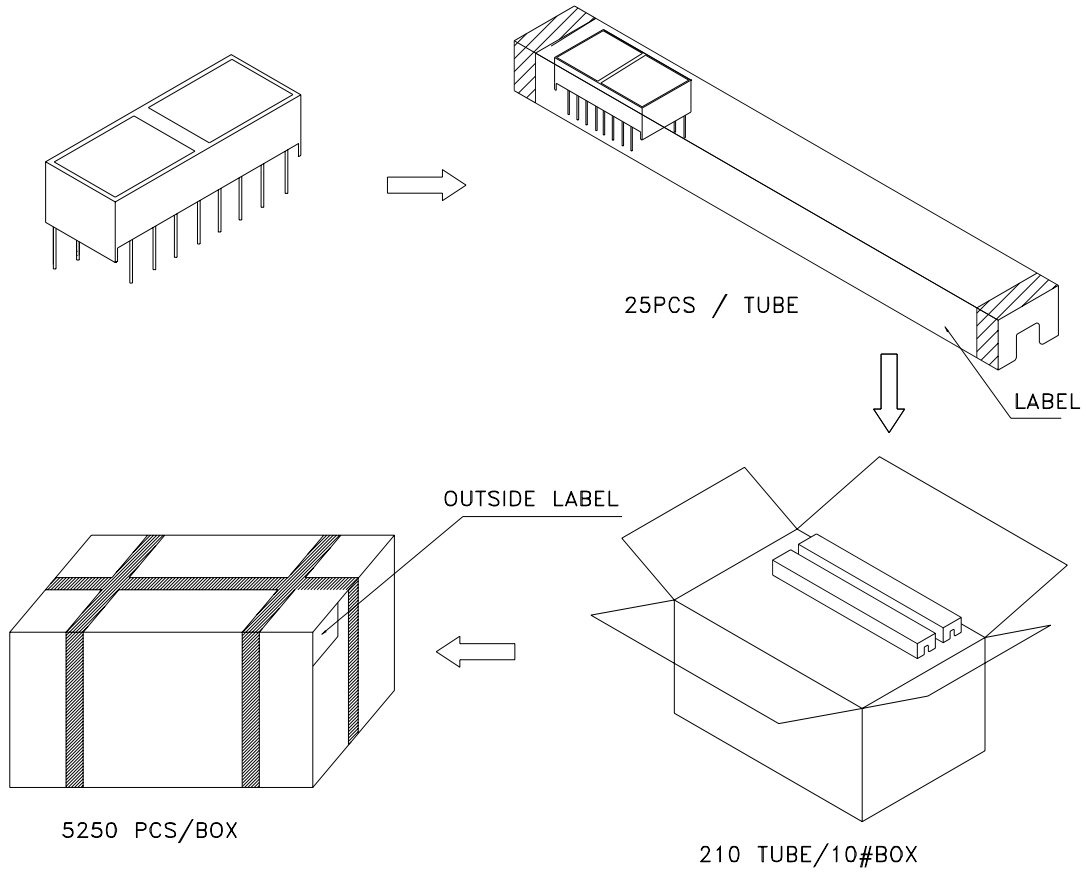

Inside LABEL Paste On The IC-tube

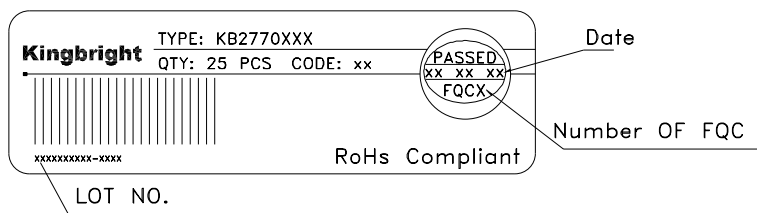

Outside LABEL Paste On The Box

