

**TPS76815-Q1, TPS76818-Q1, TPS76825-Q1, TPS76827-Q1
TPS76828-Q1, TPS76830-Q1, TPS76833-Q1, TPS76850-Q1, TPS76801-Q1
FAST-TRANSIENT-RESPONSE 1-A LOW-DROPOUT VOLTAGE REGULATORS**

SGLS155A – FEBRUARY 2003 – REVISED SEPTEMBER 2008

- **Qualified for Automotive Applications**
- **ESD Protection Exceeds 2000 V Per MIL-STD-883, Method 3015; Exceeds 200 V Using Machine Model (C = 200 pF, R = 0)**
- **1-A Low-Dropout Voltage Regulator**
- **Available in 1.5-V, 1.8-V, 2.5-V, 2.7-V, 2.8-V, 3.0-V, 3.3-V, 5.0-V Fixed Output and Adjustable Versions**
- **Dropout Voltage Down to 230 mV at 1 A (TPS76850)**
- **Ultralow 85- μ A Typical Quiescent Current**
- **Fast Transient Response**
- **2% Tolerance Over Specified Conditions for Fixed-Output Versions**
- **Open-Drain Power Good (See TPS767xx for Power-On Reset With 200-ms Delay Option)**
- **20-Pin TSSOP (PWP) Package**
- **Thermal Shutdown Protection**

**PWP PACKAGE
(TOP VIEW)**

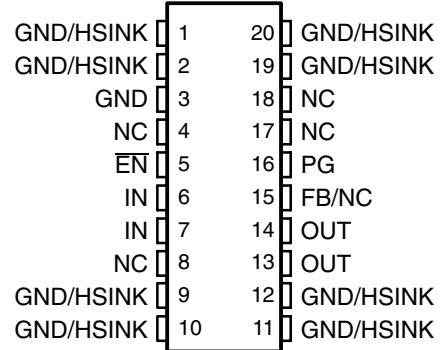

NC – No internal connection

description

This device is designed to have a fast transient response and be stable with 10- μ F low ESR capacitors. This combination provides high performance at a reasonable cost.

Because the PMOS device behaves as a low-value resistor, the dropout voltage is very low (typically 230 mV at an output current of 1 A for the TPS76850) and is directly proportional to the output current. Additionally, since the PMOS pass element is a voltage-driven device, the quiescent current is very low and independent of output loading (typically 85 μ A over the full range of output current, 0 mA to 1 A). These two key specifications yield a significant improvement in operating life for battery-powered systems. This LDO family also features a sleep mode; applying a TTL high signal to EN (enable) shuts down the regulator, reducing the quiescent current to less than 1 μ A at $T_J = 25^\circ\text{C}$.

Power good (PG) is an active high output, which can be used to implement a power-on reset or a low-battery indicator.

The TPS768xx is offered in 1.5-V, 1.8-V, 2.5-V, 2.7-V, 2.8-V, 3.0-V, 3.3-V, and 5.0-V fixed-voltage versions and in an adjustable version (programmable over the range of 1.2 V to 5.5 V). Output voltage tolerance is specified as a maximum of 2% over line, load, and temperature ranges. The TPS768xx family is available in a 20-pin PWP package.



Please be aware that an important notice concerning availability, standard warranty, and use in critical applications of Texas Instruments semiconductor products and disclaimers thereto appears at the end of this data sheet.

PRODUCTION DATA information is current as of publication date. Products conform to specifications per the terms of Texas Instruments standard warranty. Production processing does not necessarily include testing of all parameters.



POST OFFICE BOX 655303 • DALLAS, TEXAS 75265

Copyright © 2008, Texas Instruments Incorporated

**TPS76815-Q1, TPS76818-Q1, TPS76825-Q1, TPS76827-Q1
 TPS76828-Q1, TPS76830-Q1, TPS76833-Q1, TPS76850-Q1, TPS76801-Q1
 FAST-TRANSIENT-RESPONSE 1-A LOW-DROPOUT VOLTAGE REGULATORS**

SGLS155A – FEBRUARY 2003 – REVISED SEPTEMBER 2008

description (continued)

**TPS76833
 DROPOUT VOLTAGE**

**VS
 FREE-AIR TEMPERATURE**

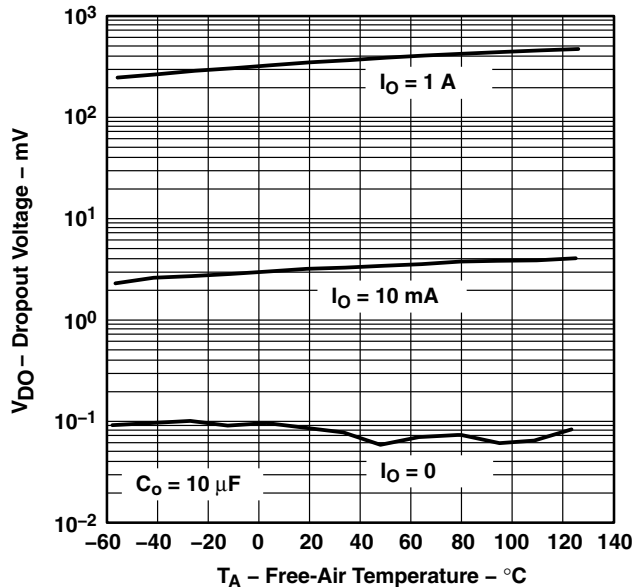

LOAD TRANSIENT RESPONSE

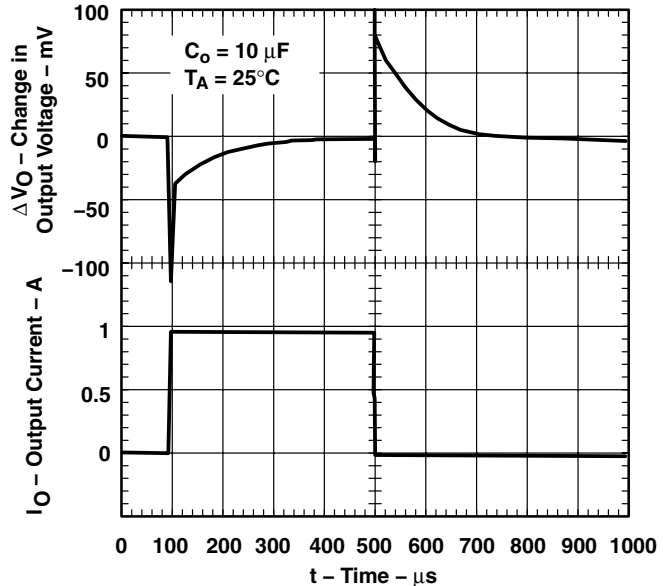

ORDERING INFORMATION†

T _J	OUTPUT VOLTAGE (V)	PACKAGE‡		ORDERABLE PART NUMBER	TOP-SIDE MARKING
	TYP				
-40°C to 125°C	5.0	TSSOP - PWP	Tape and reel	TPS76850QPWPRQ1	76850Q1
	3.3			TPS76833QPWPRQ1	76833Q1
	3.0			TPS76830QPWPRQ1§	76830Q1§
	2.8			TPS76828QPWPRQ1§	76828Q1§
	2.7			TPS76827QPWPRQ1§	76827Q1§
	2.5			TPS76825QPWPRQ1	76825Q1
	1.8			TPS76818QPWPRQ1	76818Q1
	1.5			TPS76815QPWPRQ1	76815Q1
	Adjustable 1.2 V to 5.5 V			TPS76801QPWPRQ1	76801Q1

† For the most current package and ordering information, see the Package Option Addendum at the end of this document, or see the TI web site at <http://www.ti.com>.

‡ Package drawings, thermal data, and symbolization are available at <http://www.ti.com/packaging>.

§ This device is Product Preview.

The TPS76801 is programmable using an external resistor divider (see application information). The PWP package is available taped and reeled. Note R suffix to the device type (e.g., TPS76801QPWPRQ1).



**TPS76815-Q1, TPS76818-Q1, TPS76825-Q1, TPS76827-Q1
 TPS76828-Q1, TPS76830-Q1, TPS76833-Q1, TPS76850-Q1, TPS76801-Q1
 FAST-TRANSIENT-RESPONSE 1-A LOW-DROPOUT VOLTAGE REGULATORS**

SGLS155A – FEBRUARY 2003 – REVISED SEPTEMBER 2008

description (continued)

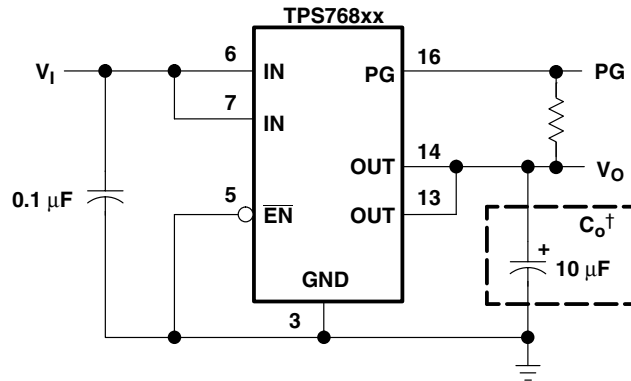

† See application information section for capacitor selection details.

Figure 1. Typical Application Configuration (For Fixed Output Options)

functional block diagram—adjustable version

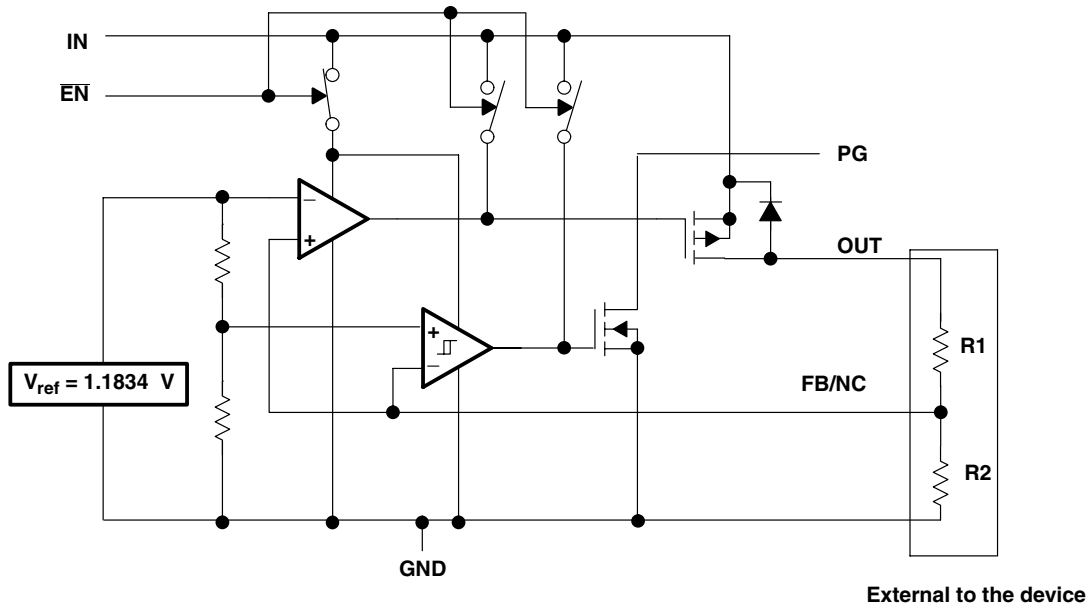

**TPS76815-Q1, TPS76818-Q1, TPS76825-Q1, TPS76827-Q1
 TPS76828-Q1, TPS76830-Q1, TPS76833-Q1, TPS76850-Q1, TPS76801-Q1
 FAST-TRANSIENT-RESPONSE 1-A LOW-DROPOUT VOLTAGE REGULATORS**

SGLS155A – FEBRUARY 2003 – REVISED SEPTEMBER 2008

absolute maximum ratings over operating free-air temperature range (unless otherwise noted)[†]

Input voltage range [‡] , V_I	-0.3 V to 13.5 V
Voltage range at \overline{EN}	-0.3 V to $V_I + 0.3$ V
Maximum PG voltage	16.5 V
Peak output current	Internally limited
Continuous total power dissipation	See dissipation rating tables
Output voltage, V_O (OUT, FB)	7 V
Thermal impedance, Junction-to-Air, Θ_{JA}	42.55°C/W
Operating virtual junction temperature range, T_J	-40°C to 150°C
Storage temperature range, T_{stg}	-65°C to 150°C
ESD rating, HBM	2 kV

[†] Stresses beyond those listed under “absolute maximum ratings” may cause permanent damage to the device. These are stress ratings only, and functional operation of the device at these or any other conditions beyond those indicated under “recommended operating conditions” is not implied. Exposure to absolute-maximum-rated conditions for extended periods may affect device reliability.

[‡] All voltage values are with respect to network terminal ground.

recommended operating conditions

	MIN	MAX	UNIT
Input voltage, V_I [§]	2.7	10	V
Output voltage range, V_O	1.2	5.5	V
Output current, I_O (see Note 1)	0	1.0	A
Operating virtual junction temperature, T_J (see Note 1)	-40	125	°C

[§] To calculate the minimum input voltage for your maximum output current, use the following equation: $V_{I(min)} = V_{O(max)} + V_{DO(max\ load)}$.

NOTE 1: Continuous current and operating junction temperature are limited by internal protection circuitry, but it is not recommended that the device operate under conditions beyond those specified in this table for extended periods of time.



**TPS76815-Q1, TPS76818-Q1, TPS76825-Q1, TPS76827-Q1
 TPS76828-Q1, TPS76830-Q1, TPS76833-Q1, TPS76850-Q1, TPS76801-Q1
 FAST-TRANSIENT-RESPONSE 1-A LOW-DROPOUT VOLTAGE REGULATORS**

SGLS155A – FEBRUARY 2003 – REVISED SEPTEMBER 2008

**electrical characteristics over recommended operating free-air temperature range,
 $V_I = V_{O(typ)} + 1\text{ V}$, $I_O = 1\text{ mA}$, $\overline{EN} = 0\text{ V}$, $C_O = 10\text{ }\mu\text{F}$ (unless otherwise noted)**

PARAMETER		TEST CONDITIONS	MIN	TYP	MAX	UNIT
Output voltage (10 μA to 1 A load) (see Note 2)	TPS76801	$5.5\text{ V} \geq V_O \geq 1.5\text{ V}$, $T_J = 25^\circ\text{C}$		V_O		V
		$5.5\text{ V} \geq V_O \geq 1.5\text{ V}$, $T_J = -40^\circ\text{C to } 125^\circ\text{C}$	0.98 V_O		1.02 V_O	
	TPS76815	$T_J = 25^\circ\text{C}$, $2.7\text{ V} < V_{IN} < 10\text{ V}$		1.5		
		$T_J = -40^\circ\text{C to } 125^\circ\text{C}$, $2.7\text{ V} < V_{IN} < 10\text{ V}$	1.470		1.530	
	TPS76818	$T_J = 25^\circ\text{C}$, $2.8\text{ V} < V_{IN} < 10\text{ V}$		1.8		
		$T_J = -40^\circ\text{C to } 125^\circ\text{C}$, $2.8\text{ V} < V_{IN} < 10\text{ V}$	1.764		1.836	
	TPS76825	$T_J = 25^\circ\text{C}$, $3.5\text{ V} < V_{IN} < 10\text{ V}$		2.5		
		$T_J = -40^\circ\text{C to } 125^\circ\text{C}$, $3.5\text{ V} < V_{IN} < 10\text{ V}$	2.450		2.550	
	TPS76827	$T_J = 25^\circ\text{C}$, $3.7\text{ V} < V_{IN} < 10\text{ V}$		2.7		
		$T_J = -40^\circ\text{C to } 125^\circ\text{C}$, $3.7\text{ V} < V_{IN} < 10\text{ V}$	2.646		2.754	
	TPS76828	$T_J = 25^\circ\text{C}$, $3.8\text{ V} < V_{IN} < 10\text{ V}$		2.8		
		$T_J = -40^\circ\text{C to } 125^\circ\text{C}$, $3.8\text{ V} < V_{IN} < 10\text{ V}$	2.744		2.856	
	TPS76830	$T_J = 25^\circ\text{C}$, $4\text{ V} < V_{IN} < 10\text{ V}$		3.0		
		$T_J = -40^\circ\text{C to } 125^\circ\text{C}$, $4\text{ V} < V_{IN} < 10\text{ V}$	2.940		3.060	
	TPS76833	$T_J = 25^\circ\text{C}$, $4.3\text{ V} < V_{IN} < 10\text{ V}$		3.3		
		$T_J = -40^\circ\text{C to } 125^\circ\text{C}$, $4.3\text{ V} < V_{IN} < 10\text{ V}$	3.234		3.366	
	TPS76850	$T_J = 25^\circ\text{C}$, $6\text{ V} < V_{IN} < 10\text{ V}$		5.0		
		$T_J = -40^\circ\text{C to } 125^\circ\text{C}$, $6\text{ V} < V_{IN} < 10\text{ V}$	4.900		5.100	
Quiescent current (GND current) $\overline{EN} = 0\text{ V}$, (see Note 2)		$10\text{ }\mu\text{A} < I_O < 1\text{ A}$, $T_J = 25^\circ\text{C}$		85		μA
		$I_O = 1\text{ A}$, $T_J = -40^\circ\text{C to } 125^\circ\text{C}$			125	
Output voltage line regulation ($\Delta V_O/V_O$) (see Notes 2 and 3)		$V_O + 1\text{ V} < V_I \leq 10\text{ V}$, $T_J = 25^\circ\text{C}$		0.01		%/V
Load regulation				3		mV
Output noise voltage (TPS76818)		BW = 200 Hz to 100 kHz, $C_O = 10\text{ }\mu\text{F}$, $I_C = 1\text{ A}$, $T_J = 25^\circ\text{C}$		55		μVrms
Output current limit		$V_O = 0\text{ V}$		1.7	2	A
Thermal shutdown junction temperature				150		$^\circ\text{C}$
Standby current		$\overline{EN} = V_I$, $T_J = 25^\circ\text{C}$, $2.7\text{ V} < V_I < 10\text{ V}$		1		μA
		$\overline{EN} = V_I$, $T_J = -40^\circ\text{C to } 125^\circ\text{C}$, $2.7\text{ V} < V_I < 10\text{ V}$			10	μA
FB input current	TPS76801	$FB = 1.5\text{ V}$		2		nA
High level enable input voltage				1.7		V
Low level enable input voltage					0.9	V
Power supply ripple rejection (see Note 2)		$f = 1\text{ KHz}$, $C_O = 10\text{ }\mu\text{F}$, $T_J = 25^\circ\text{C}$		60		dB

NOTES: 2. Minimum IN operating voltage is 2.7 V or $V_{O(typ)} + 1\text{ V}$, whichever is greater. Maximum IN voltage 10 V.

3. If $V_O \leq 1.8\text{ V}$ then $V_{I\text{max}} = 10\text{ V}$, $V_{I\text{min}} = 2.7\text{ V}$:

$$\text{Line Reg. (mV)} = (\%/V) \times \frac{V_O(V_{I\text{max}} - 2.7\text{ V})}{100} \times 1000$$

If $V_O \geq 2.5\text{ V}$ then $V_{I\text{max}} = 10\text{ V}$, $V_{I\text{min}} = V_O + 1\text{ V}$:

$$\text{Line Reg. (mV)} = (\%/V) \times \frac{V_O(V_{I\text{max}} - (V_O + 1\text{ V}))}{100} \times 1000$$



**TPS76815-Q1, TPS76818-Q1, TPS76825-Q1, TPS76827-Q1
TPS76828-Q1, TPS76830-Q1, TPS76833-Q1, TPS76850-Q1, TPS76801-Q1
FAST-TRANSIENT-RESPONSE 1-A LOW-DROPOUT VOLTAGE REGULATORS**

SGLS155A – FEBRUARY 2003 – REVISED SEPTEMBER 2008

**electrical characteristics over recommended operating free-air temperature range,
 $V_I = V_{O(\text{typ})} + 1 \text{ V}$, $I_O = 1 \text{ mA}$, $\overline{\text{EN}} = 0 \text{ V}$, $C_O = 10 \mu\text{F}$ (unless otherwise noted) (continued)**

PARAMETER		TEST CONDITIONS	MIN	TYP	MAX	UNIT
PG	Minimum input voltage for valid PG	$I_{O(\text{PG})} = 300 \mu\text{A}$		1.1		V
	Trip threshold voltage	V_O decreasing	92		98	% V_O
	Hysteresis voltage	Measured at V_O		0.5		% V_O
	Output low voltage	$V_I = 2.7 \text{ V}$, $I_{O(\text{PG})} = 1 \text{ mA}$		0.15	0.4	V
	Leakage current	$V_{(\text{PG})} = 5 \text{ V}$			1	μA
Input current ($\overline{\text{EN}}$)		$\overline{\text{EN}} = 0 \text{ V}$	-1	0	1	μA
		$\overline{\text{EN}} = V_I$	-1		1	
Dropout voltage (see Note 4)		TPS76828	$I_O = 1 \text{ A}$, $T_J = 25^\circ\text{C}$		500	mV
			$I_O = 1 \text{ A}$, $T_J = -40^\circ\text{C to } 125^\circ\text{C}$		825	
		TPS76830	$I_O = 1 \text{ A}$, $T_J = 25^\circ\text{C}$		450	
			$I_O = 1 \text{ A}$, $T_J = -40^\circ\text{C to } 125^\circ\text{C}$		675	
		TPS76833	$I_O = 1 \text{ A}$, $T_J = 25^\circ\text{C}$		350	
			$I_O = 1 \text{ A}$, $T_J = -40^\circ\text{C to } 125^\circ\text{C}$		575	
		TPS76850	$I_O = 1 \text{ A}$, $T_J = 25^\circ\text{C}$		230	
			$I_O = 1 \text{ A}$, $T_J = -40^\circ\text{C to } 125^\circ\text{C}$		380	

NOTE 4: I_N voltage equals $V_O(\text{typ}) - 100 \text{ mV}$; TPS76801 output voltage set to 3.3 V nominal with external resistor divider. TPS76815, TPS76818, TPS76825, and TPS76827 dropout voltage limited by input voltage range limitations (i.e., TPS76830 input voltage needs to drop to 2.9 V for purpose of this test).

TYPICAL CHARACTERISTICS

Table of Graphs

			FIGURE
V_O	Output voltage	vs Output current	2, 3, 4
		vs Free-air temperature	5, 6, 7
	Ground current	vs Free-air temperature	8, 9
	Power supply ripple rejection	vs Frequency	10
	Output spectral noise density	vs Frequency	11
	Input voltage (min)	vs Output voltage	12
Z_o	Output impedance	vs Frequency	13
V_{DO}	Dropout voltage	vs Free-air temperature	14
	Line transient response		15, 17
	Load transient response		16, 18
V_O	Output voltage	vs Time	19
	Dropout voltage	vs Input voltage	20
	Equivalent series resistance (ESR)	vs Output current	22 – 25



**TPS76815-Q1, TPS76818-Q1, TPS76825-Q1, TPS76827-Q1
 TPS76828-Q1, TPS76830-Q1, TPS76833-Q1, TPS76850-Q1, TPS76801-Q1
 FAST-TRANSIENT-RESPONSE 1-A LOW-DROPOUT VOLTAGE REGULATORS**

SGLS155A – FEBRUARY 2003 – REVISED SEPTEMBER 2008

TYPICAL CHARACTERISTICS

**TPS76833
 OUTPUT VOLTAGE
 vs
 OUTPUT CURRENT**

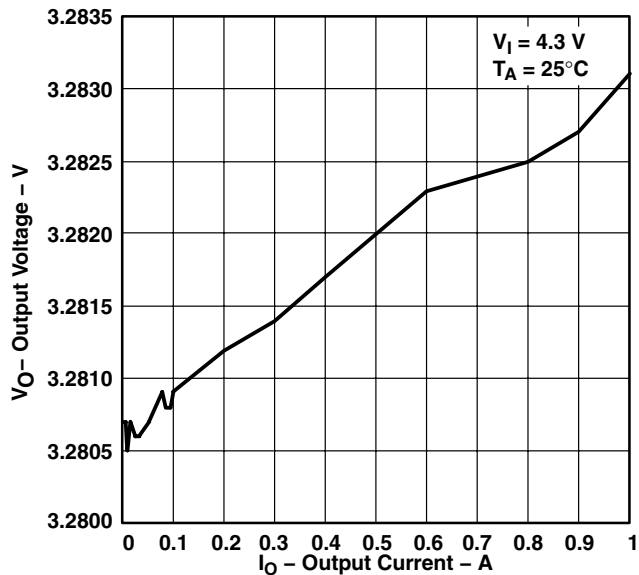

Figure 2

**TPS76815
 OUTPUT VOLTAGE
 vs
 OUTPUT CURRENT**

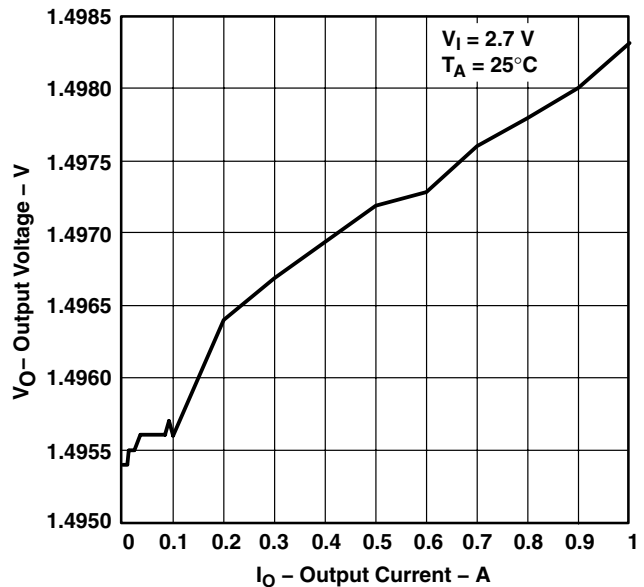

Figure 3

**TPS76825
 OUTPUT VOLTAGE
 vs
 OUTPUT CURRENT**

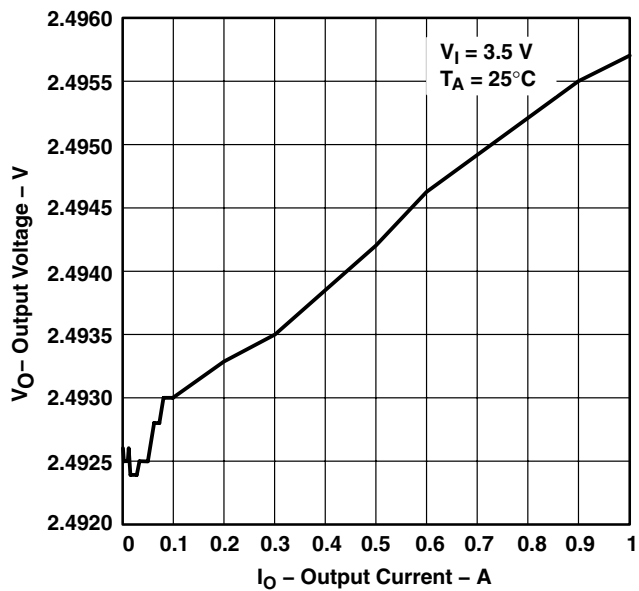

Figure 4

**TPS76833
 OUTPUT VOLTAGE
 vs
 FREE-AIR TEMPERATURE**

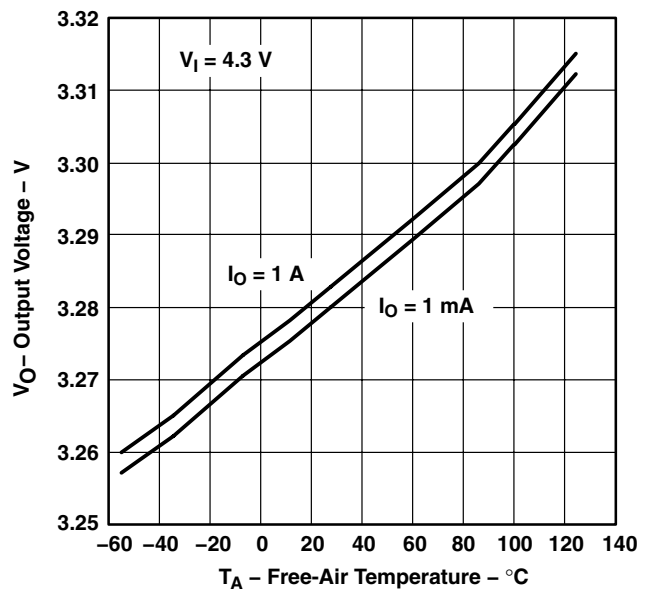

Figure 5



**TPS76815-Q1, TPS76818-Q1, TPS76825-Q1, TPS76827-Q1
 TPS76828-Q1, TPS76830-Q1, TPS76833-Q1, TPS76850-Q1, TPS76801-Q1
 FAST-TRANSIENT-RESPONSE 1-A LOW-DROPOUT VOLTAGE REGULATORS**

SGLS155A – FEBRUARY 2003 – REVISED SEPTEMBER 2008

TYPICAL CHARACTERISTICS

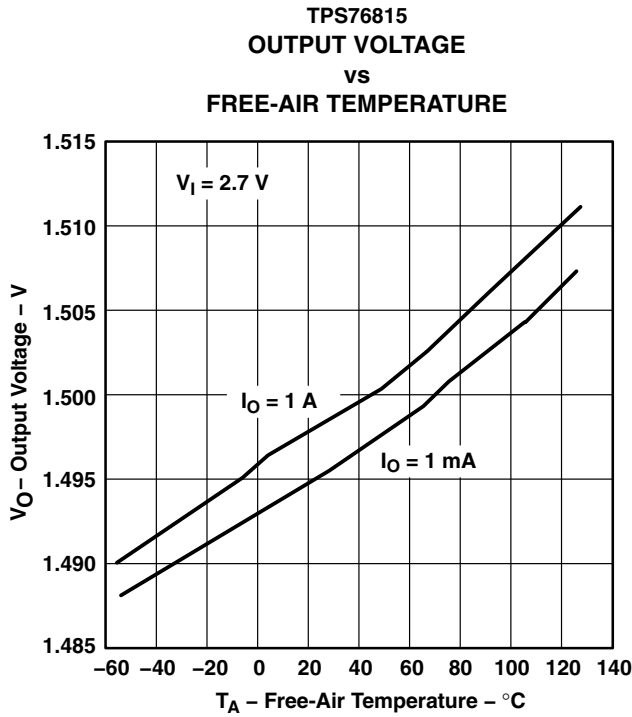

Figure 6

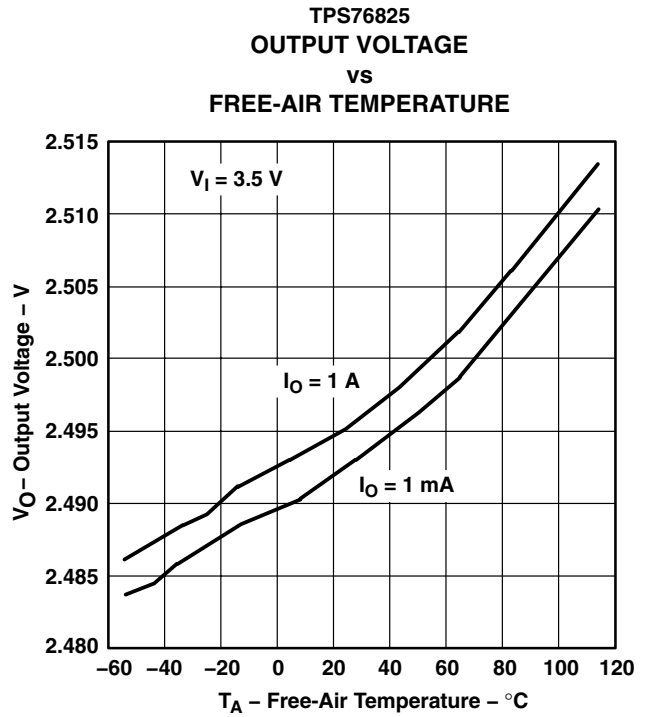

Figure 7

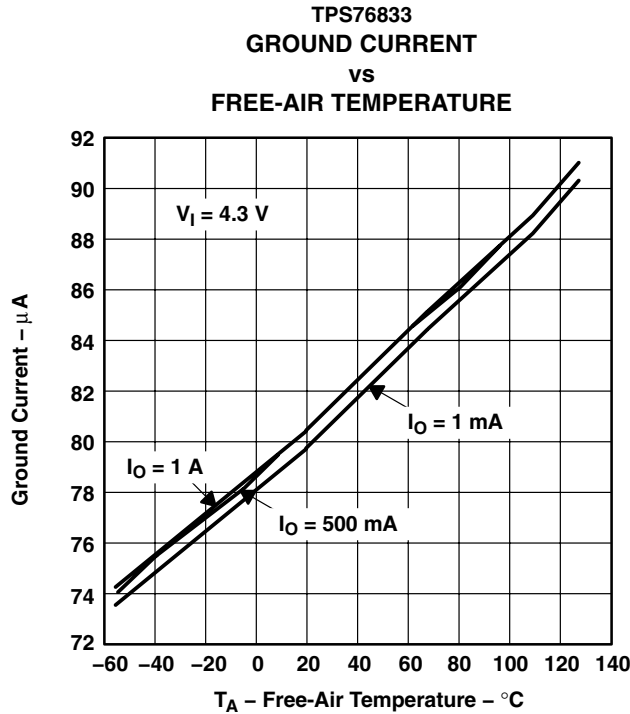

Figure 8



**TPS76815-Q1, TPS76818-Q1, TPS76825-Q1, TPS76827-Q1
 TPS76828-Q1, TPS76830-Q1, TPS76833-Q1, TPS76850-Q1, TPS76801-Q1
 FAST-TRANSIENT-RESPONSE 1-A LOW-DROPOUT VOLTAGE REGULATORS**

SGLS155A – FEBRUARY 2003 – REVISED SEPTEMBER 2008

TYPICAL CHARACTERISTICS

**TPS76815
 GROUND CURRENT
 vs
 FREE-AIR TEMPERATURE**

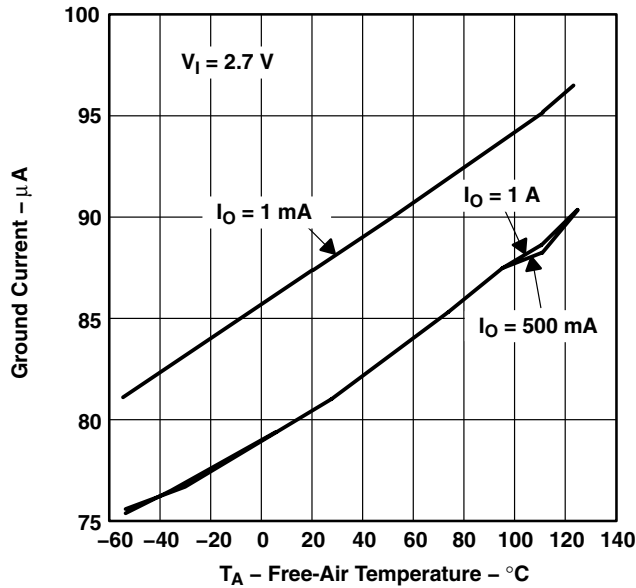

Figure 9

**TPS76833
 POWER SUPPLY RIPPLE REJECTION
 vs
 FREQUENCY**

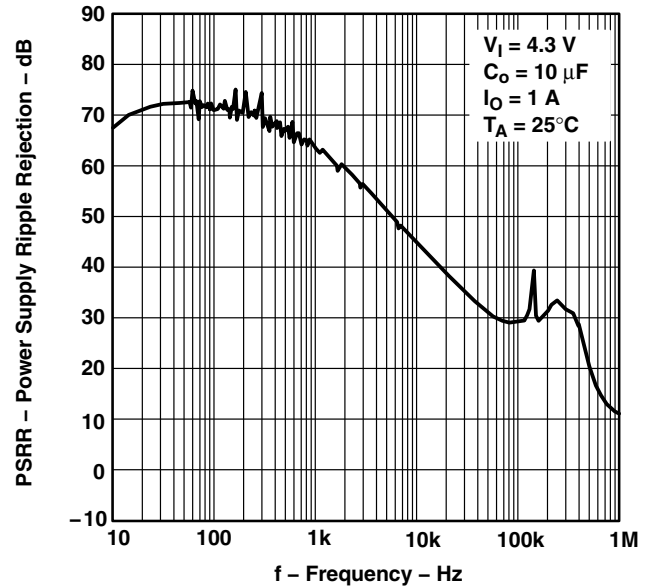

Figure 10

**TPS76833
 OUTPUT SPECTRAL NOISE DENSITY
 vs
 FREQUENCY**

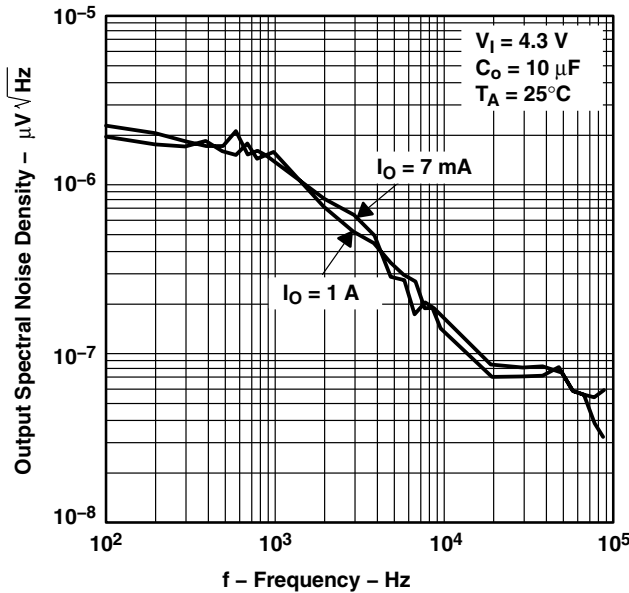

Figure 11



**TPS76815-Q1, TPS76818-Q1, TPS76825-Q1, TPS76827-Q1
 TPS76828-Q1, TPS76830-Q1, TPS76833-Q1, TPS76850-Q1, TPS76801-Q1
 FAST-TRANSIENT-RESPONSE 1-A LOW-DROPOUT VOLTAGE REGULATORS**

SGLS155A – FEBRUARY 2003 – REVISED SEPTEMBER 2008

TYPICAL CHARACTERISTICS

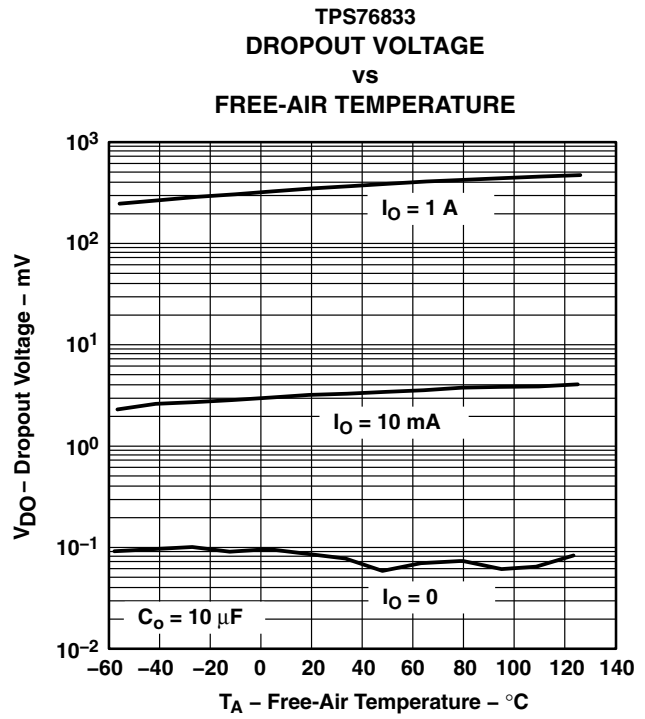
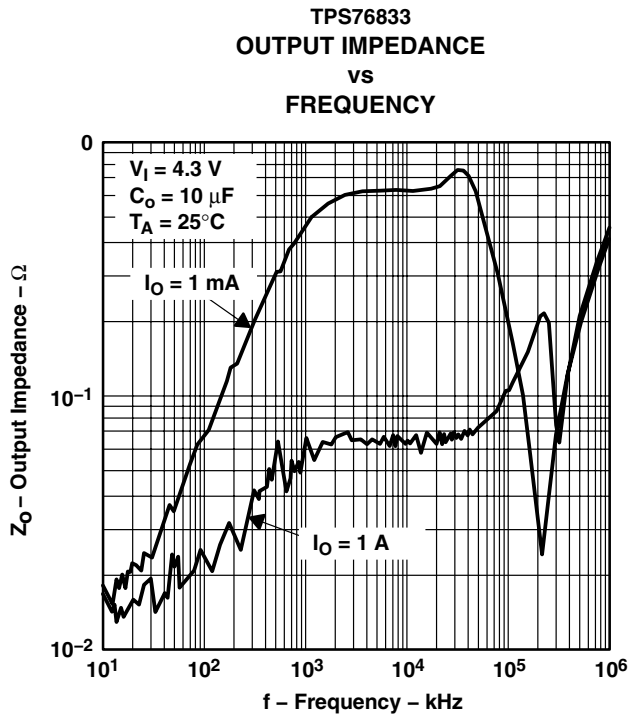
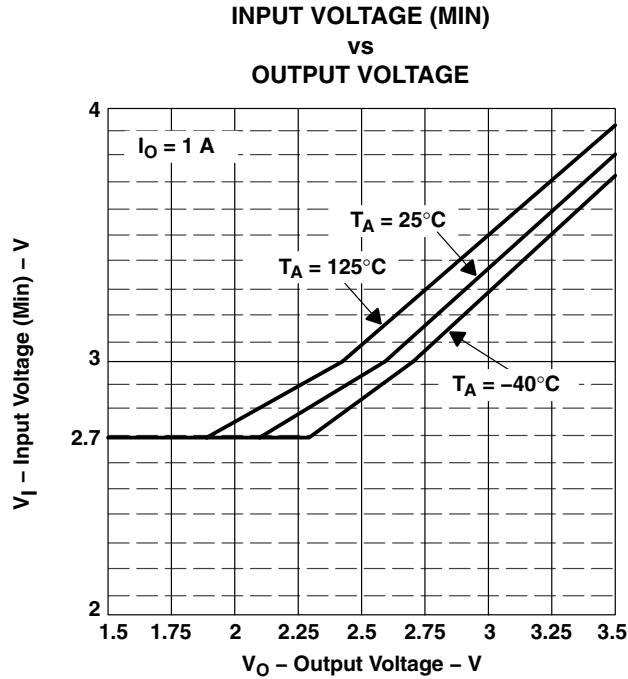

**TPS76815-Q1, TPS76818-Q1, TPS76825-Q1, TPS76827-Q1
 TPS76828-Q1, TPS76830-Q1, TPS76833-Q1, TPS76850-Q1, TPS76801-Q1
 FAST-TRANSIENT-RESPONSE 1-A LOW-DROPOUT VOLTAGE REGULATORS**

SGLS155A – FEBRUARY 2003 – REVISED SEPTEMBER 2008

TYPICAL CHARACTERISTICS

**TPS76815
 LINE TRANSIENT RESPONSE**

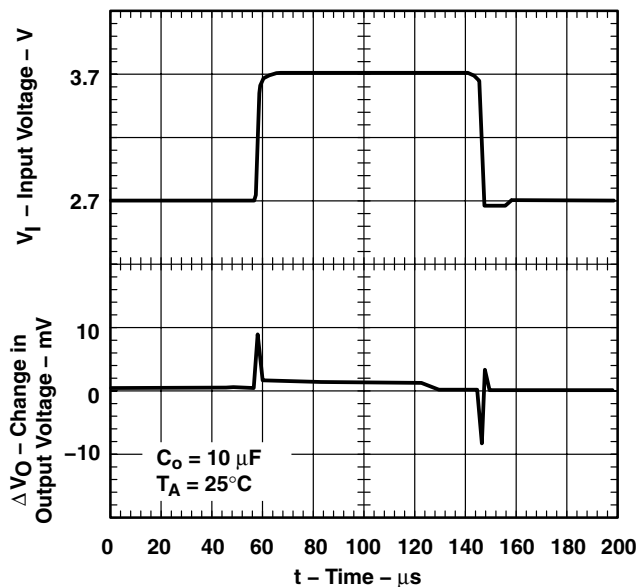

Figure 15

**TPS76815
 LOAD TRANSIENT RESPONSE**

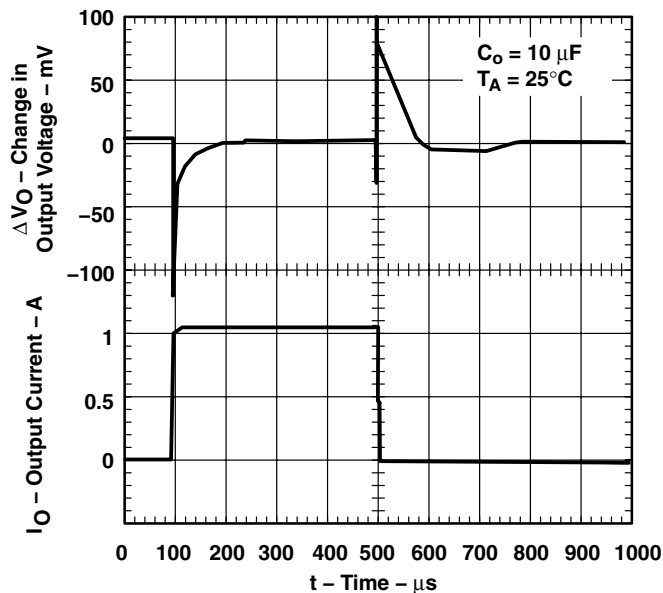

Figure 16

**TPS76833
 LINE TRANSIENT RESPONSE**

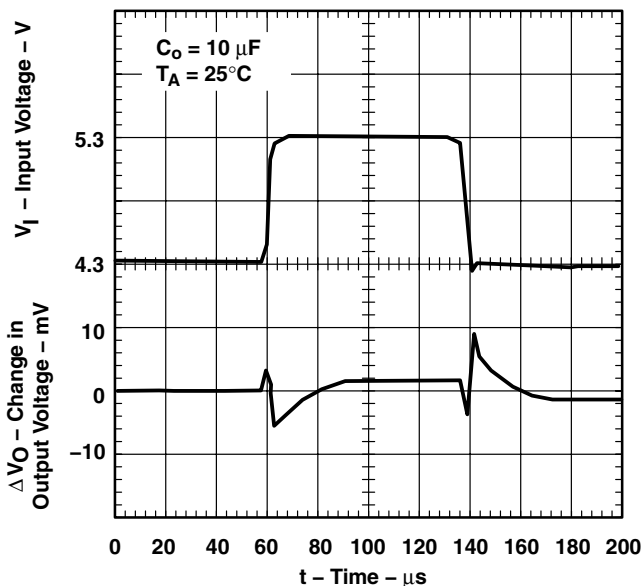

Figure 17

**TPS76833
 LOAD TRANSIENT RESPONSE**

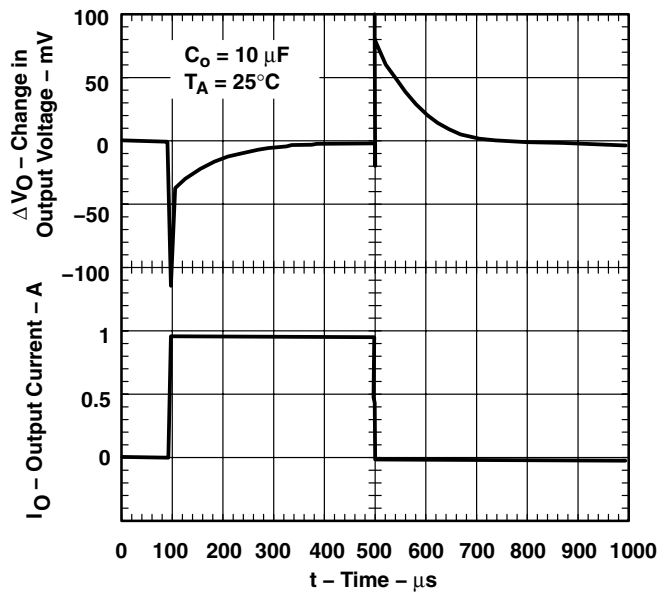

Figure 18



**TPS76815-Q1, TPS76818-Q1, TPS76825-Q1, TPS76827-Q1
 TPS76828-Q1, TPS76830-Q1, TPS76833-Q1, TPS76850-Q1, TPS76801-Q1
 FAST-TRANSIENT-RESPONSE 1-A LOW-DROPOUT VOLTAGE REGULATORS**

SGLS155A – FEBRUARY 2003 – REVISED SEPTEMBER 2008

TYPICAL CHARACTERISTICS

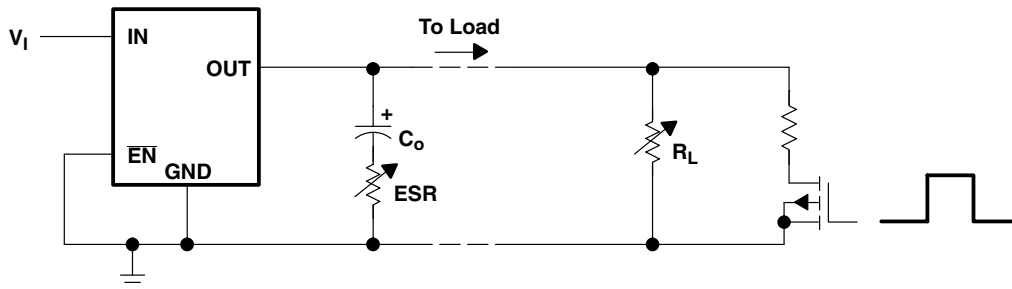
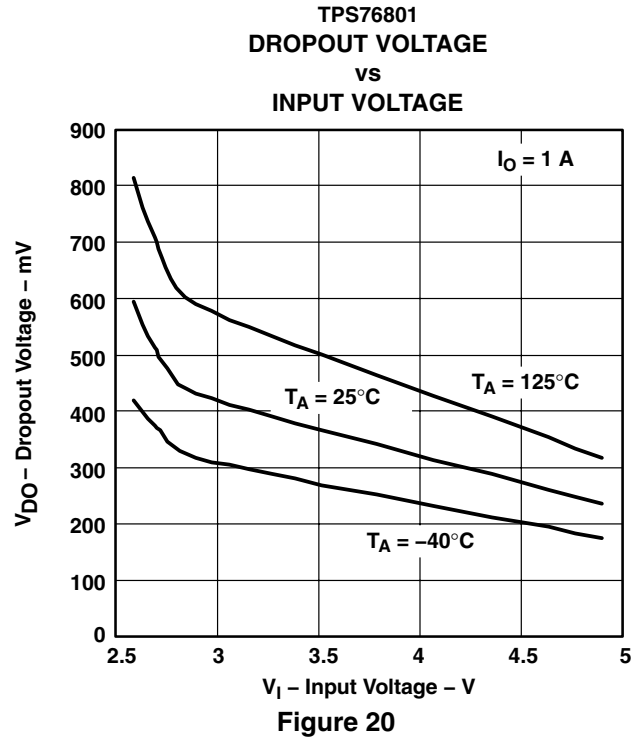
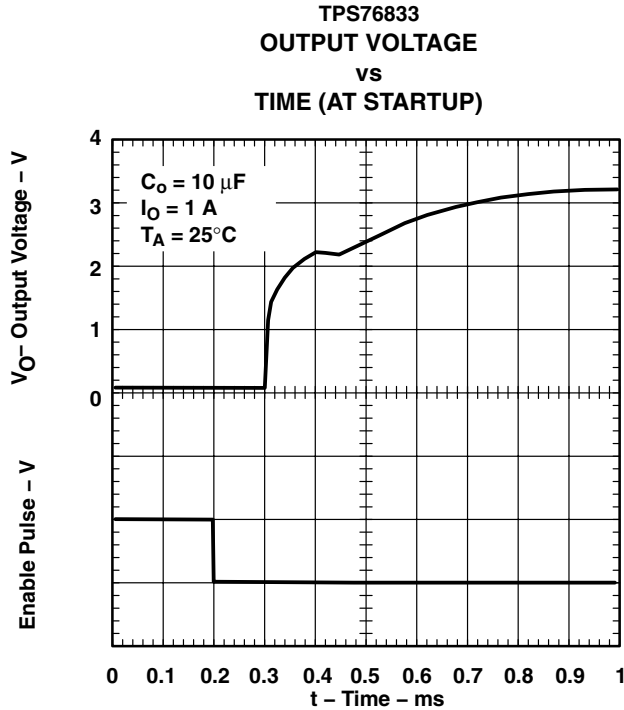

Figure 21. Test Circuit for Typical Regions of Stability (Figures 22 through 25) (Fixed Output Options)

**TPS76815-Q1, TPS76818-Q1, TPS76825-Q1, TPS76827-Q1
 TPS76828-Q1, TPS76830-Q1, TPS76833-Q1, TPS76850-Q1, TPS76801-Q1
 FAST-TRANSIENT-RESPONSE 1-A LOW-DROPOUT VOLTAGE REGULATORS**

SGLS155A – FEBRUARY 2003 – REVISED SEPTEMBER 2008

TYPICAL CHARACTERISTICS

**TYPICAL REGION OF STABILITY
 EQUIVALENT SERIES RESISTANCE†
 vs
 OUTPUT CURRENT**

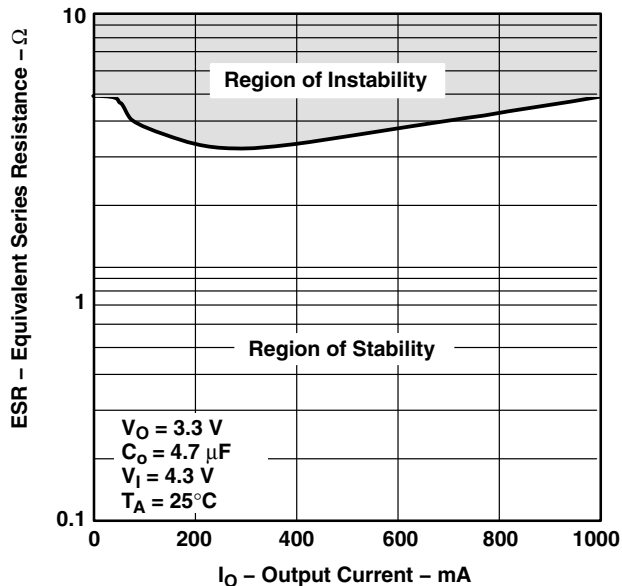

Figure 22

**TYPICAL REGION OF STABILITY
 EQUIVALENT SERIES RESISTANCE†
 vs
 OUTPUT CURRENT**

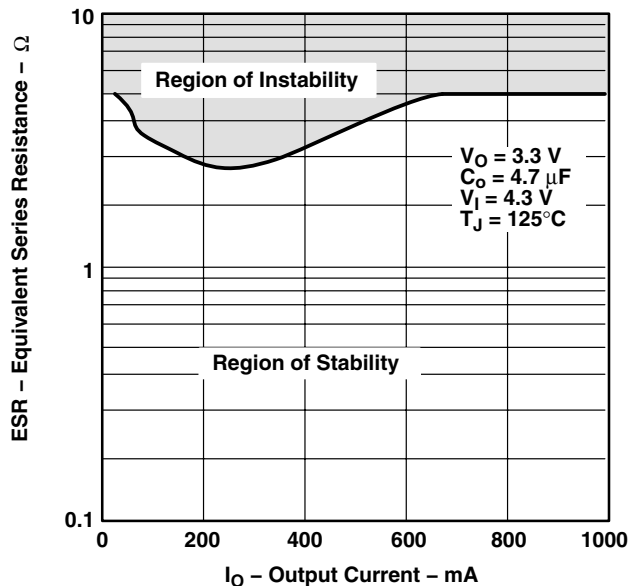

Figure 23

**TYPICAL REGION OF STABILITY
 EQUIVALENT SERIES RESISTANCE†
 vs
 OUTPUT CURRENT**

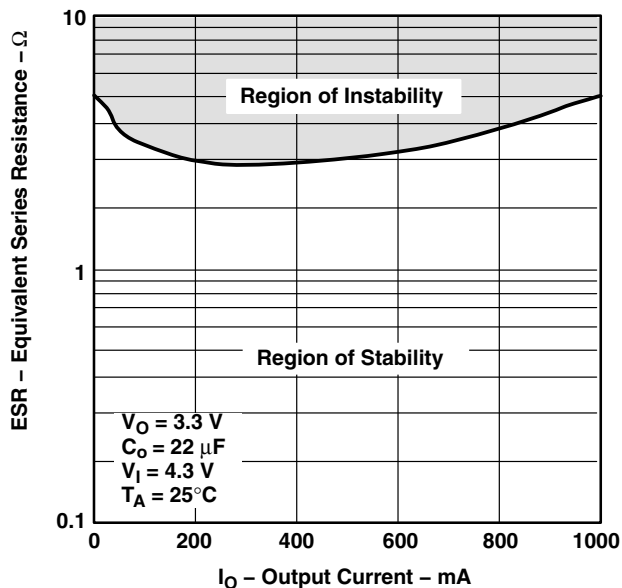

Figure 24

**TYPICAL REGION OF STABILITY
 EQUIVALENT SERIES RESISTANCE†
 vs
 OUTPUT CURRENT**

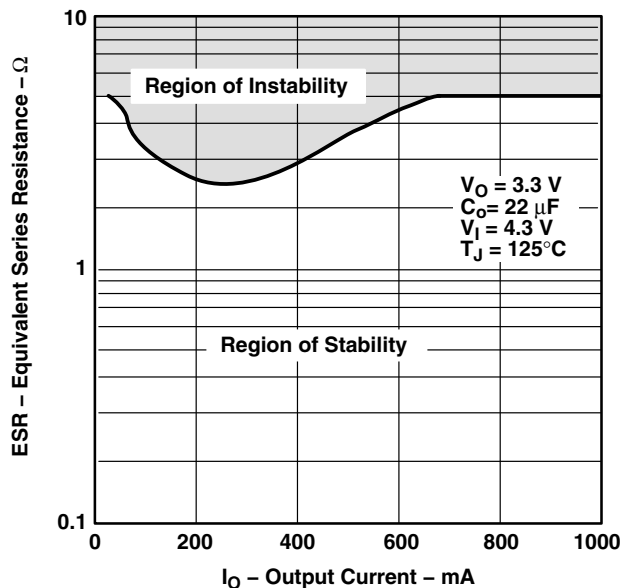

Figure 25

† Equivalent series resistance (ESR) refers to the total series resistance, including the ESR of the capacitor, any series resistance added externally, and PWB trace resistance to C_O.



**TPS76815-Q1, TPS76818-Q1, TPS76825-Q1, TPS76827-Q1
TPS76828-Q1, TPS76830-Q1, TPS76833-Q1, TPS76850-Q1, TPS76801-Q1
FAST-TRANSIENT-RESPONSE 1-A LOW-DROPOUT VOLTAGE REGULATORS**

SGLS155A – FEBRUARY 2003 – REVISED SEPTEMBER 2008

APPLICATION INFORMATION

The TPS768xx family includes eight fixed-output voltage regulators (1.5 V, 1.8 V, 2.5 V, 2.7 V, 2.8 V, 3.0 V, 3.3 V, and 5.0 V), and offers an adjustable device, the TPS76801 (adjustable from 1.2 V to 5.5 V).

device operation

The TPS768xx features very low quiescent current, which remains virtually constant even with varying loads. Conventional LDO regulators use a pnp pass element, the base current of which is directly proportional to the load current through the regulator ($I_B = I_O/\beta$). The TPS768xx uses a PMOS transistor to pass current; because the gate of the PMOS is voltage driven, operating current is low and invariable over the full load range.

Another pitfall associated with the pnp-pass element is its tendency to saturate when the device goes into dropout. The resulting drop in β forces an increase in I_B to maintain the load. During power up, this translates to large start-up currents. Systems with limited supply current may fail to start up. In battery-powered systems, it means rapid battery discharge when the voltage decays below the minimum required for regulation. The TPS768xx quiescent current remains low even when the regulator drops out, eliminating both problems.

The TPS768xx family also features a shutdown mode that places the output in the high-impedance state (essentially equal to the feedback-divider resistance) and reduces quiescent current to 2 μ A. If the shutdown feature is not used, \overline{EN} should be tied to ground.

minimum load requirements

The TPS768xx family is stable even at zero load; no minimum load is required for operation.

FB - pin connection (adjustable version only)

The FB pin is an input pin to sense the output voltage and close the loop for the adjustable option. The output voltage is sensed through a resistor divider network to close the loop as shown in Figure 27. Normally, this connection should be as short as possible; however, the connection can be made near a critical circuit to improve performance at that point. Internally, FB connects to a high-impedance wide-bandwidth amplifier and noise pickup feeds through to the regulator output. Routing the FB connection to minimize/avoid noise pickup is essential.

external capacitor requirements

An input capacitor is not usually required; however, a ceramic bypass capacitor (0.047 μ F or larger) improves load transient response and noise rejection if the TPS768xx is located more than a few inches from the power supply. A higher-capacitance electrolytic capacitor may be necessary if large (hundreds of milliamps) load transients with fast rise times are anticipated.

Like all low dropout regulators, the TPS768xx requires an output capacitor connected between OUT and GND to stabilize the internal control loop. The minimum recommended capacitance value is 10 μ F and the ESR (equivalent series resistance) must be between 50 m Ω and 1.5 Ω . Capacitor values 10 μ F or larger are acceptable, provided the ESR is less than 1.5 Ω . Solid tantalum electrolytic, aluminum electrolytic, and multilayer ceramic capacitors are all suitable, provided they meet the requirements described above. Most of the commercially available 10 μ F surface-mount ceramic capacitors, including devices from Sprague and Kemet, meet the ESR requirements stated above.



**TPS76815-Q1, TPS76818-Q1, TPS76825-Q1, TPS76827-Q1
 TPS76828-Q1, TPS76830-Q1, TPS76833-Q1, TPS76850-Q1, TPS76801-Q1
 FAST-TRANSIENT-RESPONSE 1-A LOW-DROPOUT VOLTAGE REGULATORS**

SGLS155A – FEBRUARY 2003 – REVISED SEPTEMBER 2008

APPLICATION INFORMATION

external capacitor requirements (continued)

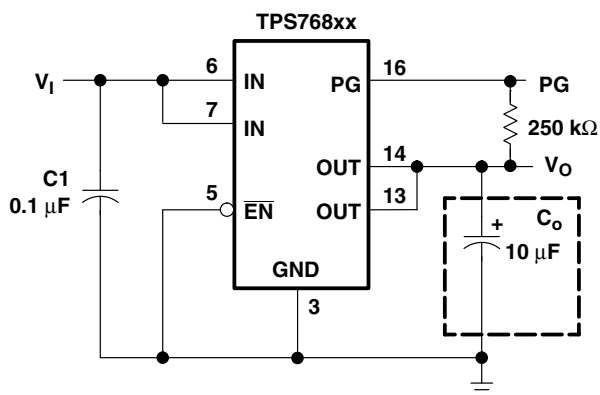

Figure 26. Typical Application Circuit (Fixed Versions)

programming the TPS76801 adjustable LDO regulator

The output voltage of the TPS76801 adjustable regulator is programmed using an external resistor divider as shown in Figure 27. The output voltage is calculated using:

$$V_O = V_{ref} \times \left(1 + \frac{R1}{R2}\right) \tag{1}$$

Where:

$$V_{ref} = 1.1834 \text{ V typ (the internal reference voltage)}$$

Resistors R1 and R2 should be chosen for approximately 50-μA divider current. Lower value resistors can be used but offer no inherent advantage and waste more power. Higher values should be avoided as leakage currents at FB increase the output voltage error. The recommended design procedure is to choose R2 = 30.1 kΩ to set the divider current at 50 μA and then calculate R1 using:

$$R1 = \left(\frac{V_O}{V_{ref}} - 1\right) \times R2 \tag{2}$$

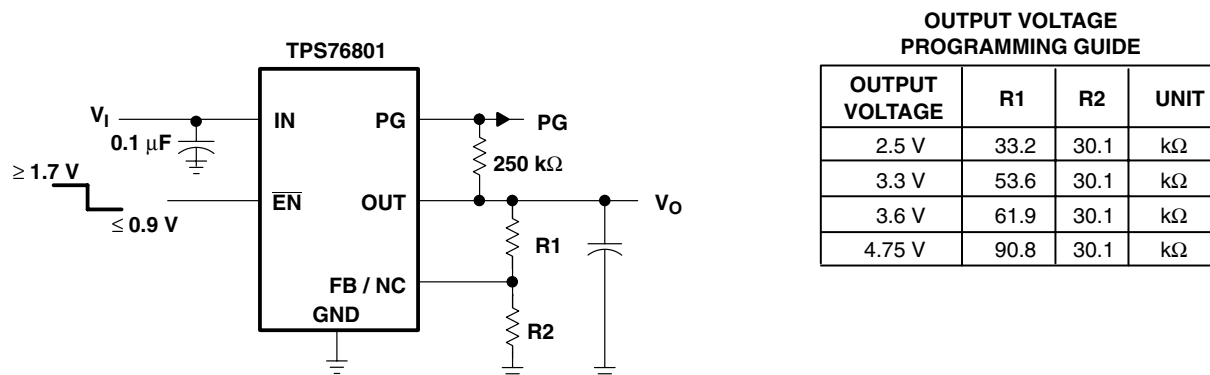

Figure 27. TPS76801 Adjustable LDO Regulator Programming



APPLICATION INFORMATION

power-good indicator

The TPS768xx features a power-good (PG) output that can be used to monitor the status of the regulator. The internal comparator monitors the output voltage: when the output drops to between 92% and 98% of its nominal regulated value, the PG output transistor turns on, taking the signal low. The open-drain output requires a pullup resistor. If not used, it can be left floating. PG can be used to drive power-on reset circuitry or used as a low-battery indicator. PG does not assert itself when the regulated output voltage falls out of the specified 2% tolerance, but instead reports an output voltage low, relative to its nominal regulated value.

regulator protection

The TPS768xx PMOS-pass transistor has a built-in back diode that conducts reverse currents when the input voltage drops below the output voltage (e.g., during power down). Current is conducted from the output to the input and is not internally limited. When extended reverse voltage is anticipated, external limiting may be appropriate.

The TPS768xx also features internal current limiting and thermal protection. During normal operation, the TPS768xx limits output current to approximately 1.7 A. When current limiting engages, the output voltage scales back linearly until the overcurrent condition ends. While current limiting is designed to prevent gross device failure, care should be taken not to exceed the power dissipation ratings of the package. If the temperature of the device exceeds 150°C(typ), thermal-protection circuitry shuts it down. Once the device has cooled below 130°C(typ), regulator operation resumes.

power dissipation and junction temperature

Specified regulator operation is assured to a junction temperature of 125°C; the maximum junction temperature should be restricted to 125°C under normal operating conditions. This restriction limits the power dissipation the regulator can handle in any given application. To ensure the junction temperature is within acceptable limits, calculate the maximum allowable dissipation, $P_{D(max)}$, and the actual dissipation, P_D , which must be less than or equal to $P_{D(max)}$.

The maximum-power-dissipation limit is determined using the following equation:

$$P_{D(max)} = \frac{T_{Jmax} - T_A}{R_{\theta JA}}$$

Where:

T_{Jmax} is the maximum allowable junction temperature.

$R_{\theta JA}$ is the thermal resistance junction-to-ambient for the package, i.e., 172°C/W for the 8-terminal SOIC and 32.6°C/W for the 20-terminal PWP with no airflow.

T_A is the ambient temperature.

The regulator dissipation is calculated using:

$$P_D = (V_I - V_O) \times I_O$$

Power dissipation resulting from quiescent current is negligible. Excessive power dissipation will trigger the thermal protection circuit.

PACKAGING INFORMATION

Orderable Device	Status (1)	Package Type	Package Drawing	Pins	Package Qty	Eco Plan (2)	Lead/Ball Finish (6)	MSL Peak Temp (3)	Op Temp (°C)	Device Marking (4/5)	Samples
TPS76801QPWPRG4Q1	ACTIVE	HTSSOP	PWP	20	2000	Green (RoHS & no Sb/Br)	CU NIPDAU	Level-3-260C-168 HR	-40 to 125	76801Q1	Samples
TPS76801QPWPRQ1	ACTIVE	HTSSOP	PWP	20	2000	Green (RoHS & no Sb/Br)	CU NIPDAU	Level-3-260C-168 HR	-40 to 125	76801Q1	Samples
TPS76818QPWPRQ1	ACTIVE	HTSSOP	PWP	20	2000	Green (RoHS & no Sb/Br)	CU NIPDAU	Level-3-260C-168 HR	-40 to 125	76818Q1	Samples
TPS76825QPWPRQ1	ACTIVE	HTSSOP	PWP	20	2000	Green (RoHS & no Sb/Br)	CU NIPDAU	Level-3-260C-168 HR	-40 to 125	76825Q1	Samples
TPS76833QPWPRQ1	ACTIVE	HTSSOP	PWP	20	2000	Green (RoHS & no Sb/Br)	CU NIPDAU	Level-3-260C-168 HR	-40 to 125	76833Q1	Samples
TPS76850QPWPRQ1	ACTIVE	HTSSOP	PWP	20	2000	Green (RoHS & no Sb/Br)	CU NIPDAU	Level-3-260C-168 HR	-40 to 125	76850Q1	Samples

(1) The marketing status values are defined as follows:

ACTIVE: Product device recommended for new designs.

LIFEBUY: TI has announced that the device will be discontinued, and a lifetime-buy period is in effect.

NRND: Not recommended for new designs. Device is in production to support existing customers, but TI does not recommend using this part in a new design.

PREVIEW: Device has been announced but is not in production. Samples may or may not be available.

OBSELETE: TI has discontinued the production of the device.

(2) Eco Plan - The planned eco-friendly classification: Pb-Free (RoHS), Pb-Free (RoHS Exempt), or Green (RoHS & no Sb/Br) - please check <http://www.ti.com/productcontent> for the latest availability information and additional product content details.

TBD: The Pb-Free/Green conversion plan has not been defined.

Pb-Free (RoHS): TI's terms "Lead-Free" or "Pb-Free" mean semiconductor products that are compatible with the current RoHS requirements for all 6 substances, including the requirement that lead not exceed 0.1% by weight in homogeneous materials. Where designed to be soldered at high temperatures, TI Pb-Free products are suitable for use in specified lead-free processes.

Pb-Free (RoHS Exempt): This component has a RoHS exemption for either 1) lead-based flip-chip solder bumps used between the die and package, or 2) lead-based die adhesive used between the die and leadframe. The component is otherwise considered Pb-Free (RoHS compatible) as defined above.

Green (RoHS & no Sb/Br): TI defines "Green" to mean Pb-Free (RoHS compatible), and free of Bromine (Br) and Antimony (Sb) based flame retardants (Br or Sb do not exceed 0.1% by weight in homogeneous material)

(3) MSL, Peak Temp. - The Moisture Sensitivity Level rating according to the JEDEC industry standard classifications, and peak solder temperature.

(4) There may be additional marking, which relates to the logo, the lot trace code information, or the environmental category on the device.

(5) Multiple Device Markings will be inside parentheses. Only one Device Marking contained in parentheses and separated by a "~" will appear on a device. If a line is indented then it is a continuation of the previous line and the two combined represent the entire Device Marking for that device.

⁽⁶⁾ Lead/Ball Finish - Orderable Devices may have multiple material finish options. Finish options are separated by a vertical ruled line. Lead/Ball Finish values may wrap to two lines if the finish value exceeds the maximum column width.

Important Information and Disclaimer: The information provided on this page represents TI's knowledge and belief as of the date that it is provided. TI bases its knowledge and belief on information provided by third parties, and makes no representation or warranty as to the accuracy of such information. Efforts are underway to better integrate information from third parties. TI has taken and continues to take reasonable steps to provide representative and accurate information but may not have conducted destructive testing or chemical analysis on incoming materials and chemicals. TI and TI suppliers consider certain information to be proprietary, and thus CAS numbers and other limited information may not be available for release.

In no event shall TI's liability arising out of such information exceed the total purchase price of the TI part(s) at issue in this document sold by TI to Customer on an annual basis.

OTHER QUALIFIED VERSIONS OF TPS76801-Q1, TPS76818-Q1, TPS76825-Q1, TPS76827-Q1, TPS76828-Q1, TPS76830-Q1, TPS76833-Q1, TPS76850-Q1 :

- Catalog: [TPS76801](#), [TPS76818](#), [TPS76825](#), [TPS76827](#), [TPS76828](#), [TPS76830](#), [TPS76833](#), [TPS76850](#)
- Enhanced Product: [TPS76801-EP](#), [TPS76818-EP](#), [TPS76825-EP](#), [TPS76833-EP](#), [TPS76850-EP](#)

NOTE: Qualified Version Definitions:

- Catalog - TI's standard catalog product
- Enhanced Product - Supports Defense, Aerospace and Medical Applications

MECHANICAL DATA

PWP (R-PDSO-G20)

PowerPAD™ PLASTIC SMALL OUTLINE

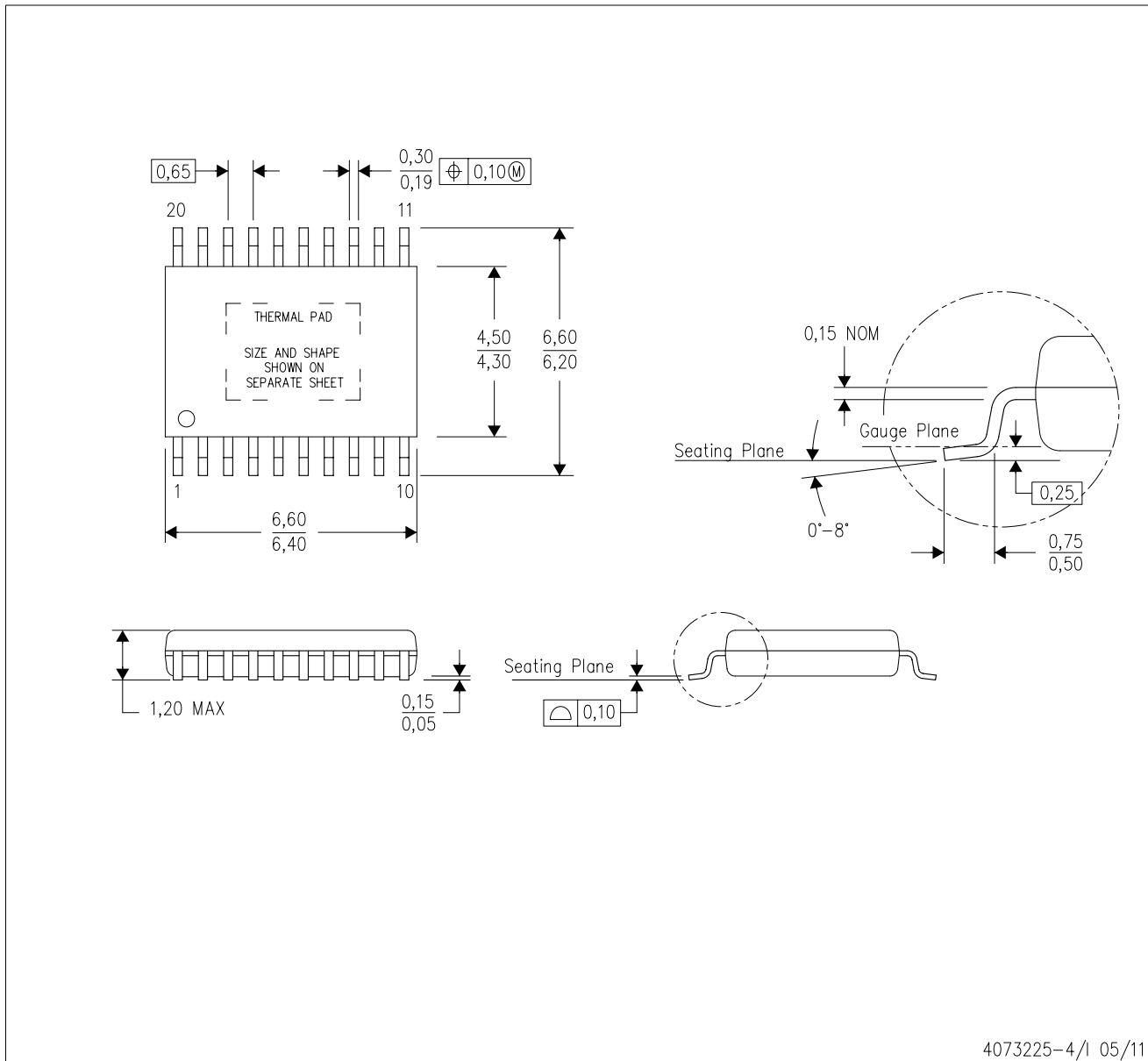

4073225-4/1 05/11

- NOTES:
- All linear dimensions are in millimeters.
 - This drawing is subject to change without notice.
 - Body dimensions do not include mold flash or protrusions. Mold flash and protrusion shall not exceed 0.15 per side.
 - This package is designed to be soldered to a thermal pad on the board. Refer to Technical Brief, PowerPad Thermally Enhanced Package, Texas Instruments Literature No. SLMA002 for information regarding recommended board layout. This document is available at www.ti.com <<http://www.ti.com>>.
 - See the additional figure in the Product Data Sheet for details regarding the exposed thermal pad features and dimensions.
 - Falls within JEDEC MO-153

PowerPAD is a trademark of Texas Instruments.

THERMAL PAD MECHANICAL DATA

PWP (R-PDSO-G20) PowerPAD™ SMALL PLASTIC OUTLINE

THERMAL INFORMATION

This PowerPAD™ package incorporates an exposed thermal pad that is designed to be attached to a printed circuit board (PCB). The thermal pad must be soldered directly to the PCB. After soldering, the PCB can be used as a heatsink. In addition, through the use of thermal vias, the thermal pad can be attached directly to the appropriate copper plane shown in the electrical schematic for the device, or alternatively, can be attached to a special heatsink structure designed into the PCB. This design optimizes the heat transfer from the integrated circuit (IC).

For additional information on the PowerPAD package and how to take advantage of its heat dissipating abilities, refer to Technical Brief, PowerPAD Thermally Enhanced Package, Texas Instruments Literature No. SLMA002 and Application Brief, PowerPAD Made Easy, Texas Instruments Literature No. SLMA004. Both documents are available at www.ti.com.

The exposed thermal pad dimensions for this package are shown in the following illustration.

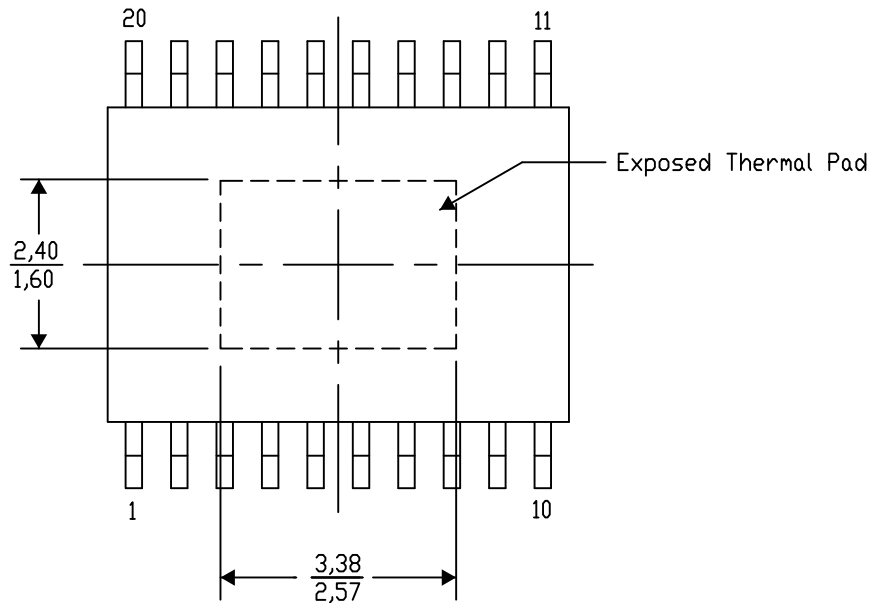

Top View

Exposed Thermal Pad Dimensions

4206332-13/AO 01/16

NOTE: A. All linear dimensions are in millimeters

PowerPAD is a trademark of Texas Instruments

PWP (R-PDSO-G20)

PowerPAD™ PLASTIC SMALL OUTLINE

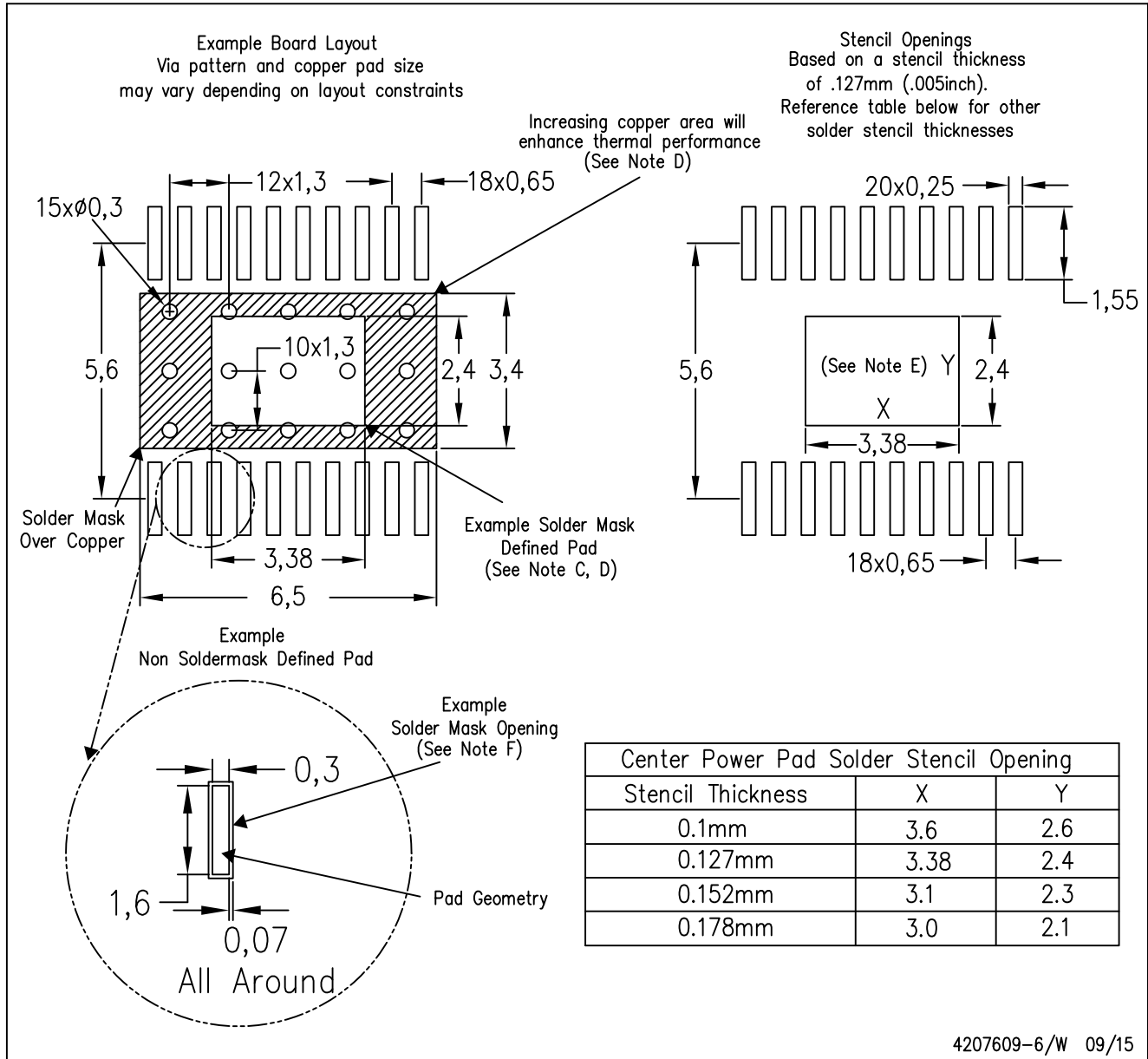

- NOTES:
- All linear dimensions are in millimeters.
 - This drawing is subject to change without notice.
 - Customers should place a note on the circuit board fabrication drawing not to alter the center solder mask defined pad.
 - This package is designed to be soldered to a thermal pad on the board. Refer to Technical Brief, PowerPad Thermally Enhanced Package, Texas Instruments Literature No. SLMA002, SLMA004, and also the Product Data Sheets for specific thermal information, via requirements, and recommended board layout. These documents are available at www.ti.com <<http://www.ti.com>>. Publication IPC-7351 is recommended for alternate designs.
 - Laser cutting apertures with trapezoidal walls and also rounding corners will offer better paste release. Customers should contact their board assembly site for stencil design recommendations. Example stencil design based on a 50% volumetric metal load solder paste. Refer to IPC-7525 for other stencil recommendations.
 - Customers should contact their board fabrication site for solder mask tolerances between and around signal pads.

THERMAL PAD MECHANICAL DATA

PWP (R-PDSO-G20) PowerPAD™ SMALL PLASTIC OUTLINE

THERMAL INFORMATION

This PowerPAD™ package incorporates an exposed thermal pad that is designed to be attached to a printed circuit board (PCB). The thermal pad must be soldered directly to the PCB. After soldering, the PCB can be used as a heatsink. In addition, through the use of thermal vias, the thermal pad can be attached directly to the appropriate copper plane shown in the electrical schematic for the device, or alternatively, can be attached to a special heatsink structure designed into the PCB. This design optimizes the heat transfer from the integrated circuit (IC).

For additional information on the PowerPAD package and how to take advantage of its heat dissipating abilities, refer to Technical Brief, PowerPAD Thermally Enhanced Package, Texas Instruments Literature No. SLMA002 and Application Brief, PowerPAD Made Easy, Texas Instruments Literature No. SLMA004. Both documents are available at www.ti.com.

The exposed thermal pad dimensions for this package are shown in the following illustration.

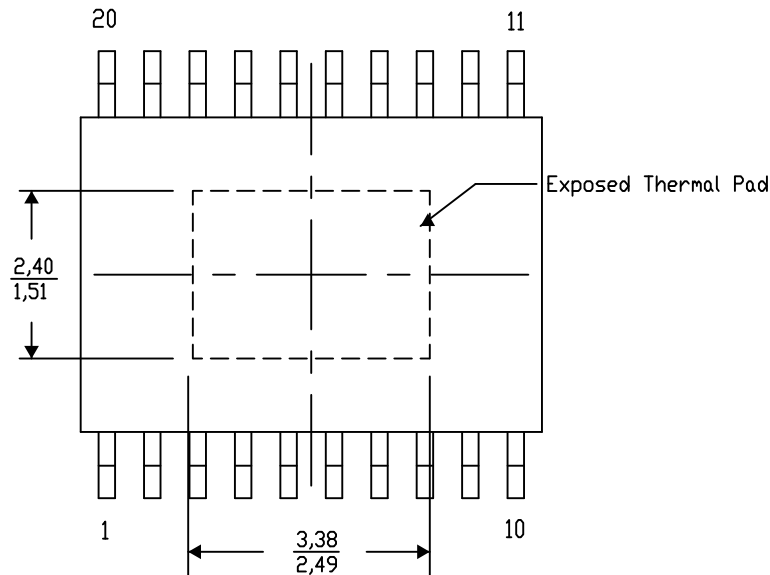

Exposed Thermal Pad Dimensions

4206332-20/AO 01/16

NOTE: A. All linear dimensions are in millimeters

PowerPAD is a trademark of Texas Instruments

THERMAL PAD MECHANICAL DATA

PWP (R-PDSO-G20) PowerPAD™ SMALL PLASTIC OUTLINE

THERMAL INFORMATION

This PowerPAD™ package incorporates an exposed thermal pad that is designed to be attached to a printed circuit board (PCB). The thermal pad must be soldered directly to the PCB. After soldering, the PCB can be used as a heatsink. In addition, through the use of thermal vias, the thermal pad can be attached directly to the appropriate copper plane shown in the electrical schematic for the device, or alternatively, can be attached to a special heatsink structure designed into the PCB. This design optimizes the heat transfer from the integrated circuit (IC).

For additional information on the PowerPAD package and how to take advantage of its heat dissipating abilities, refer to Technical Brief, PowerPAD Thermally Enhanced Package, Texas Instruments Literature No. SLMA002 and Application Brief, PowerPAD Made Easy, Texas Instruments Literature No. SLMA004. Both documents are available at www.ti.com.

The exposed thermal pad dimensions for this package are shown in the following illustration.

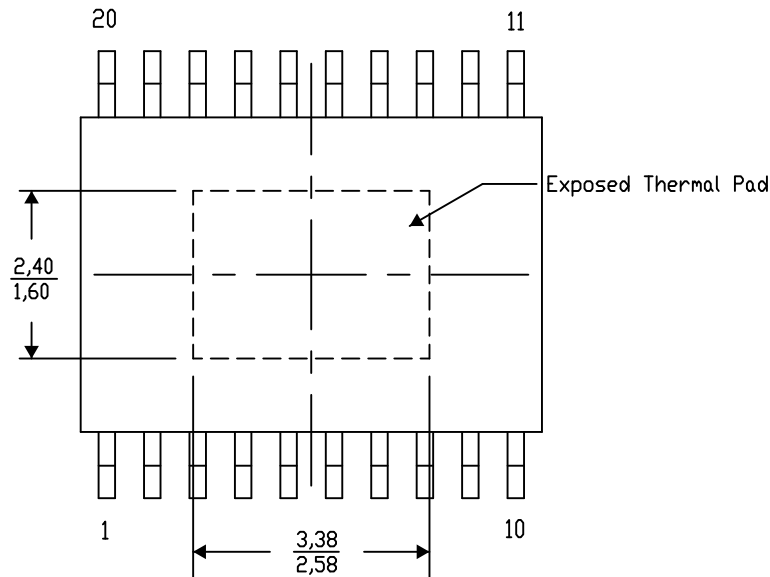

Exposed Thermal Pad Dimensions

4206332-21/AO 01/16

NOTE: A. All linear dimensions are in millimeters

PowerPAD is a trademark of Texas Instruments

THERMAL PAD MECHANICAL DATA

PWP (R-PDSO-G20) PowerPAD™ SMALL PLASTIC OUTLINE

THERMAL INFORMATION

This PowerPAD™ package incorporates an exposed thermal pad that is designed to be attached to a printed circuit board (PCB). The thermal pad must be soldered directly to the PCB. After soldering, the PCB can be used as a heatsink. In addition, through the use of thermal vias, the thermal pad can be attached directly to the appropriate copper plane shown in the electrical schematic for the device, or alternatively, can be attached to a special heatsink structure designed into the PCB. This design optimizes the heat transfer from the integrated circuit (IC).

For additional information on the PowerPAD package and how to take advantage of its heat dissipating abilities, refer to Technical Brief, PowerPAD Thermally Enhanced Package, Texas Instruments Literature No. SLMA002 and Application Brief, PowerPAD Made Easy, Texas Instruments Literature No. SLMA004. Both documents are available at www.ti.com.

The exposed thermal pad dimensions for this package are shown in the following illustration.

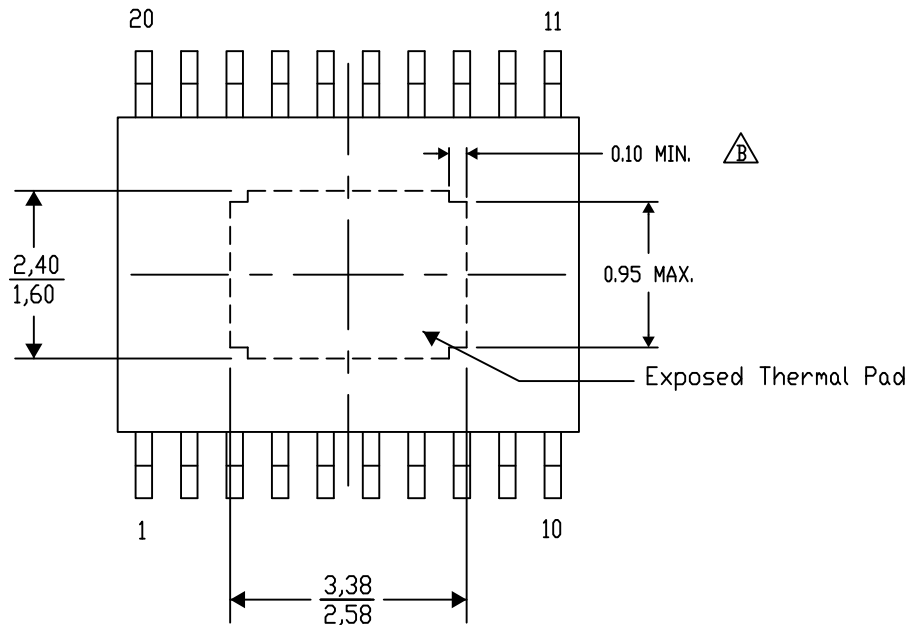

Exposed Thermal Pad Dimensions

4206332-23/A0 01/16

NOTE: A. All linear dimensions are in millimeters

 Exposed tie strap features may not be present.

PowerPAD is a trademark of Texas Instruments

IMPORTANT NOTICE

Texas Instruments Incorporated and its subsidiaries (TI) reserve the right to make corrections, enhancements, improvements and other changes to its semiconductor products and services per JESD46, latest issue, and to discontinue any product or service per JESD48, latest issue. Buyers should obtain the latest relevant information before placing orders and should verify that such information is current and complete. All semiconductor products (also referred to herein as "components") are sold subject to TI's terms and conditions of sale supplied at the time of order acknowledgment.

TI warrants performance of its components to the specifications applicable at the time of sale, in accordance with the warranty in TI's terms and conditions of sale of semiconductor products. Testing and other quality control techniques are used to the extent TI deems necessary to support this warranty. Except where mandated by applicable law, testing of all parameters of each component is not necessarily performed.

TI assumes no liability for applications assistance or the design of Buyers' products. Buyers are responsible for their products and applications using TI components. To minimize the risks associated with Buyers' products and applications, Buyers should provide adequate design and operating safeguards.

TI does not warrant or represent that any license, either express or implied, is granted under any patent right, copyright, mask work right, or other intellectual property right relating to any combination, machine, or process in which TI components or services are used. Information published by TI regarding third-party products or services does not constitute a license to use such products or services or a warranty or endorsement thereof. Use of such information may require a license from a third party under the patents or other intellectual property of the third party, or a license from TI under the patents or other intellectual property of TI.

Reproduction of significant portions of TI information in TI data books or data sheets is permissible only if reproduction is without alteration and is accompanied by all associated warranties, conditions, limitations, and notices. TI is not responsible or liable for such altered documentation. Information of third parties may be subject to additional restrictions.

Resale of TI components or services with statements different from or beyond the parameters stated by TI for that component or service voids all express and any implied warranties for the associated TI component or service and is an unfair and deceptive business practice. TI is not responsible or liable for any such statements.

Buyer acknowledges and agrees that it is solely responsible for compliance with all legal, regulatory and safety-related requirements concerning its products, and any use of TI components in its applications, notwithstanding any applications-related information or support that may be provided by TI. Buyer represents and agrees that it has all the necessary expertise to create and implement safeguards which anticipate dangerous consequences of failures, monitor failures and their consequences, lessen the likelihood of failures that might cause harm and take appropriate remedial actions. Buyer will fully indemnify TI and its representatives against any damages arising out of the use of any TI components in safety-critical applications.

In some cases, TI components may be promoted specifically to facilitate safety-related applications. With such components, TI's goal is to help enable customers to design and create their own end-product solutions that meet applicable functional safety standards and requirements. Nonetheless, such components are subject to these terms.

No TI components are authorized for use in FDA Class III (or similar life-critical medical equipment) unless authorized officers of the parties have executed a special agreement specifically governing such use.

Only those TI components which TI has specifically designated as military grade or "enhanced plastic" are designed and intended for use in military/aerospace applications or environments. Buyer acknowledges and agrees that any military or aerospace use of TI components which have **not** been so designated is solely at the Buyer's risk, and that Buyer is solely responsible for compliance with all legal and regulatory requirements in connection with such use.

TI has specifically designated certain components as meeting ISO/TS16949 requirements, mainly for automotive use. In any case of use of non-designated products, TI will not be responsible for any failure to meet ISO/TS16949.

Products

Audio	www.ti.com/audio
Amplifiers	amplifier.ti.com
Data Converters	dataconverter.ti.com
DLP® Products	www.dlp.com
DSP	dsp.ti.com
Clocks and Timers	www.ti.com/clocks
Interface	interface.ti.com
Logic	logic.ti.com
Power Mgmt	power.ti.com
Microcontrollers	microcontroller.ti.com
RFID	www.ti-rfid.com
OMAP Applications Processors	www.ti.com/omap
Wireless Connectivity	www.ti.com/wirelessconnectivity

Applications

Automotive and Transportation	www.ti.com/automotive
Communications and Telecom	www.ti.com/communications
Computers and Peripherals	www.ti.com/computers
Consumer Electronics	www.ti.com/consumer-apps
Energy and Lighting	www.ti.com/energy
Industrial	www.ti.com/industrial
Medical	www.ti.com/medical
Security	www.ti.com/security
Space, Avionics and Defense	www.ti.com/space-avionics-defense
Video and Imaging	www.ti.com/video

TI E2E Community

e2e.ti.com