

# Wireless Bipolar Power Transistor, 35W

## 850 - 960 MHz

PH0810-35

V2.00

### Features

- Designed for Linear Amplifier Applications
- Class AB: -30dBc Typ 3rd IMD at 15 Watts PEP
- Class A: +53dBm Typ 3rd Order Intercept Point
- Common Emitter Configuration
- Internal Input Impedance Matching
- Diffused Emitter Ballasting

### Absolute Maximum Ratings at 25°C

Parameter	Symbol	Rating	Units
Collector-Base Voltage	$V_{CBO}$	60	V
Collector-Emitter Voltage	$V_{CES}$	60	V
Emitter-Base Voltage	$V_{EBO}$	3.0	V
Collector Current	$I_C$	1.0	A
Total Power Dissipation	$P_{TOT}$	116	W
Junction Temperature	$T_J$	200	°C
Storage Temperature	$T_{STG}$	-55 to +150	°C
Thermal Resistance	$\theta_{JC}$	1.5	°C/W

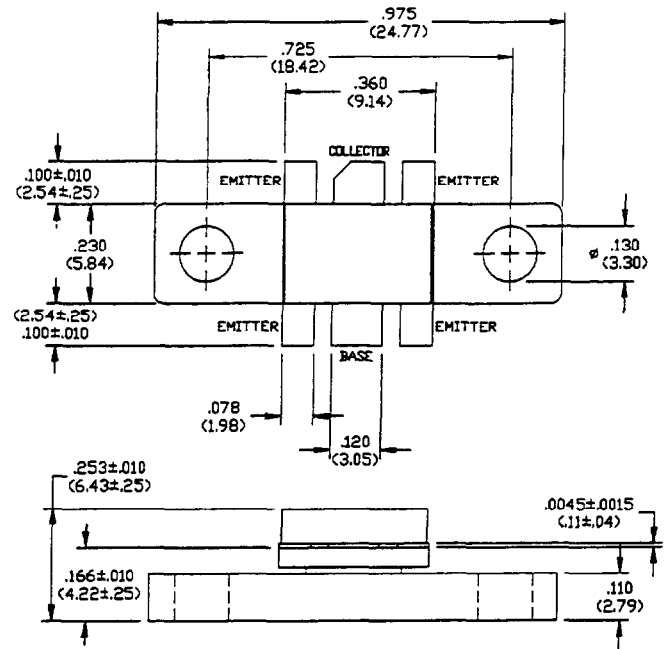

UNLESS OTHERWISE NOTED, TOLERANCES ARE INCHES ±.005\*  
(MILLIMETERS ±.13MM)

### Electrical Characteristics at 25°C

Parameter	Symbol	Min	Max	Units	Test Conditions
Collector-Emitter Breakdown Voltage	$BV_{CES}$	60	-	V	$I_C=20$ mA
Collector-Emitter Leakage Current	$I_{CES}$	-	2.0	mA	$V_{CE}=24.0$ V
Collector-Emitter Breakdown Voltage	$BV_{CEO}$	24	-	V	$I_C=40$ mA
Emitter-Base Breakdown Voltage	$BV_{EBO}$	3.0	-	V	$I_E=20$ mA
DC Forward Current Gain	$h_{FE}$	15	120	-	$V_{CE}=5.0$ V, $I_C=1.0$ A
Power Gain	$G_P$	10	-	dB	$V_{CC}=24$ V, $I_{CO}=200$ mA, $P_{OUT}=35$ W, $F=900$ MHz
Collector Efficiency	$\eta_C$	55	-	%	$V_{CC}=24$ V, $I_{CO}=200$ mA, $P_{OUT}=35$ W, $F=900$ MHz
Input Return Loss	RL	10	-	dB	$V_{CC}=24$ V, $I_{CO}=200$ mA, $P_{OUT}=35$ W, $F=900$ MHz
Load Mismatch Tolerance	VSWR-T	-	3.0:1	-	$V_{CC}=24$ V, $I_{CO}=200$ mA, $P_{OUT}=35$ W PEP, $F=900$ MHz, $\Delta F=100$ kHz
3rd Order IMD	$IMD_3$	-	-30	dBc	$V_{CC}=24$ V, $I_{CO}=200$ mA, $P_{OUT}=35$ W PEP, $F=900$ MHz, $\Delta F=100$ kHz

### Typical Optimum Device Impedances

F(MHz)	$Z_{IN}(\Omega)$	$Z_{LOAD}(\Omega)$
800	$1.0 + j3.7$	$2.1 + j0.9$
850	$1.3 + j4.0$	$1.6 + j0.7$
900	$1.9 + j4.3$	$1.6 + j0.4$
960	$3.0 + j2.7$	$1.7 + j0.1$

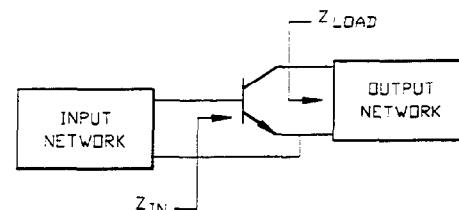

Typical Broadband Performance Curves

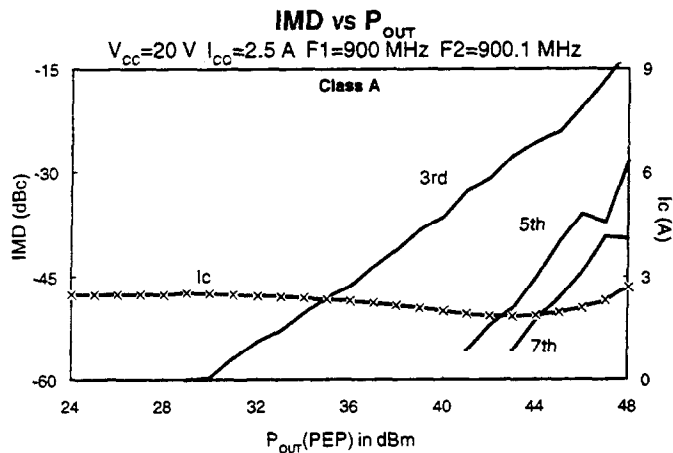
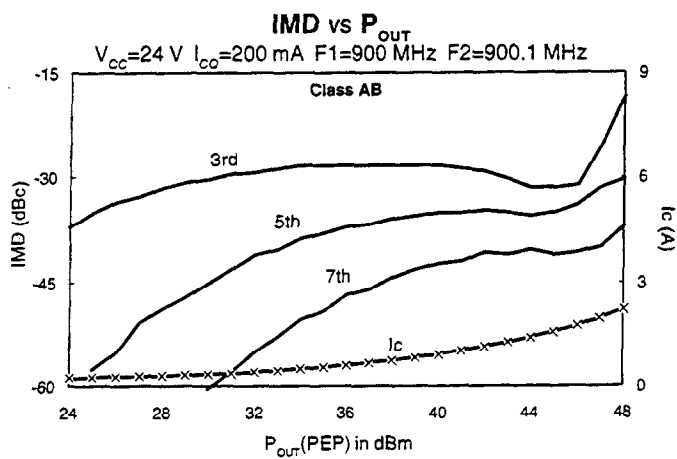
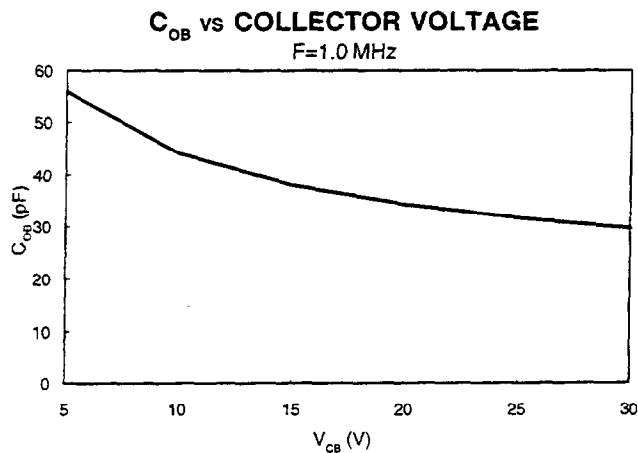
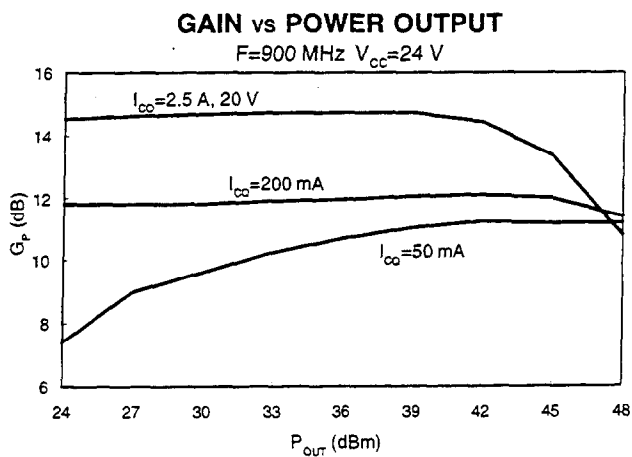
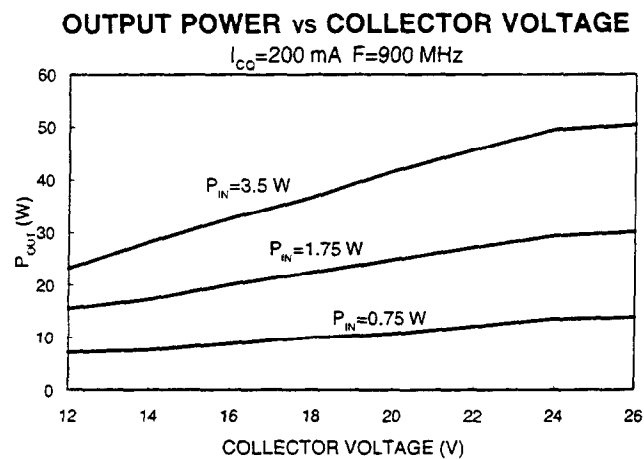
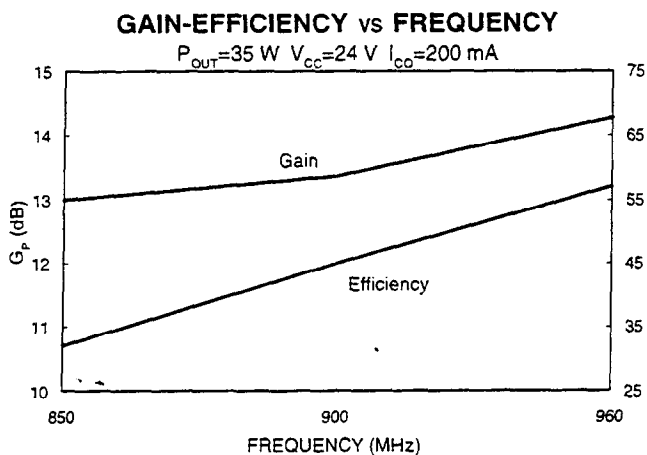

RF Test Fixture

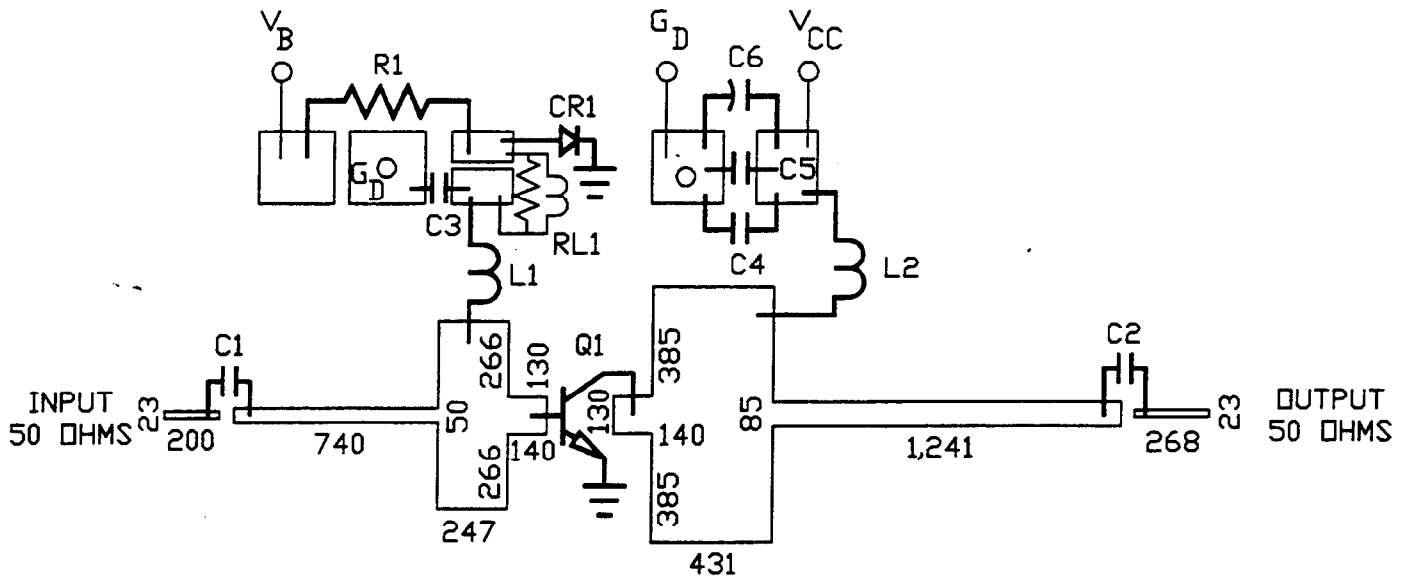

ARTWORK DIMENSIONS IN MILS

PARTS LIST

C1	C2	C3	C4	100 pF	ATC	SIZE B
C5				5000 pF		
C6				50 uF	50 VOLTS	
CR1				1N4245	DIODE	
L1	L2			10T/ND.	20 AWG	ON 1/8" DIAMETER
Q1				PH0810-35		
R1				5 OHMS	1/4 WATT	
RL1				10T/ND.	22 AWG	ON 3.1 OHM 1/4 WATT
BOARD TYPE				ROGERS	6010.5	.025" THICK, $E_R = 10.5$