



# AKD5365

## AK5365 Evaluation Board Rev.A

### GENERAL DESCRIPTION

AKD5365 is an evaluation board for the digital audio 24bit 96kHz A/D converter, AK5365. The AKD5365 includes the input circuit and also has a digital interface transmitter. Further, the AKD5365 can achieve the interface with digital audio systems via opt-connector.

■ **Ordering guide**

AKD5365 --- AK5365 Evaluation Board  
 (Cable for connecting with printer port of IBM-AT compatible PC and control software are packed with this.)

### FUNCTION

- **DIT with optical output**
- **BNC connector for an external clock input**
- **10pin Header for serial control mode**

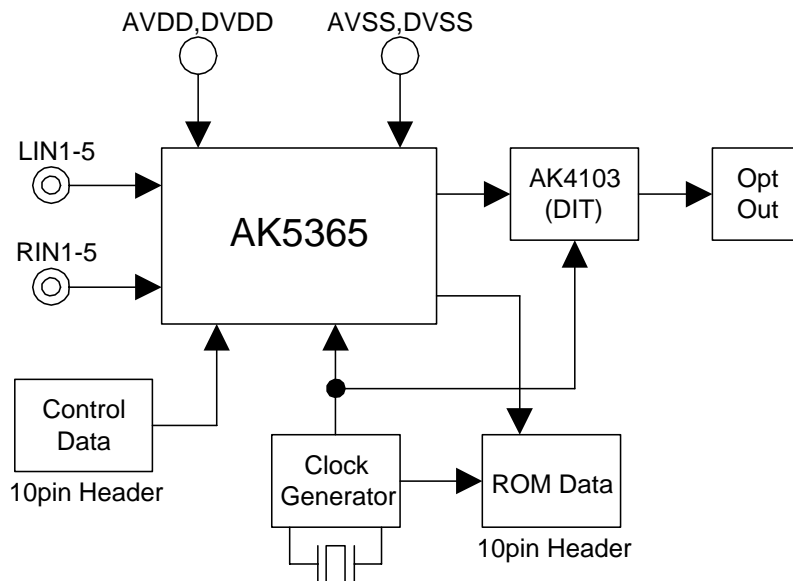

Figure 1. AKD5365 Block Diagram

\* Circuit diagram and PCB layout are attached at the end of this manual.

## 1. Evaluation Board Manual

### ■ Operation sequence

#### 1) Set up the power supply lines.

[AVDD]	(Red)	= 4.75 ~ 5.25V: for AVDD of AK5365 (typ. 5.0V)
[TVDD]	(Orange)	= 3.0 ~ 5.25V: for DVDD of AK5365 (typ. 3.3V)
[D3V]	(Orange)	= 3.0 ~ 5.25V: for 74LVC541 (typ. 3.3V)
[VCC]	(Red)	= 5V: for logic
[AGND]	(Black)	= 0V: for analog ground
[DGND]	(Black)	= 0V: for logic ground

Each supply line should be distributed from the power supply unit.  
D3V and TVDD must be same voltage level.

#### 2) Set up the evaluation mode, jumper pins and DIP switches. (See the followings.)

#### 3) Power on.

The AK5365 and AK4103 should be reset once bringing SW2 = "L" upon power-up.

### ■ Evaluation mode

#### (1) Slave Mode

When evaluating the AK5365 using the AK4103, the setting of the AK5365's audio interface format should be the same as the AK4103's format. The DIF setting of the AK5365 (No.1 of SW1 (I2C) in parallel mode, DIF bit in serial mode) should be the same as the DIF setting of the AK4103 (No.1 of SW3). About the AK5365's audio interface format, refer to AK5365's datasheet. About the AK4103's audio interface format, see Table3.

#### (1-1) A/D evaluation using DIT function of AK4103

PORT1 (DIT) is used. DIT generates audio bi-phase signal from received data and which is output through optical connector (TOTX176). It is possible to connect AKM's D/A converter evaluation boards on the digital-amplifier which equips DIR input. Nothing should be connected to PORT2 (ROM). In case of using external clock through a BNC connector (J13), select EXT on JP8 (CLK) and short JP6 (XTE) and open JP9 (EXT).

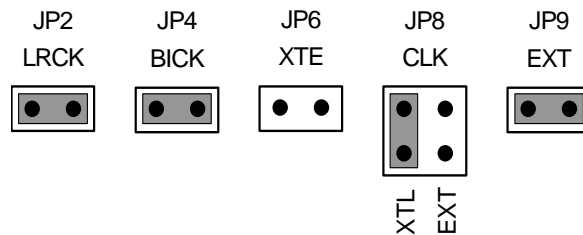

## (2) Master Mode

## (2-1) A/D evaluation using DIT function of AK4103

PORT1 (DIT) is used. DIT generates audio bi-phase signal from received data and which is output through optical connector (TOTX176). It is possible to connect AKM's D/A converter evaluation boards on the digital-amplifier which equips DIR input. Nothing should be connected to PORT2 (ROM). In case of using external clock through a BNC connector (J13), select EXT on JP8 (CLK) and short JP6 (XTE) and open JP9 (EXT).

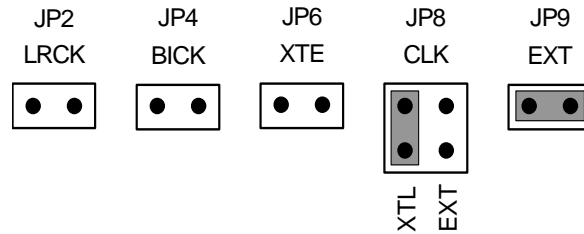

### ■ Other jumper pins set up

1. JP1 (GND): Analog ground and Digital ground  
 OPEN: Separated.  
 SHORT: Common. (The connector "DGND" can be open.) <Default>
2. JP3 (M/S): Select Master/Slave mode for AK5365  
 SLAVE: Slave mode <Default>  
 MASTER: Master mode
3. JP5 (TVDD): Select DVDD for AK5365  
 REG: Supply from regulator  
 TVDD: Supply from TVDD connector <Default>
4. JP7 (MCLK): MCLK Frequency for 74HC4040  
 256: MCLK is 256fs. (=12.288MHz@fs=48kHz) <Default>  
 512: MCLK is 512fs. (=24.576MHz@fs=48kHz)

## ■ DIP Switch set up

[SW1] (MODE1): Setting the evaluation mode for AK5365  
ON is “H”, OFF is “L”. Default is all “L”.

No.	Name	OFF (“L”)	ON (“H”)
1	I2C	Fixed to “L”	
2	CAD0	Fixed to “L”	
3	CAD1	Fixed to “L”	
4	DIF	Fixed to “L”	
5	SEL2	See Table 2	
6	SEL1		
7	SEL0		
8	ALC	ALC Disable	ALC Enable

Table 1. Mode Setting of AK5365

SEL2	SEL1	SEL0	Input Selector	Default
OFF	OFF	OFF	LIN1 / RIN1	
OFF	OFF	ON	LIN2 / RIN2	
OFF	ON	OFF	LIN3 / RIN3	
OFF	ON	ON	LIN4 / RIN4	
ON	OFF	OFF	LIN5 / RIN5	

Table 2. Input Selector

[SW3] (MODE2): Setting the evaluation mode for AK4103  
ON is “H”, OFF is “L”. Default is all “L”.

No.	Name	OFF (“L”)	ON (“H”)
1	DIF	24bit, MSB justified	24bit, I <sup>2</sup> S Compatible
2	CKS1	See Table 4	
3	CKS0		

Table 3. Mode Setting of AK4103

Mode	CKS1	CKS0	MCLK	fs	Default
0	OFF	OFF	256fs	~ 96kHz	
1	OFF	ON	N/A	N/A	
2	ON	OFF	512fs	~ 48kHz	
3	ON	ON	384fs	~ 48kHz	

Table 4. MCLK Frequency Setting of AK4103

## ■ The function of the toggle SW

Upper-side is “H” and lower-side is “L”.

[SW2] (PDN): Resets the AK5365 and AK4103. Keep “H” during normal operation.

[SW4] (SMUTE): Soft mute of AK5365.

■ Serial Control

The AK5365 can be controlled via the printer port (parallel port) of IBM-AT compatible PC. Connect PORT3 (CTRL) with PC by 10-line flat cable packed with the AKD5365. The control software packed with this evaluation board does not support I<sup>2</sup>C control.

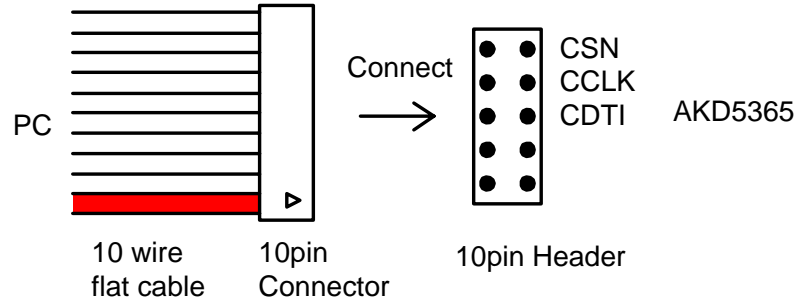

Figure 2. Connect of 10-line flat cable

■ Input/Output Circuits

(1) Input Circuit

Analog signal is input to LIN1-5/RIN1-5 pins via J1 ~ J12 connectors.

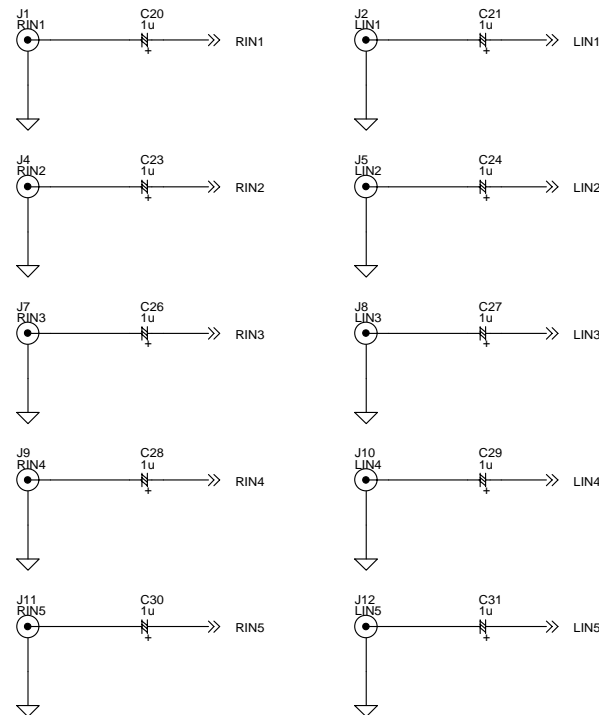

Figure 3. LIN1-5/RIN1-5 Input circuits

The cut-off frequency of the input circuit on this evaluation board is as below. When changing the cut-off frequency, change the constant of the each resistor and capacitor.

- (1) The cut-off frequency of HPF in front of the Pre-Amp:  $f_c = 3.4\text{Hz}$  ( $R = 47\text{k}\Omega$ ,  $C = 1\mu\text{F}$ )
- (2) The cut-off frequency of HPF, which is composed by the input resistance of the IPGAL/R pins and the capacitor of between the Pre-Amp output and the IPGA input:  $f_c = 3.4\text{Hz}$ . ( $R = 10\text{k}\Omega$ ,  $C = 4.7\mu\text{F}$ )

(2) Output Circuit

Signal of LOUT and ROUT pins are output via J3 (LOUT) and J6 (ROUT).

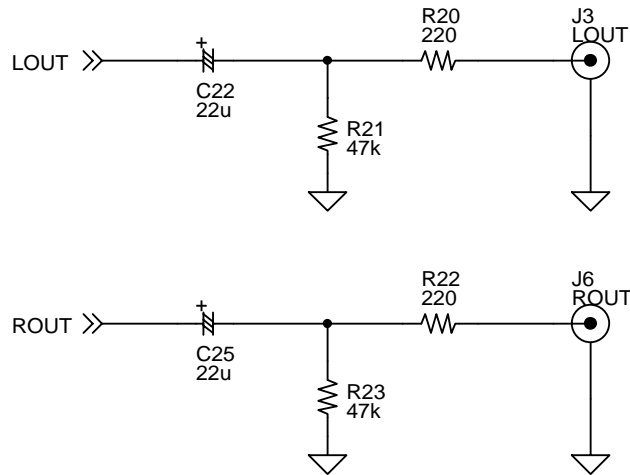

Figure 4. LOUT/ROUT Output circuits

\* AKM assumes no responsibility for the trouble when using the circuit examples.

## Control Software Manual

### ■ Set-up of evaluation board and control software

1. Set up the AKD5365 according to previous term.
2. Connect IBM-AT compatible PC with AKD5365 by 10-line type flat cable (packed with AKD5365). Take care of the direction of 10pin header. (Please install the driver in the CD-ROM when this control software is used on Windows 2000/XP. Please refer "Installation Manual of Control Software Driver by AKM device control software". In case of Windows95/98/ME, this installation is not needed. This control software does not operate on Windows NT.)
3. Insert the CD-ROM labeled "AKD5365 Evaluation Kit" into the CD-ROM drive.
4. Access the CD-ROM drive and double-click the icon of "akd5365.exe" to set up the control program.
5. Then please evaluate according to the follows.

### ■ Operation flow

Keep the following flow.

1. Set up the control program according to explanation above.
2. Click "Port Reset" button.

### ■ Explanation of each buttons

1. [Port Reset]: Set up the USB interface board (AKDUSBIF-A).
2. [Write default]: Initialize the register of AK5365.
3. [All Write]: Write all registers that is currently displayed.
4. [Function1]: Dialog to write data by keyboard operation.
5. [Function2]: Dialog to write data by keyboard operation.
6. [Function3]: The sequence of register setting can be set and executed.
7. [Function4]: The sequence that is created on [Function3] can be assigned to buttons and executed.
8. [Function5]: The register setting that is created by [SAVE] function on main window can be assigned to buttons and executed.
9. [SAVE]: Save the current register setting.
10. [OPEN]: Write the saved values to all register.
11. [Write]: Dialog to write data by mouse operation.

### ■ Indication of data

Input data is indicated on the register map. Red letter indicates "H" or "1" and blue one indicates "L" or "0". Blank is the part that is not defined in the datasheet.

## ■ Explanation of each dialog

### 1. [Write Dialog]: Dialog to write data by mouse operation

There are dialogs corresponding to each register.

Click the [Write] button corresponding to each register to set up the dialog. If you check the check box, data becomes “H” or “I”. If not, “L” or “O”.

When writing the input data to AK5365, click [OK] button. If not, click [Cancel] button.

### 2. [Function1 Dialog]: Dialog to write data by keyboard operation

Address Box: Input registers address in 2 figures of hexadecimal.

Data Box: Input registers data in 2 figures of hexadecimal.

When writing the input data to AK5365, click [OK] button. If not, click [Cancel] button.

### 3. [Function2 Dialog]: Dialog to evaluate ATT

This is a dialog corresponding to address: 04H, 05H.

Address Box: Input registers address in 2 figures of hexadecimal.

Start Data Box: Input starts data in 2 figures of hexadecimal.

End Data Box: Input end data in 2 figures of hexadecimal.

Interval Box: Data is written to AK5365 by this interval.

Step Box: Data changes by this step.

Mode Select Box:

With checking this check box, data reaches end data, and returns to start data.

[Example] Start Data = 00, End Data = 09

Data flow: 00 01 02 03 04 05 06 07 08 09 09 08 07 06 05 04 03 02 01 00

Without checking this check box, data reaches end data, but does not return to start data.

[Example] Start Data = 00, End Data = 09

Data flow: 00 01 02 03 04 05 06 07 08 09

When writing the input data to AK5365, click [OK] button. If not, click [Cancel] button.

## 4. [Save] and [Open]

### 4-1. [Save]

Save the current register setting data. The extension of file name is “akr”.

(Operation flow)

- (1) Click [Save] Button.
- (2) Set the file name and push [Save] Button. The extension of file name is “akr”.

### 4-2. [Open]

The register setting data saved by [Save] is written to AK5365. The file type is the same as [Save].

(Operation flow)

- (1) Click [Open] Button.
- (2) Select the file (\*.akr) and Click [Open] Button.

**5. [Function3 Dialog]**

The sequence of register setting can be set and executed.

- (1) Click [F3] Button.
- (2) Set the control sequence.  
Set the address, Data and Interval time. Set “-1” to the address of the step where the sequence should be paused.
- (3) Click [Start] button. Then this sequence is executed.

The sequence is paused at the step of Interval="-1". Click [START] button, the sequence restarts from the paused step.

This sequence can be saved and opened by [Save] and [Open] button on the [Function3] window. The extension of file name is “aks”.

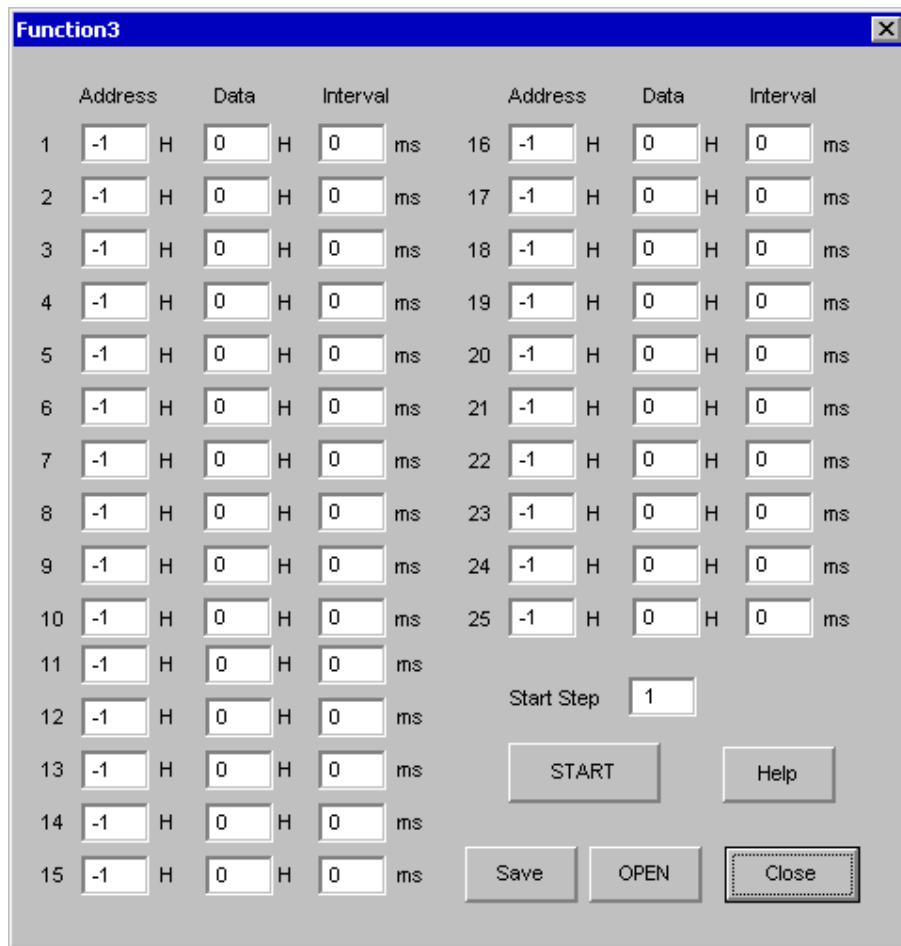

**Figure 1. Window of [F3]**

6. [Function4 Dialog]

The sequence that is created on [Function3] can be assigned to buttons and executed. When [F4] button is clicked, the window as shown in Figure 2 opens.

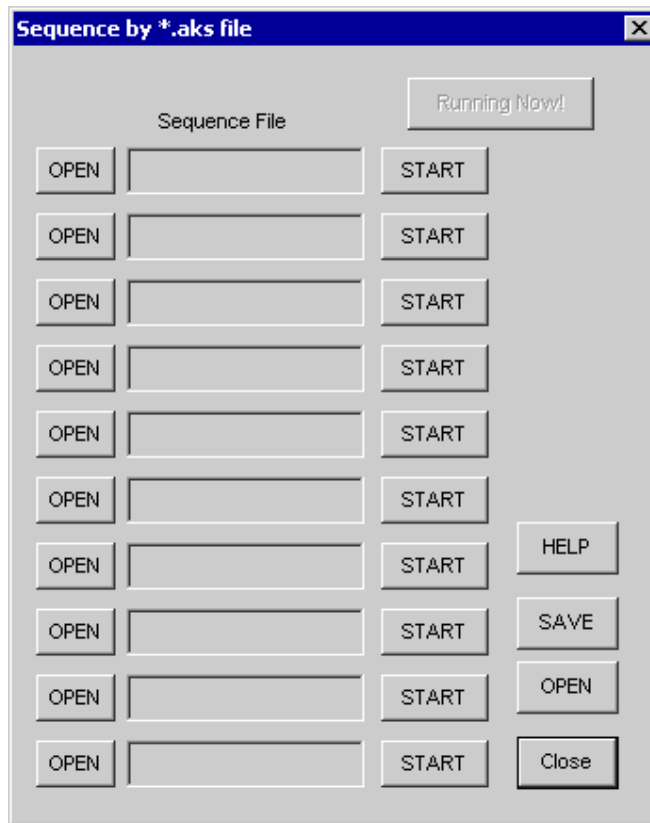
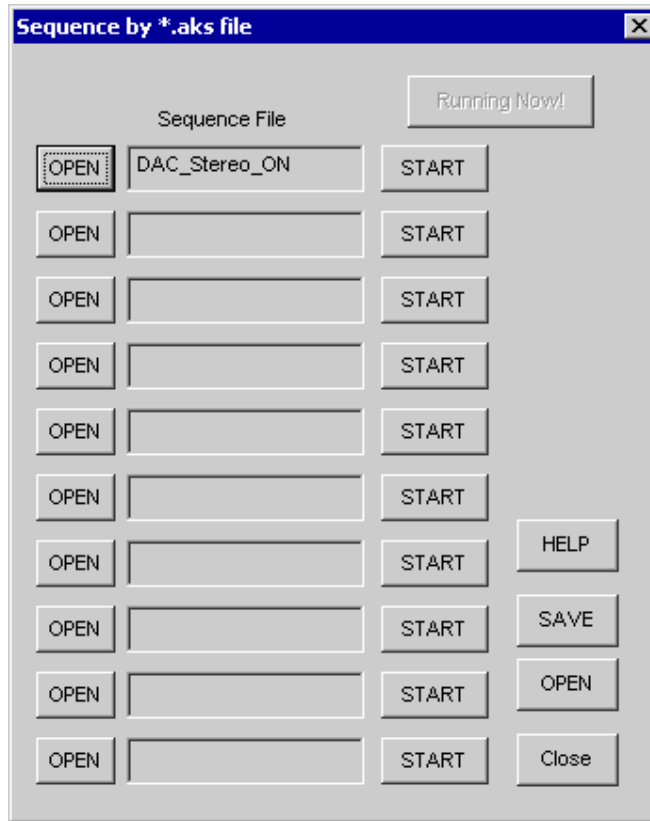

Figure 2. [F4] window

**6-1. [OPEN] buttons on left side and [START] buttons**

(1) Click [OPEN] button and select the sequence file (\*.aks).

The sequence file name is displayed as shown in Figure 3.



**Figure 3. [F4] window(2)**

(2) Click [START] button, then the sequence is executed.

**6-2. [SAVE] and [OPEN] buttons on right side**

[SAVE]: The sequence file names can assign be saved. The file name is \*.ak4.

[OPEN]: The sequence file names assign that are saved in \*.ak4 are loaded.

**6-3. Note**

(1) [Function4] doesn't support the pause function of sequence function.

(2) All files need to be in same folder used by [SAVE] and [OPEN] function on right side.

(3) When the sequence is changed in [Function3], the file should be loaded again in order to reflect the change.

## 7. [Function5 Dialog]

The register setting that is created by [SAVE] function on main window can be assigned to buttons and executed. When [F5] button is clicked, the following window as shown in Figure 4 opens.

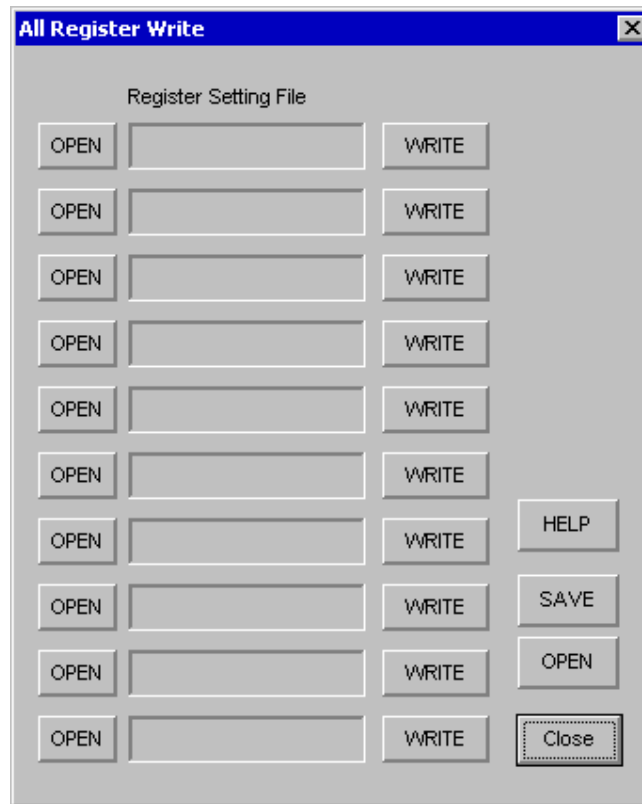

Figure 4. [F5] window

### 7-1. [OPEN] buttons on left side and [WRITE] button

- (1) Click [OPEN] button and select the register setting file (\*.akr).
- (2) Click [WRITE] button, then the register setting is executed.

### 7-2. [SAVE] and [OPEN] buttons on right side

[SAVE]: The register setting file names assign can be saved. The file name is \*.ak5.

[OPEN]: The register setting file names assign that are saved in \*.ak5 are loaded.

### 7-3. Note

- (1) All files need to be in same folder used by [SAVE] and [OPEN] function on right side.
- (2) When the register setting is changed by [Save] Button in main window, the file should be loaded again in order to reflect the change.

<b>MEASUREMENT RESULTS</b>
----------------------------

## [Measurement condition]

- Measurement unit : Audio Precision, System Two Cascade
- MCLK : 256fs
- BICK : 64fs
- fs : 48kHz, 96kHz
- Bit : 24bit
- Power Supply : AVDD = 5.0V, DVDD = 3.3V
- Interface : DIT
- Temperature : Room
- External Condition : Input resistor (Ri) = 47k $\Omega$ , Feedback resistor (Rf) = 24k $\Omega$
- IPGA Gain : 0dB

Parameter		Result (Lch / Rch)	Unit
Pre-Amp Characteristics:			
S/(N+D)		105.8 / 102.5	dB
S/N (A-weighted)		108.6 / 108.6	dB
ADC Analog Input Characteristics: LIN1/RIN1 → Pre-Amp → IPGA → ADC, IPGA=0dB, ALC=OFF			
S/(N+D) (-0.5dB Input)	fs=48kHz	95.6 / 96.6	dB
	fs=96kHz	91.2 / 91.9	dB
D-Range (-60dB Input)	fs=48kHz, A-weighted	103.3 / 103.4	dB
	fs=96kHz	98.6 / 98.6	dB
S/N	fs=48kHz, A-weighted	103.3 / 103.4	dB
	fs=96kHz	98.6 / 98.6	dB
Interchannel Isolation		115.5 / 116.5	dB

[ADC Plot : fs=48kHz]

AK5365 THD+N vs. Input Level  
AVDD=5.0V, DVDD=3.3V, fs=48kHz, fin=1 kHz

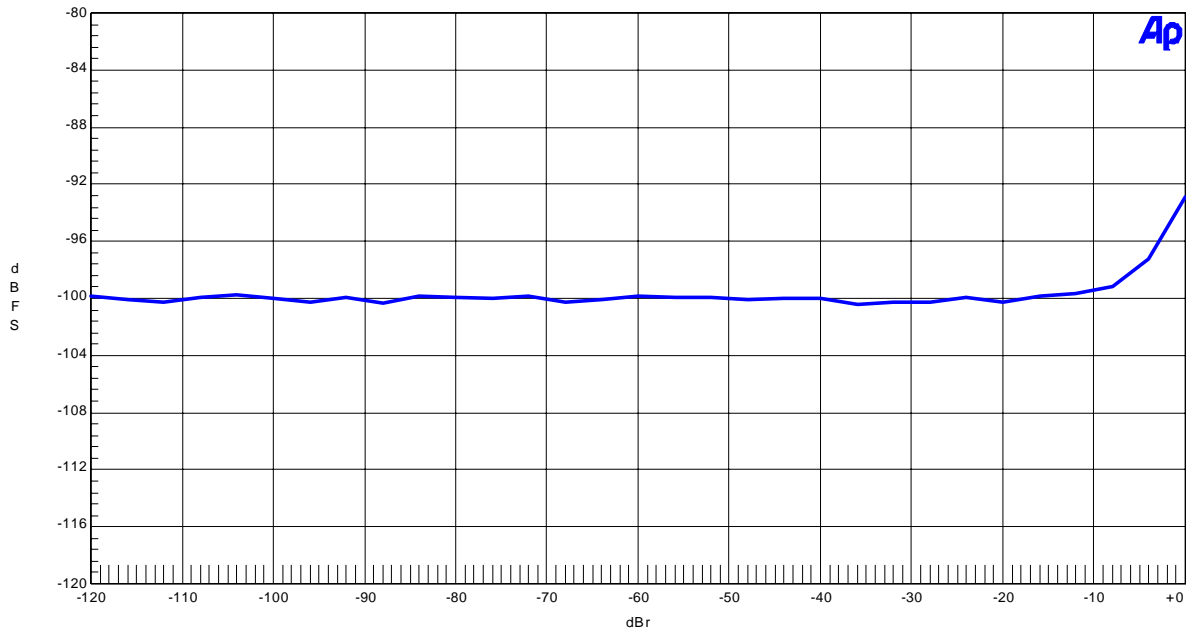

Figure 1. THD+N vs. Input Level

AK5365 THD+N vs. Input Frequency  
AVDD=5.0V, DVDD=3.3V, fs=48kHz, Input=-0.5dBr

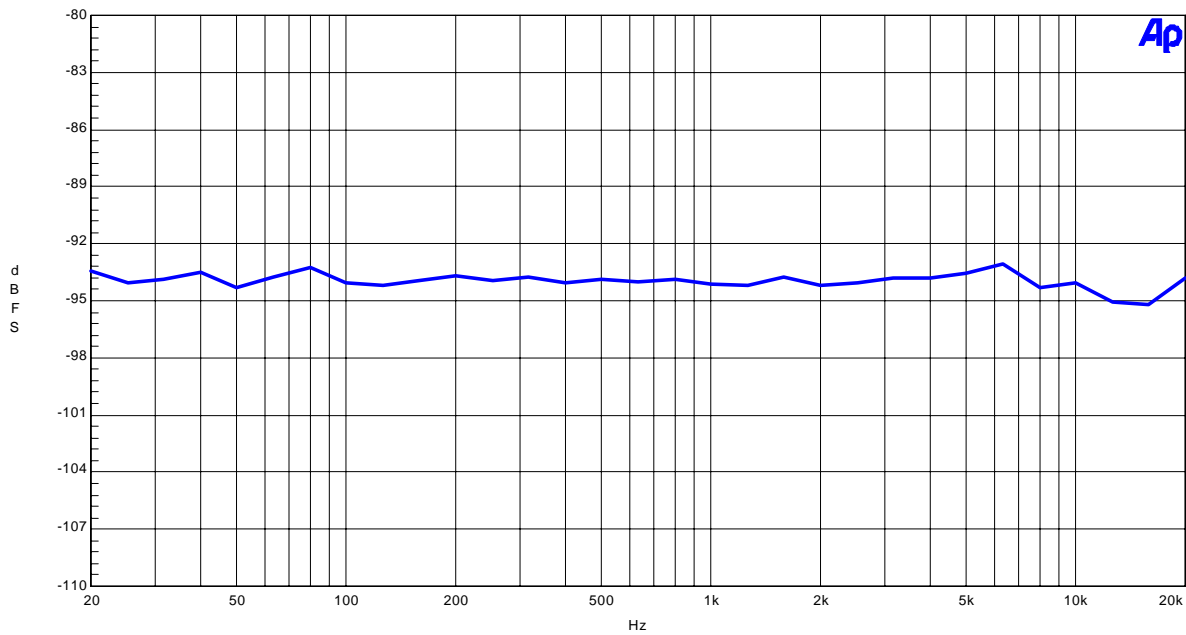

Figure 2. THD+N vs. Input Frequency

AK5365 Linearity  
AVDD=5.0V, DVDD=3.3V, fs=48kHz, fin=1kHz

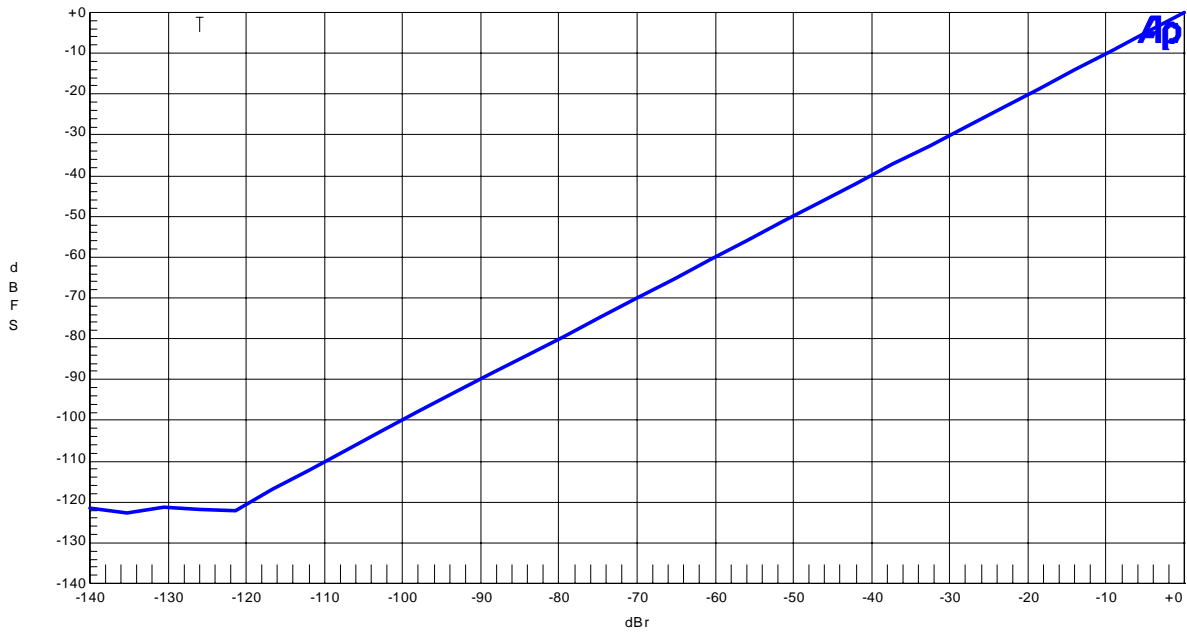

Figure 3. Linearity

AK5365 Frequency Response  
AVDD=5.0V, DVDD=3.3V, fs=48kHz, Input=0dBr

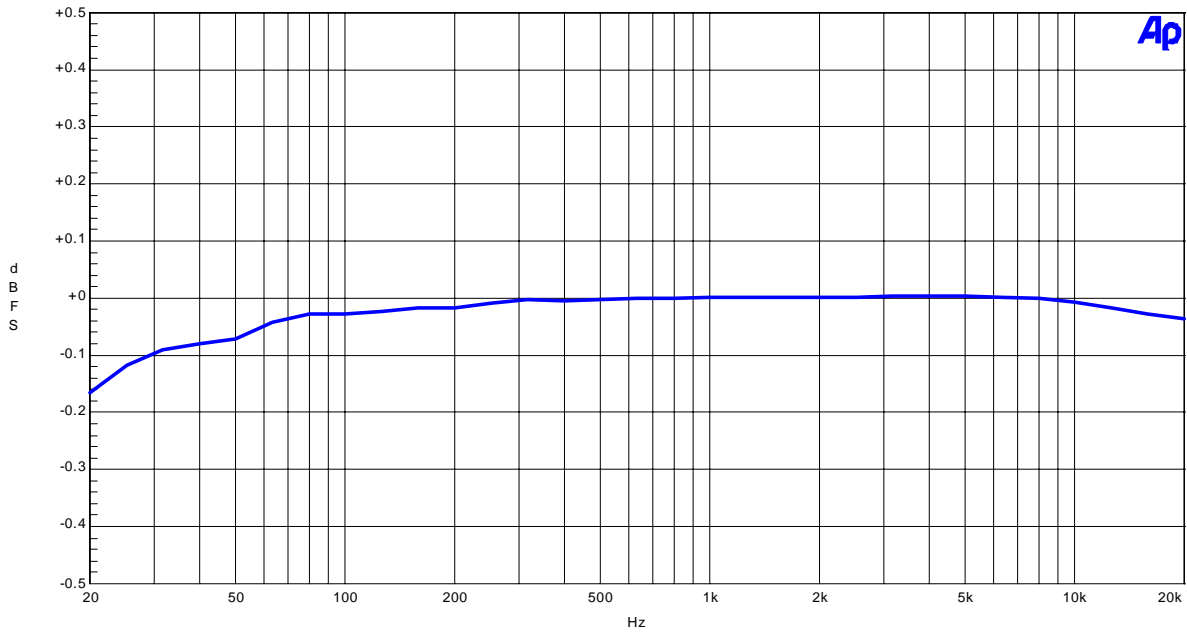

Figure 4. Frequency Response

AK5365 Crosstalk  
AVDD=5.0V, DVDD=3.3V, fs=48kHz, Input=-0.5dB

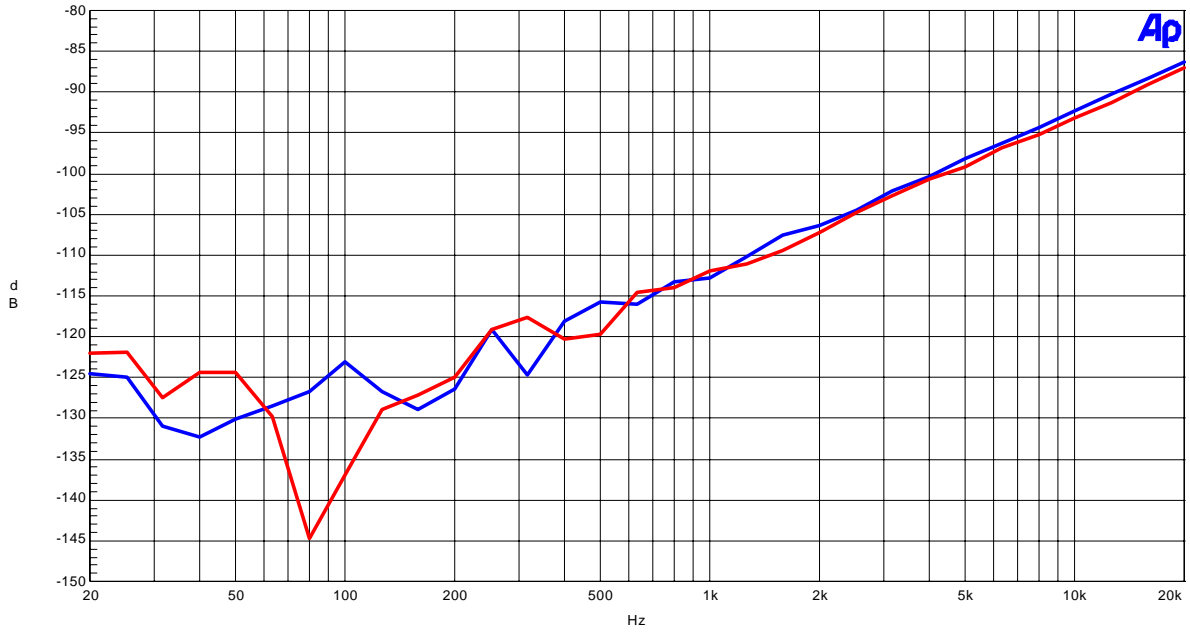

Figure 5. Crosstalk

AK5365 FFT Plot  
AVDD=5.0V, DVDD=3.3V, fs=48kHz, Input=-0.5dB, fin=1kHz

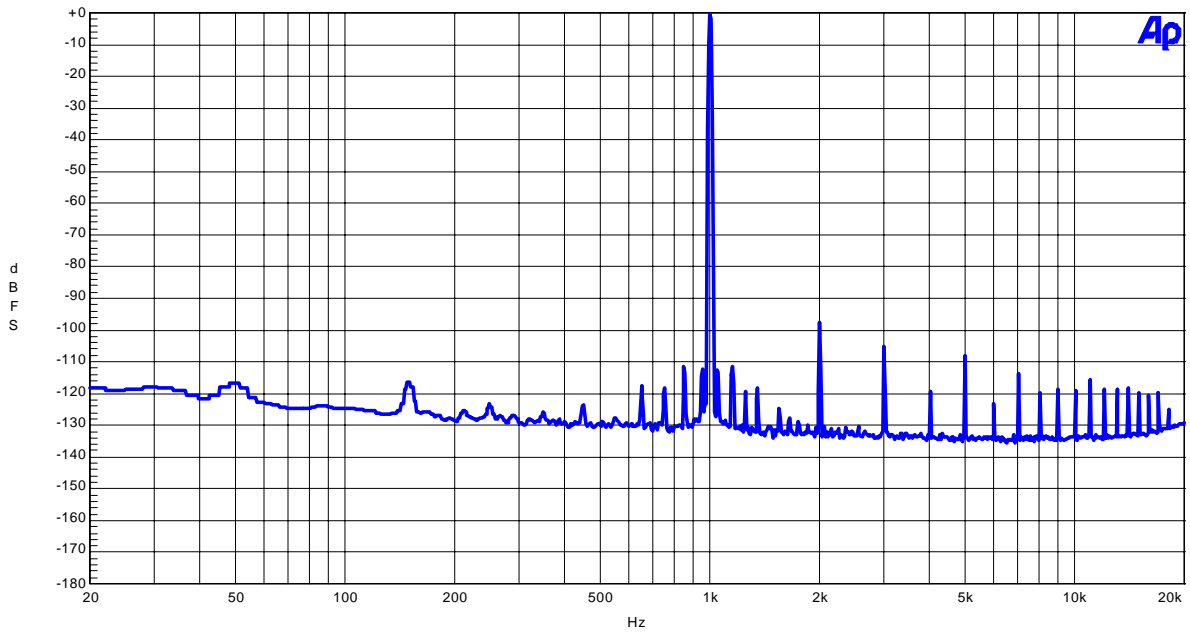

Figure 6. FFT Plot

AK5365 FFT Plot  
AVDD=5.0V, DVDD=3.3V, fs=48kHz, Input=-60dB, fin=1kHz

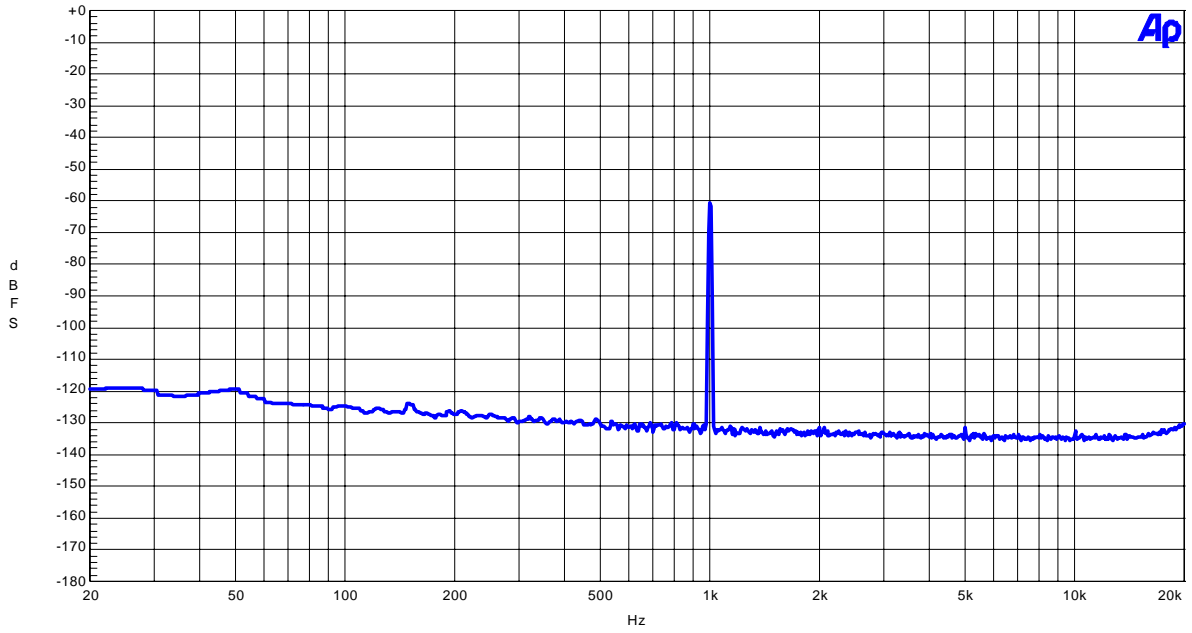

Figure 7. FFT Plot

AK5365 FFT Plot  
AVDD=5.0V, DVDD=3.3V, fs=48kHz, fin=None

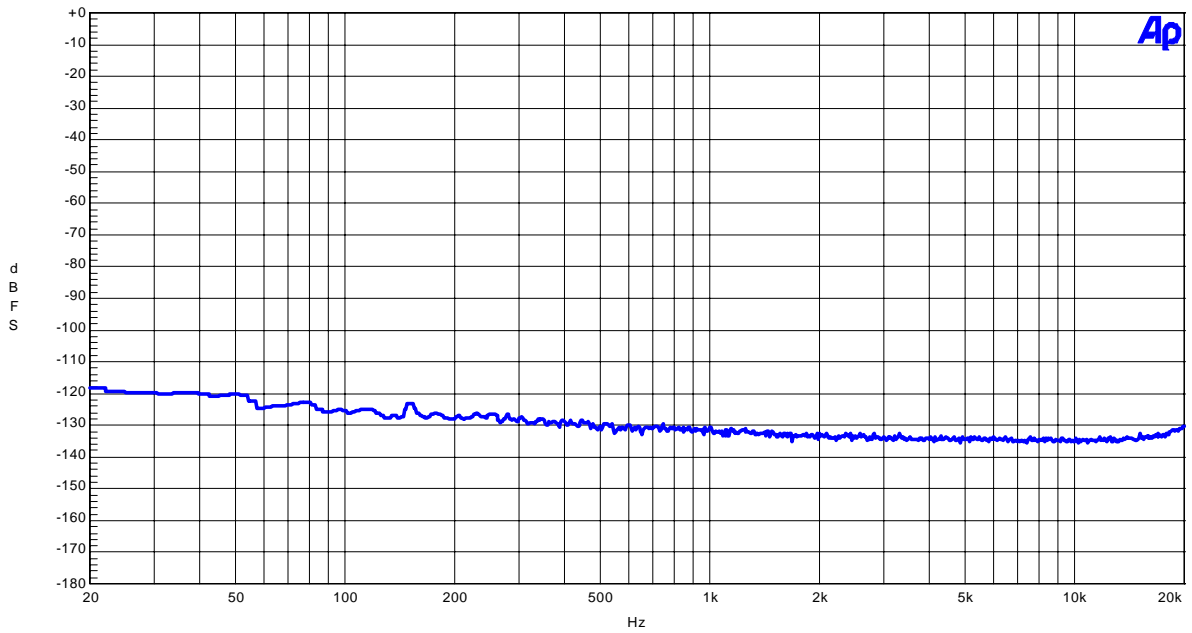

Figure 8. FFT Plot

[ADC Plot : fs=96kHz]

AK5365 THD+N vs. Input Level  
AVDD=5.0V, DVDD=3.3V, fs=96kHz, fin=1kHz

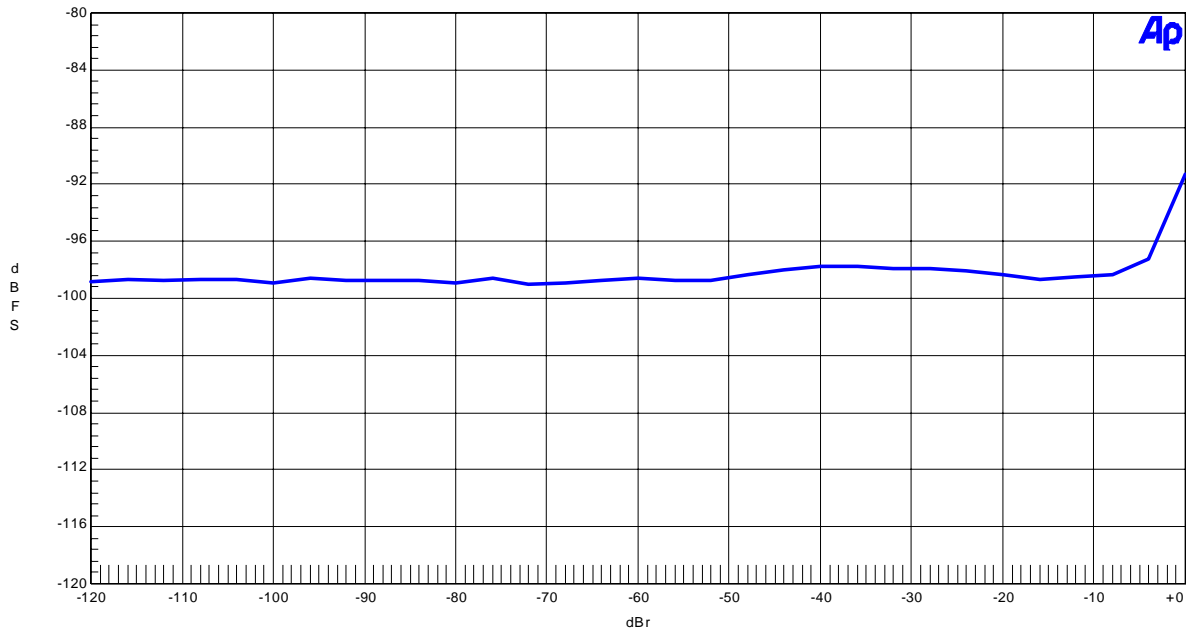

Figure 9. THD+N vs. Input Level

AK5365 THD+N vs. Input Frequency  
AVDD=5.0V, DVDD=3.3V, fs=96kHz, Input=-0.5dBr

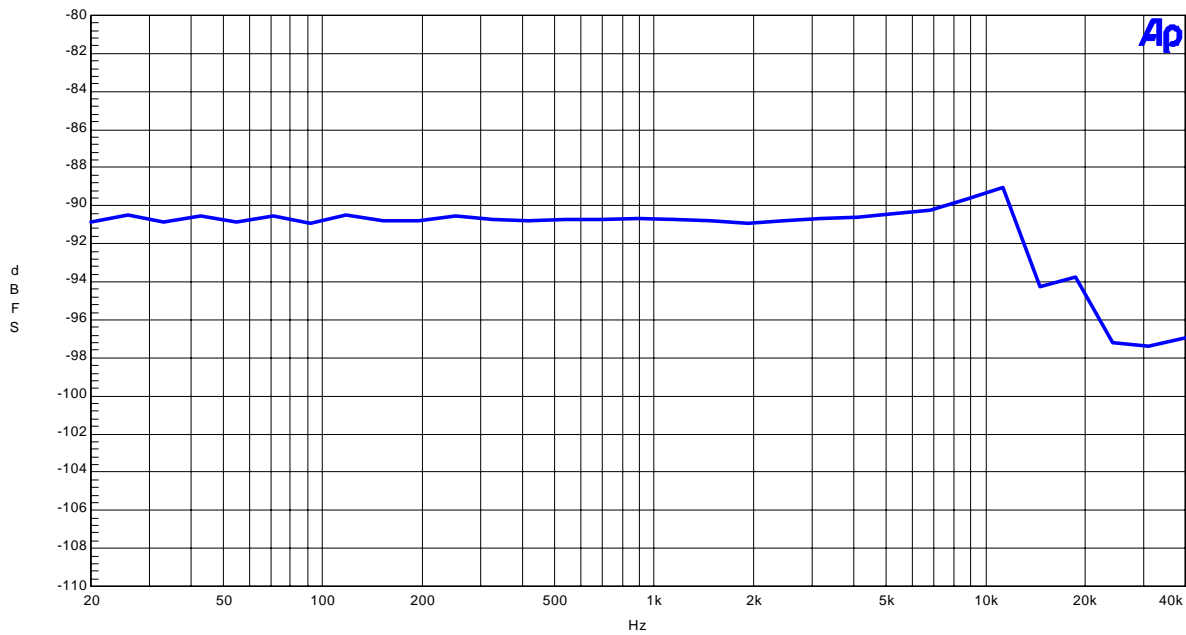

Figure 10. THD+N vs. Input Frequency

AK5365 Linearity  
AVDD=5.0V, DVDD=3.3V, fs=96kHz, fin=1kHz

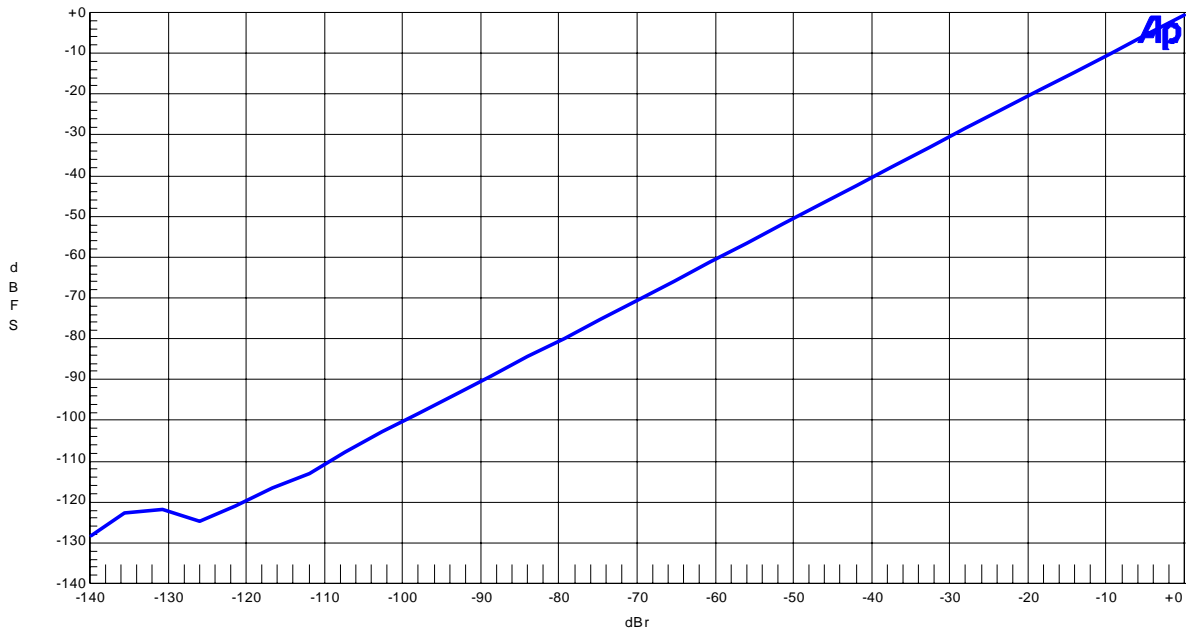

Figure 11. Linearity

AK5365 Frequency Response  
AVDD=5.0V, DVDD=3.3V, fs=96kHz, Input=0dB

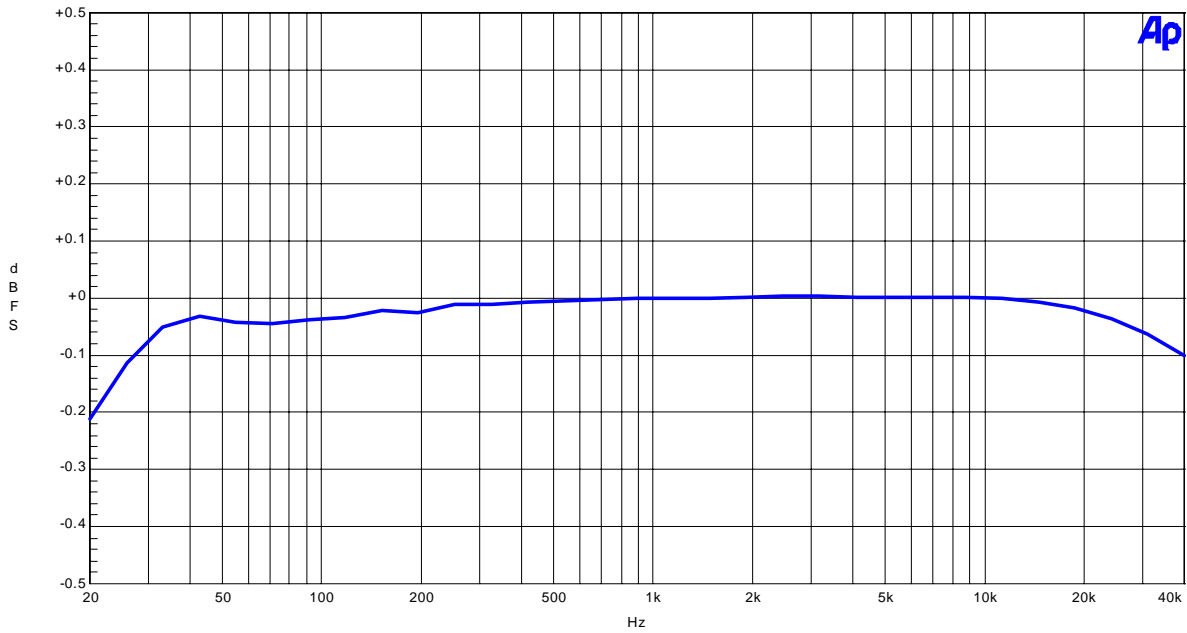

Figure 12. Frequency Response

AK5365 Crosstalk  
AVDD=5.0V, DVDD=3.3V, fs=96kHz, Input=-0.5dB

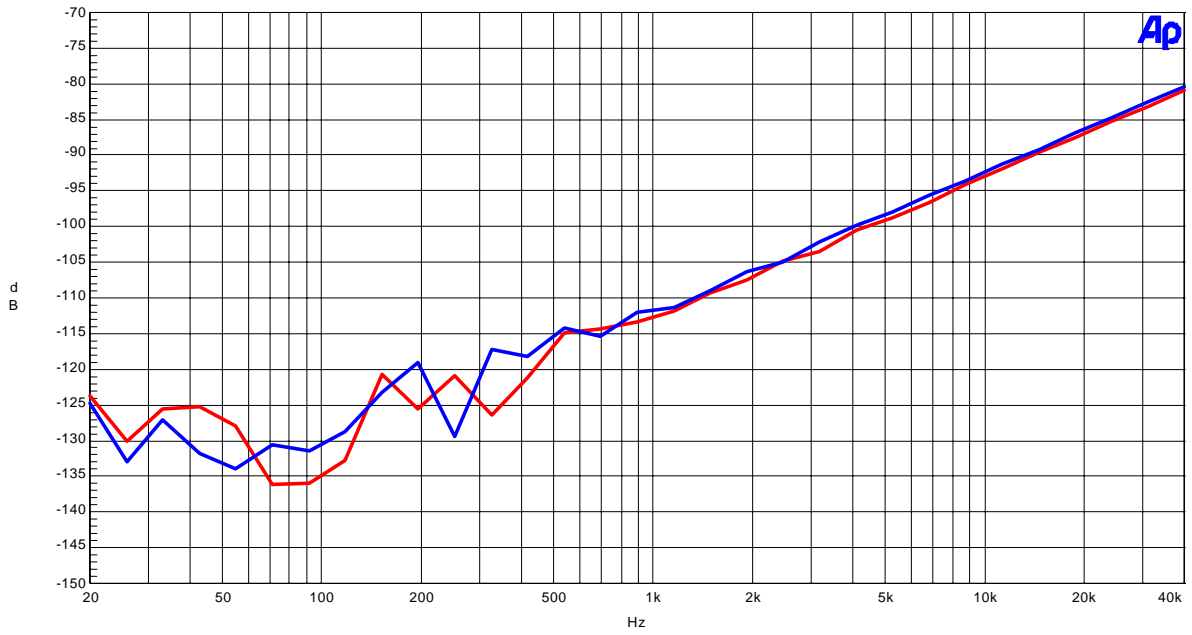

Figure 13. Crosstalk

AK5365 FFT Plot  
AVDD=5.0V, DVDD=3.3V, fs=96kHz, Input=-0.5dB, fin=1kHz

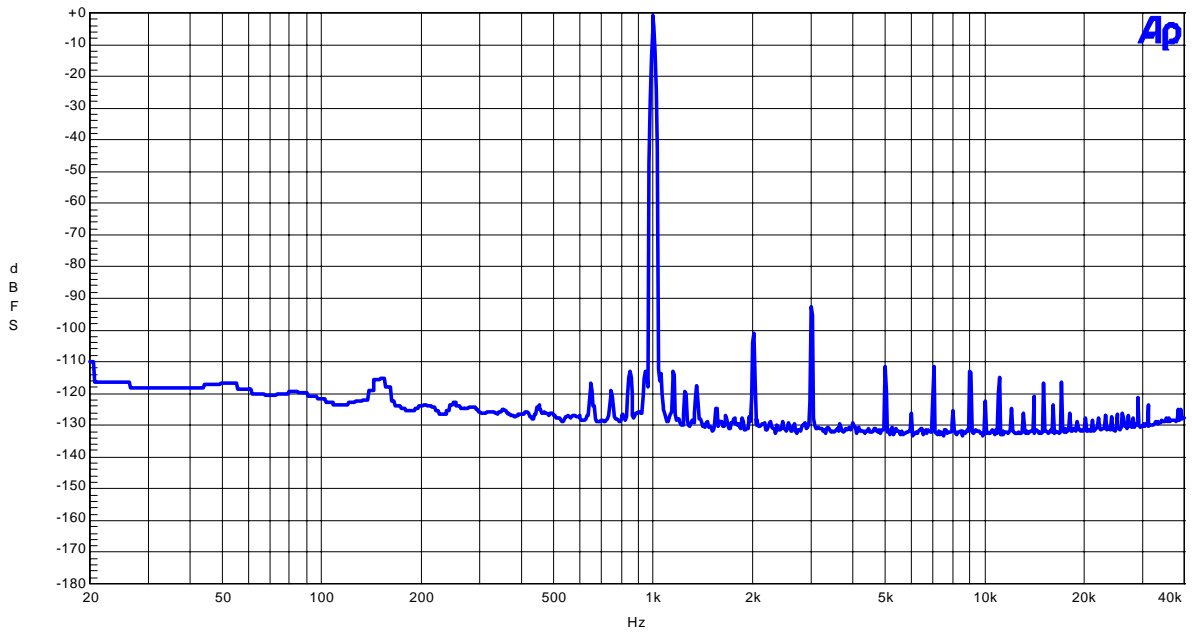

Figure 14. FFT Plot

AK5365 FFT Plot  
AVDD=5.0V, DVDD=3.3V, fs=96kHz, Input=-60dB, fin=1kHz

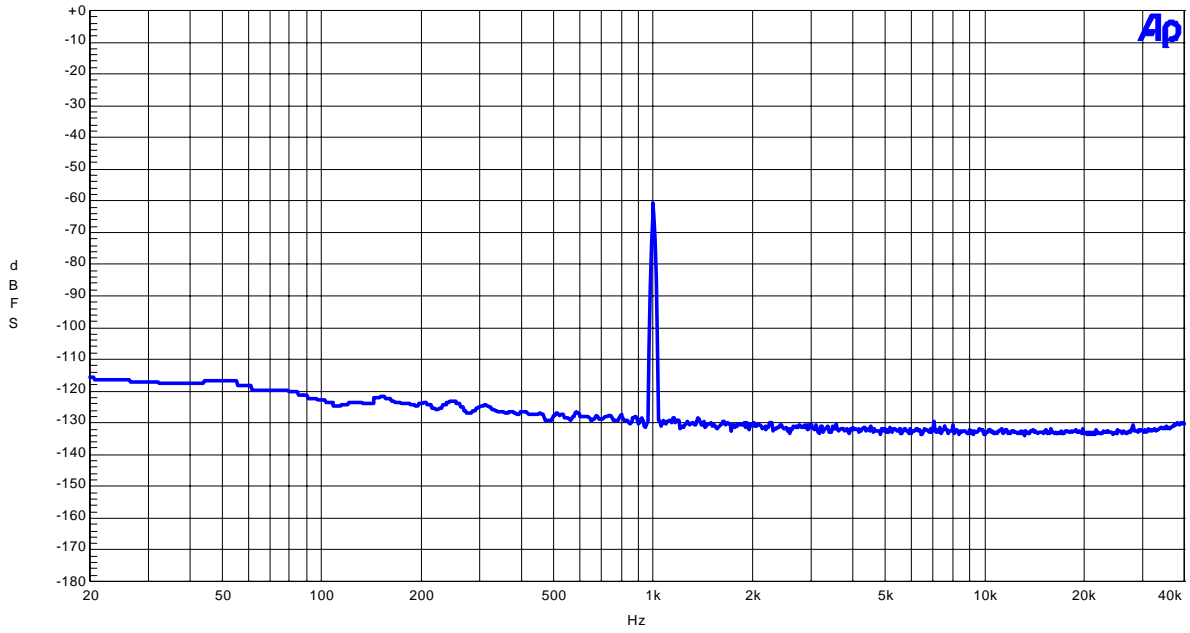

Figure 15. FFT Plot

AK5365 FFT Plot  
AVDD=5.0V, DVDD=3.3V, fs=96kHz, fin=None

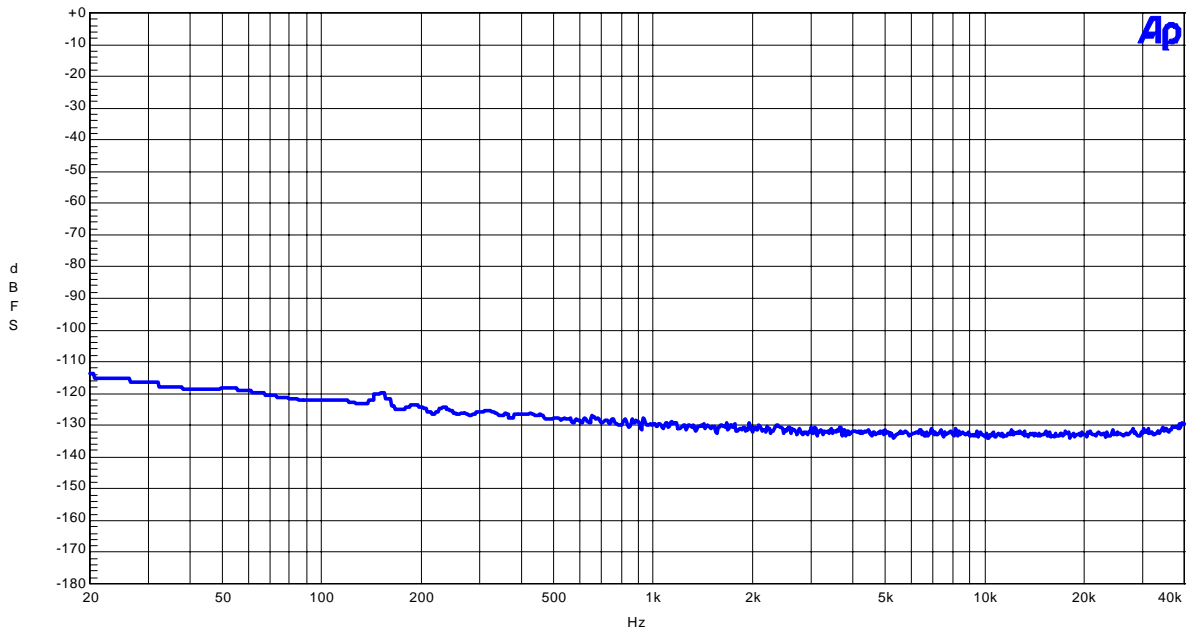

Figure 16. FFT Plot

<b>Revision History</b>
-------------------------

Date (YY/MM/DD)	Manual Revision	Board Revision	Reason	Contents
02/04/25	KM068900	0	First Edition	
06/08/29	KM068901	1	Circuit Change	C32, C33: open→5p

IMPORTANT NOTICE

- These products and their specifications are subject to change without notice. Before considering any use or application, consult the Asahi Kasei Microsystems Co., Ltd. (AKM) sales office or authorized distributor concerning their current status.
- AKM assumes no liability for infringement of any patent, intellectual property, or other right in the application or use of any information contained herein.
- Any export of these products, or devices or systems containing them, may require an export license or other official approval under the law and regulations of the country of export pertaining to customs and tariffs, currency exchange, or strategic materials.
- AKM products are neither intended nor authorized for use as critical components in any safety, life support, or other hazard related device or system, and AKM assumes no responsibility relating to any such use, except with the express written consent of the Representative Director of AKM. As used here:
  - (a) A hazard related device or system is one designed or intended for life support or maintenance of safety or for applications in medicine, aerospace, nuclear energy, or other fields, in which its failure to function or perform may reasonably be expected to result in loss of life or in significant injury or damage to person or property.
  - (b) A critical component is one whose failure to function or perform may reasonably be expected to result, whether directly or indirectly, in the loss of the safety or effectiveness of the device or system containing it, and which must therefore meet very high standards of performance and reliability.
- It is the responsibility of the buyer or distributor of an AKM product who distributes, disposes of, or otherwise places the product with a third party to notify that party in advance of the above content and conditions, and the buyer or distributor agrees to assume any and all responsibility and liability for and hold AKM harmless from any and all claims arising from the use of said product in the absence of such notification.

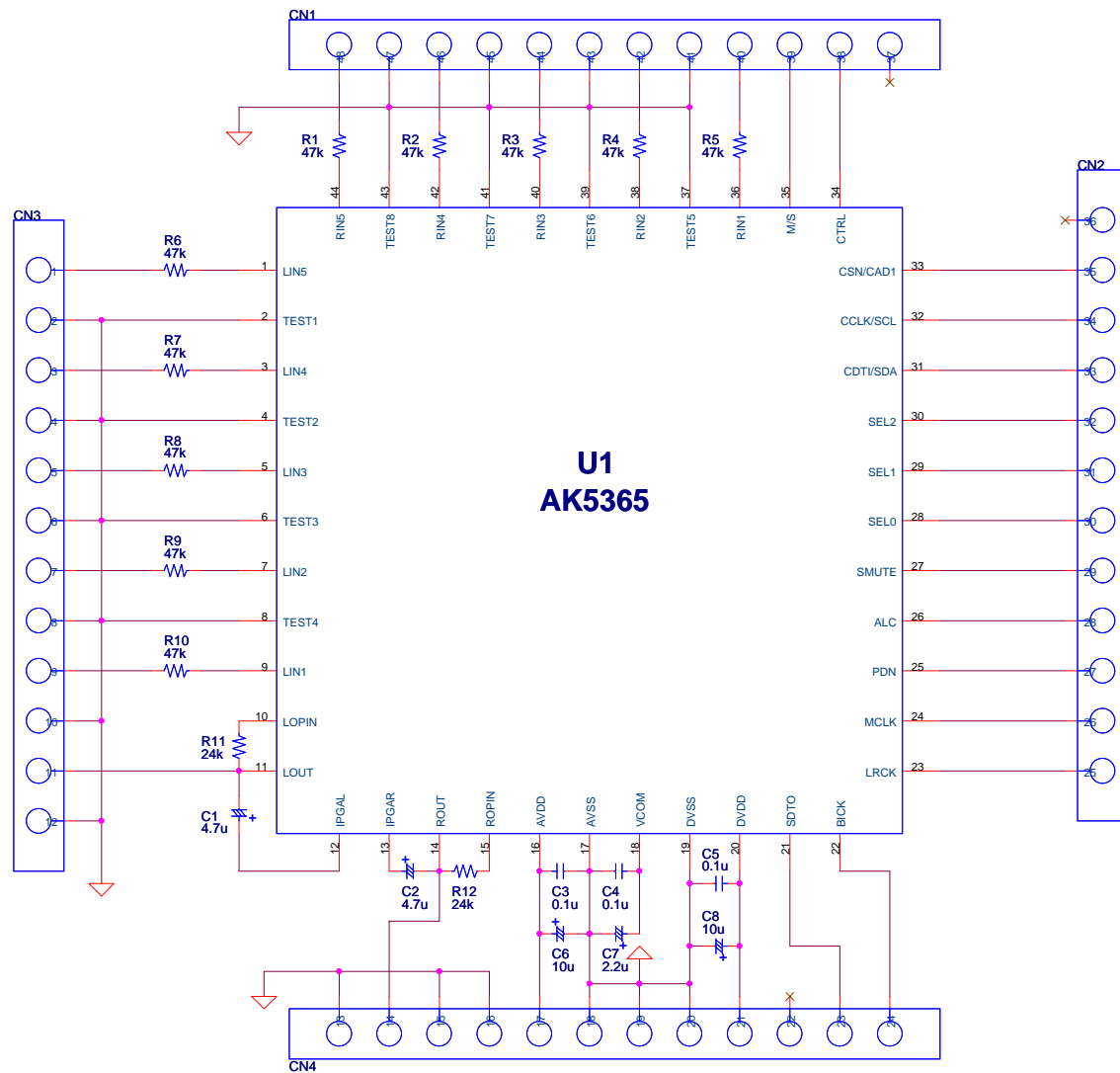

Title		
<b>AKD5365 Rev.A 44LQFP</b>		
Size	Document Number	Rev
A3	<b>AK5365</b>	1
Date:	Tuesday, August 29, 2006	Sheet 1 of 1

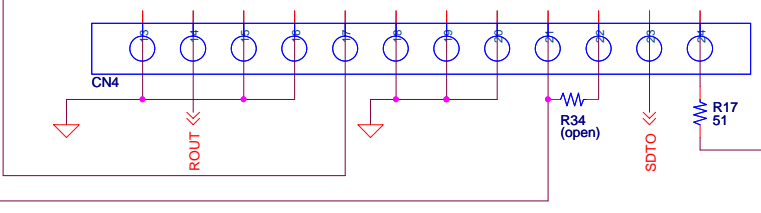
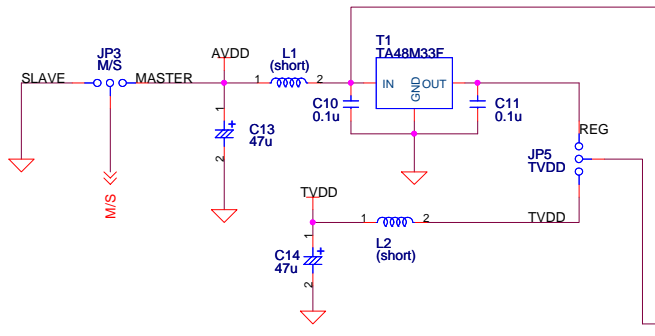
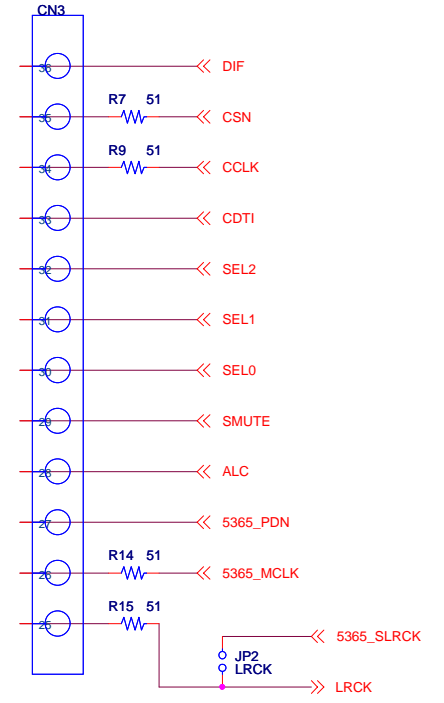
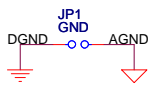
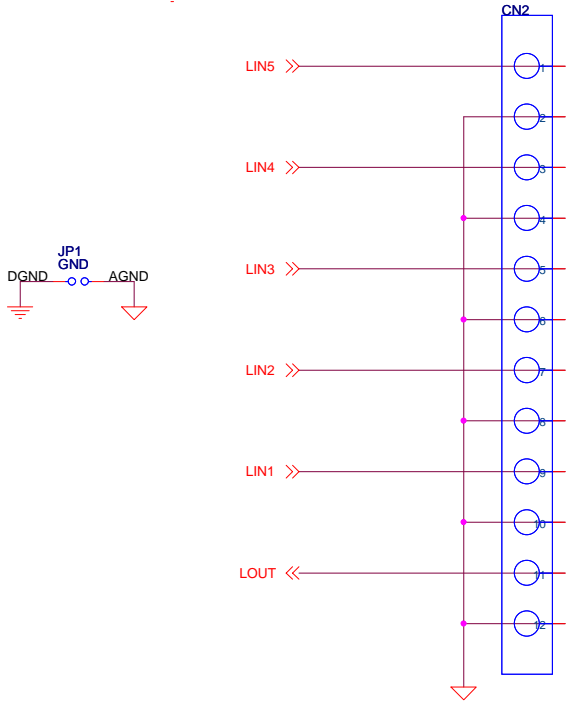
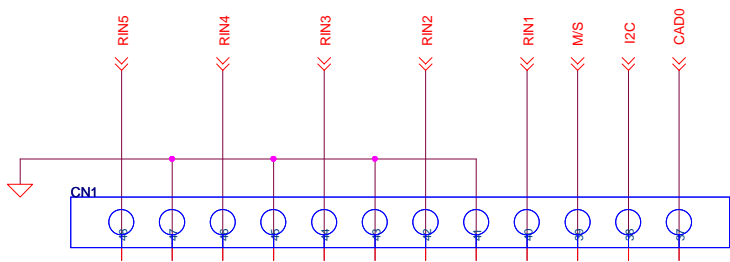
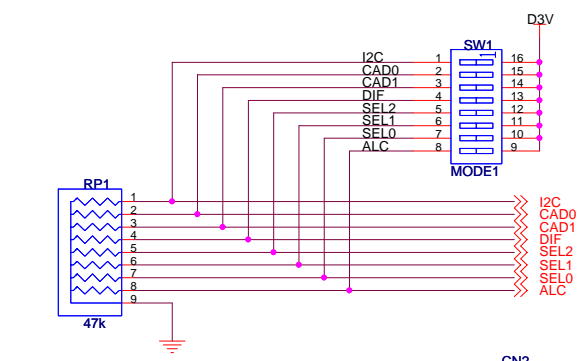

Title			<b>AKD5365 Rev.A</b>
Size	Document Number	Rev	
A3	<b>AK5365</b>	1	1
Date:	Tuesday, August 29, 2006	Sheet	1 of 4

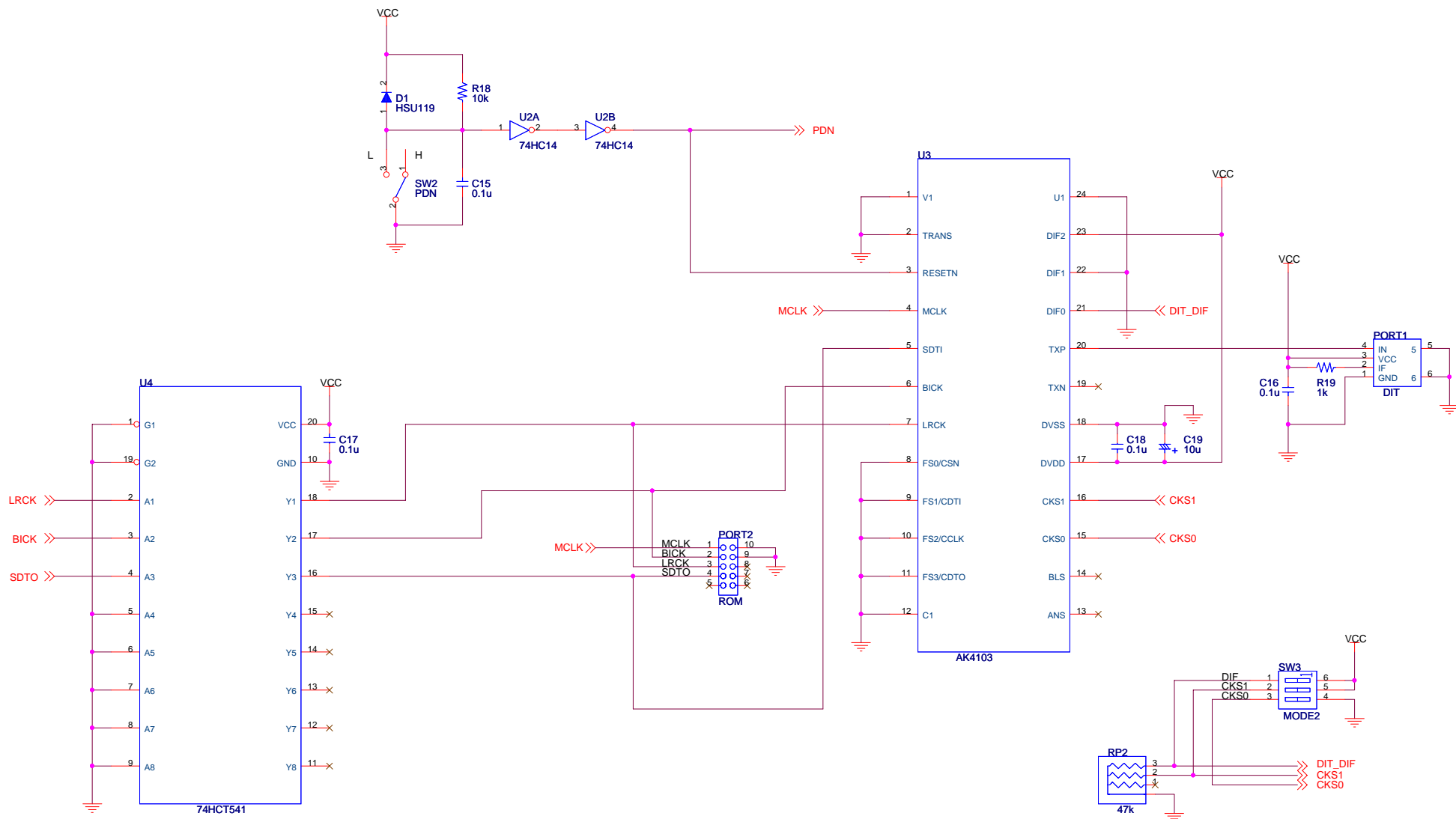

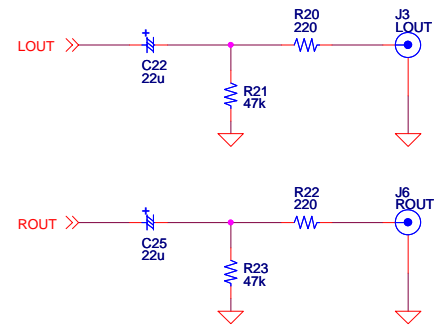
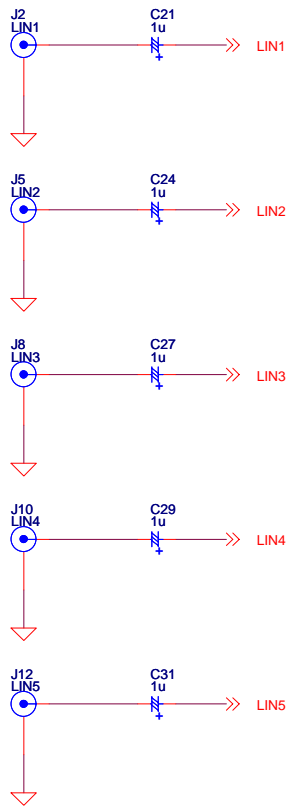
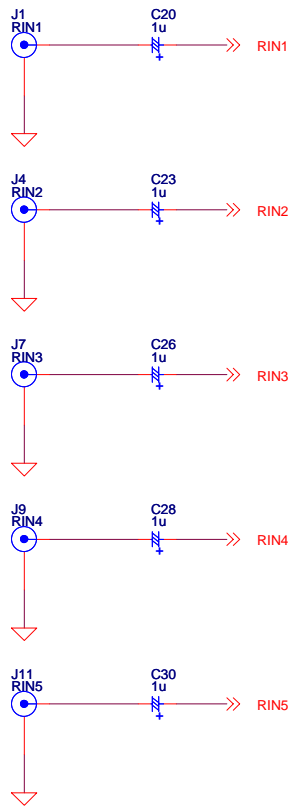

Title			<b>AKD5365 Rev.A</b>	
Size	Document Number	<b>Input/Output</b>		Rev
A3				<b>1</b>
Date: Tuesday, August 29, 2006		Sheet	3	of 4



# AKM AKD5365 Rev.A 44 Sub

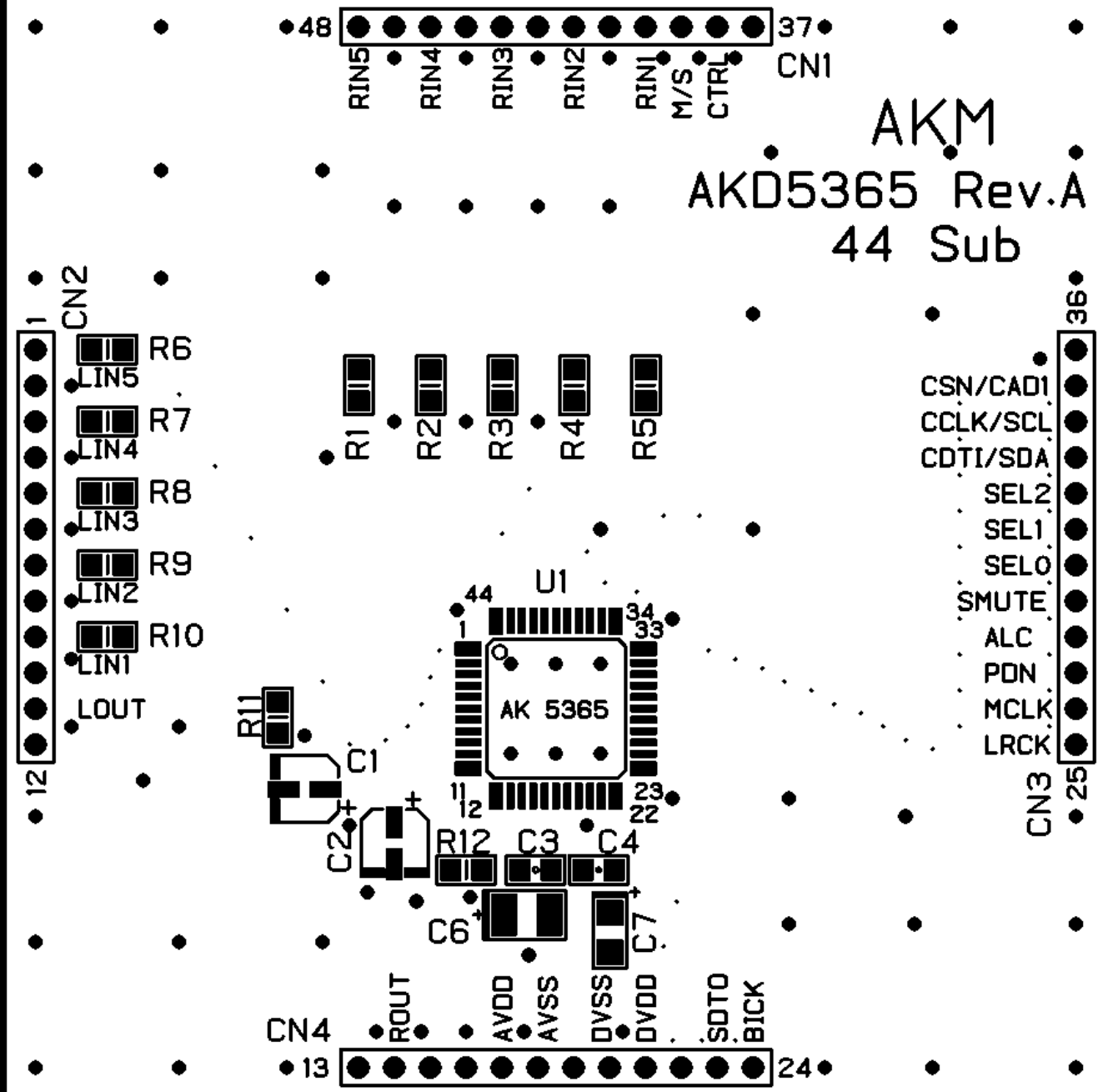

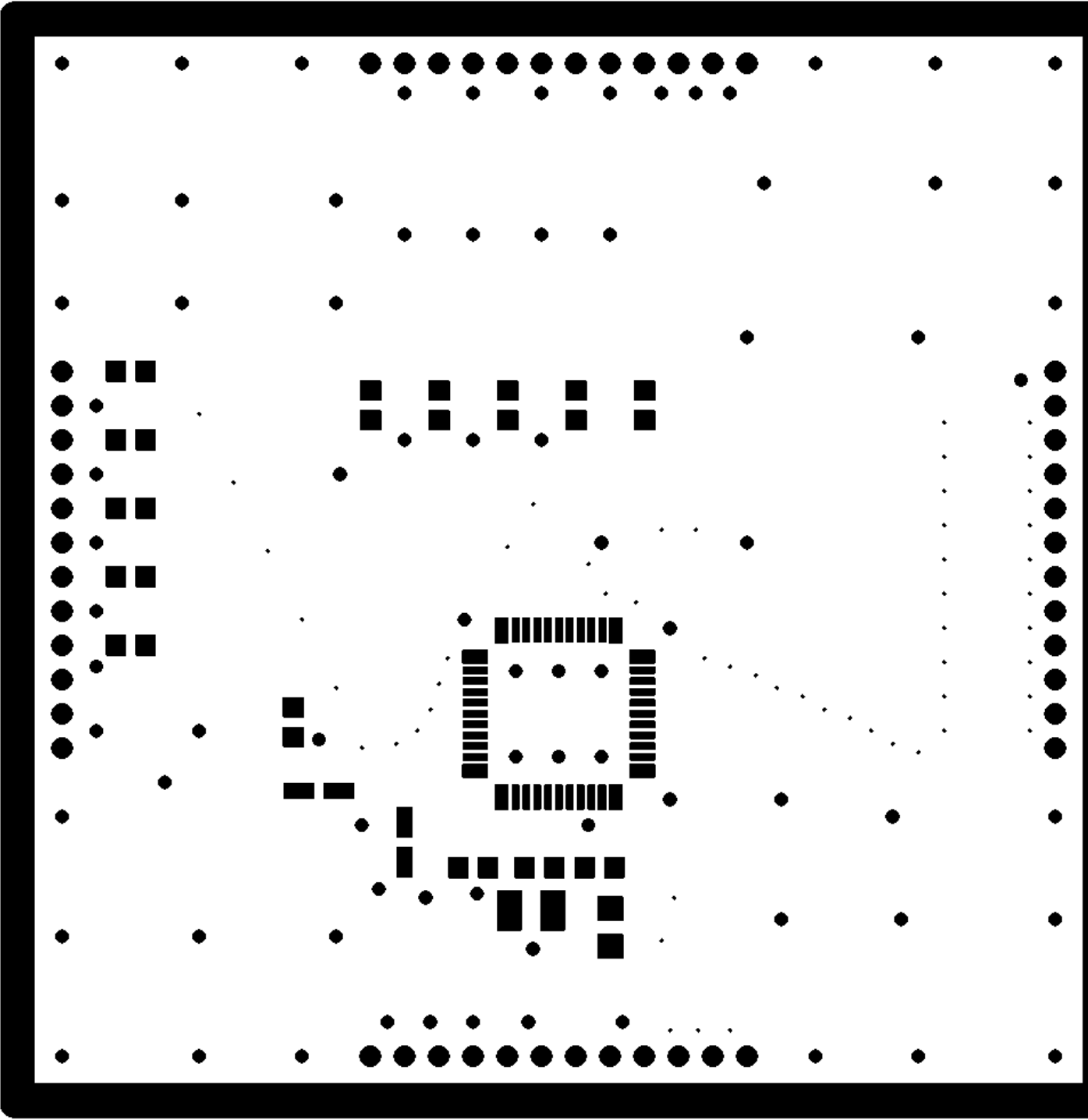

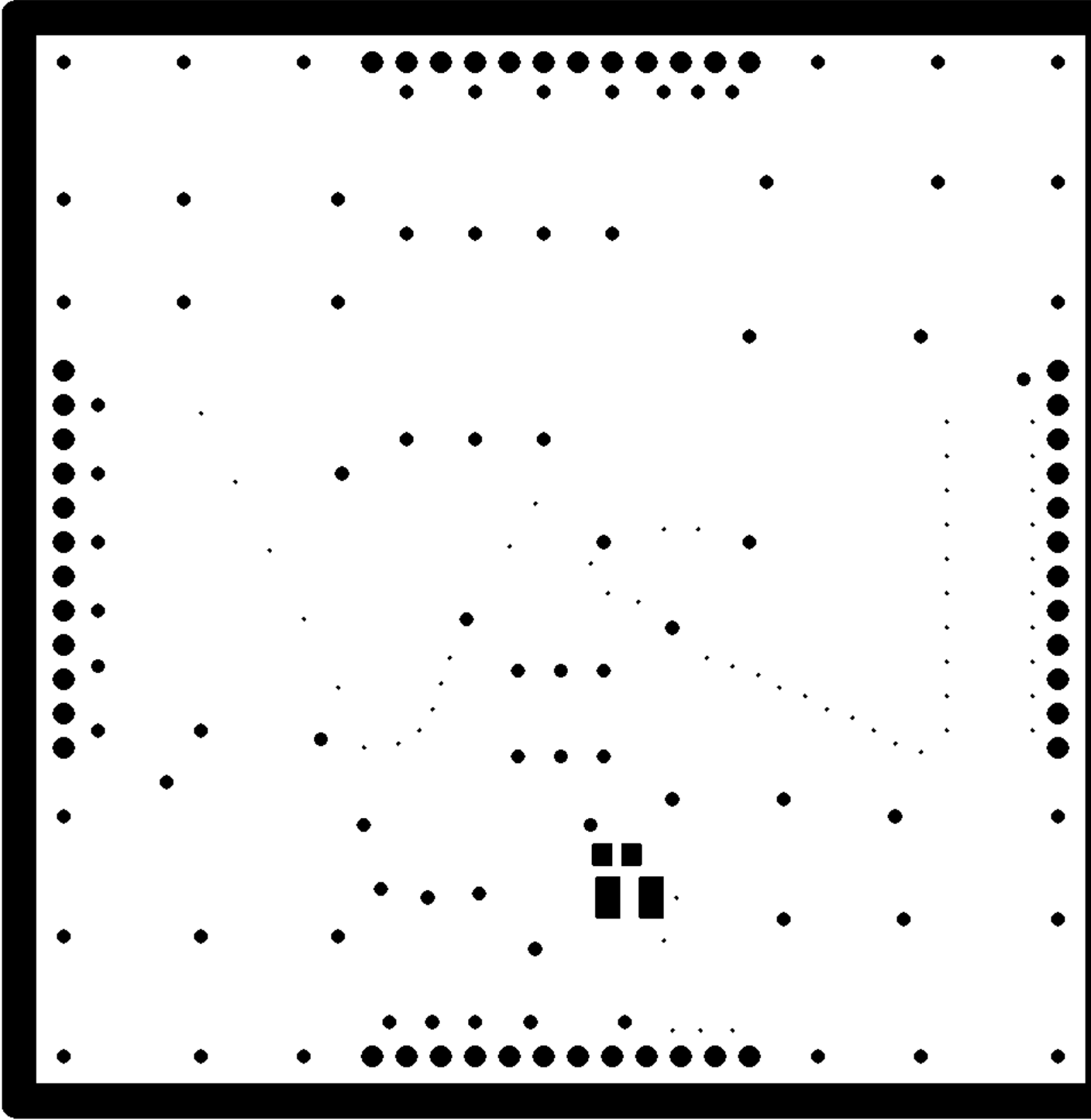

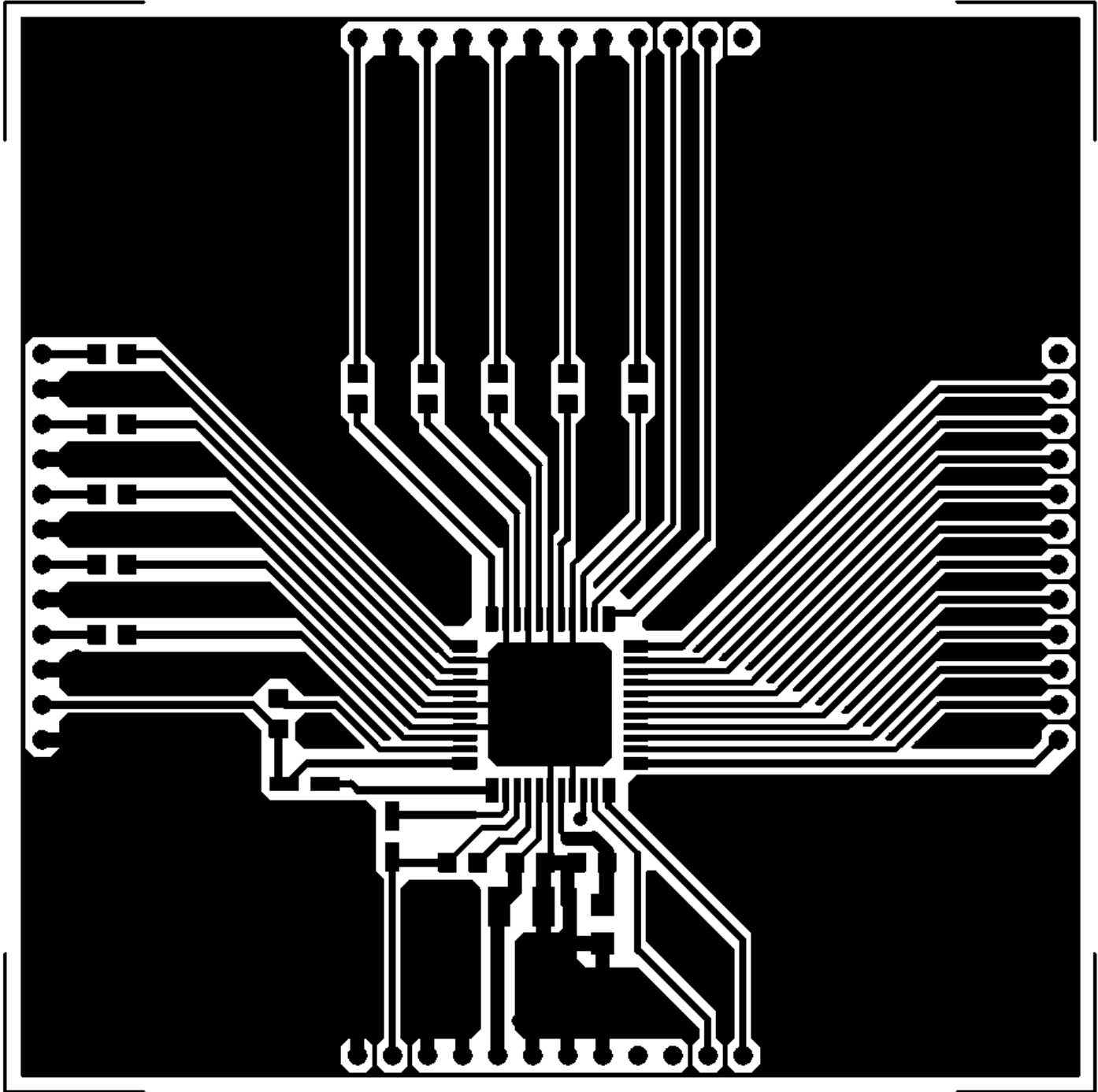

o n o n o n o n o n o o o o o

n o n o n o n o n o n o

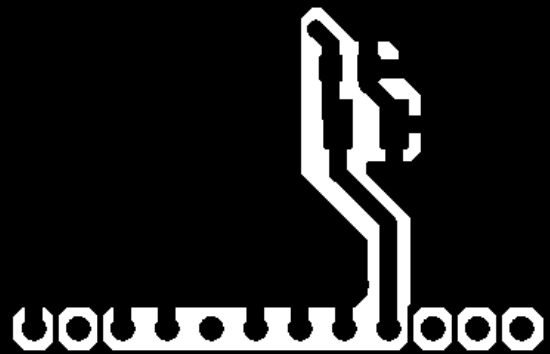

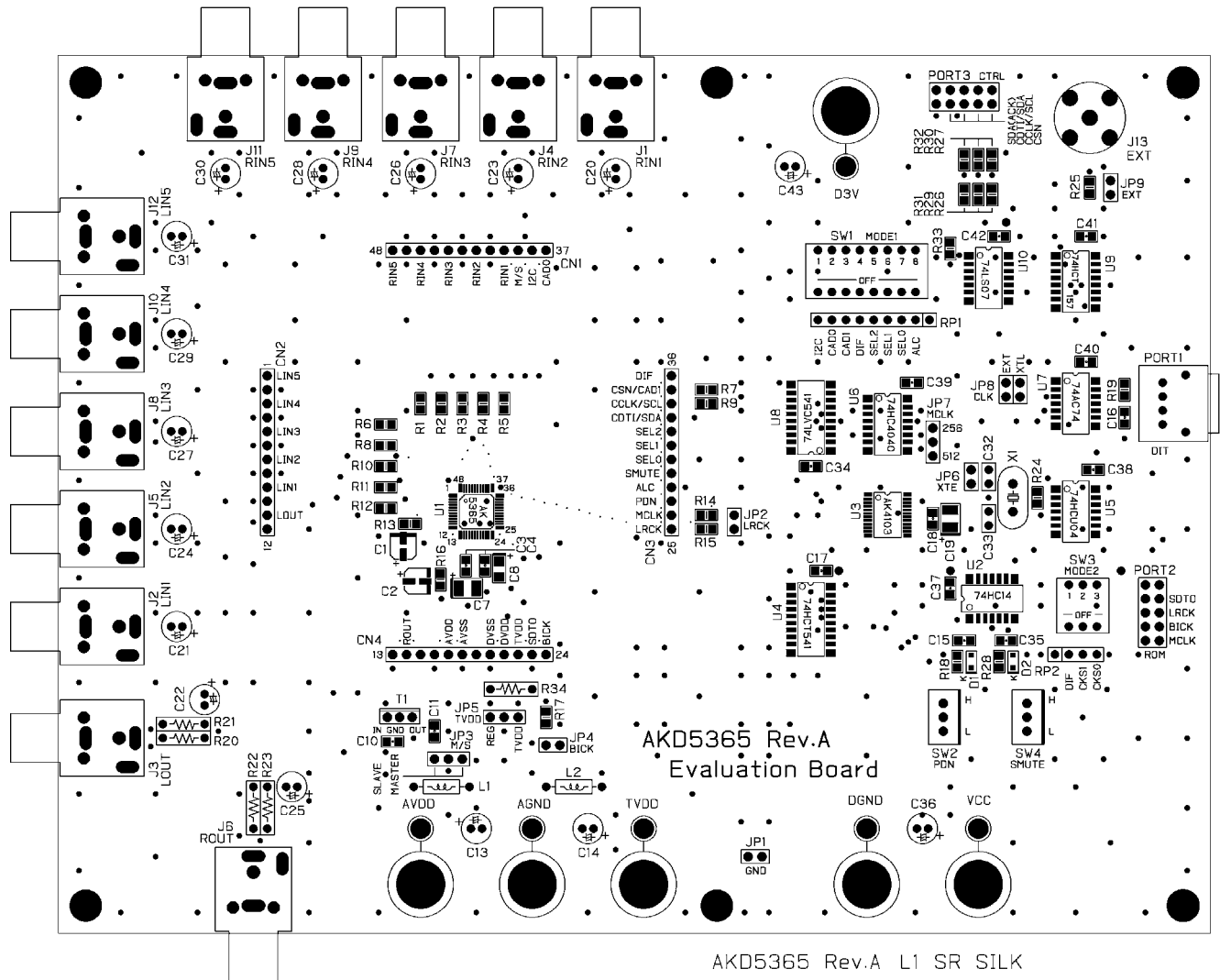

AKD5365 Rev.A  
Evaluation Board

AKD5365 Rev.A L1 SR SILK

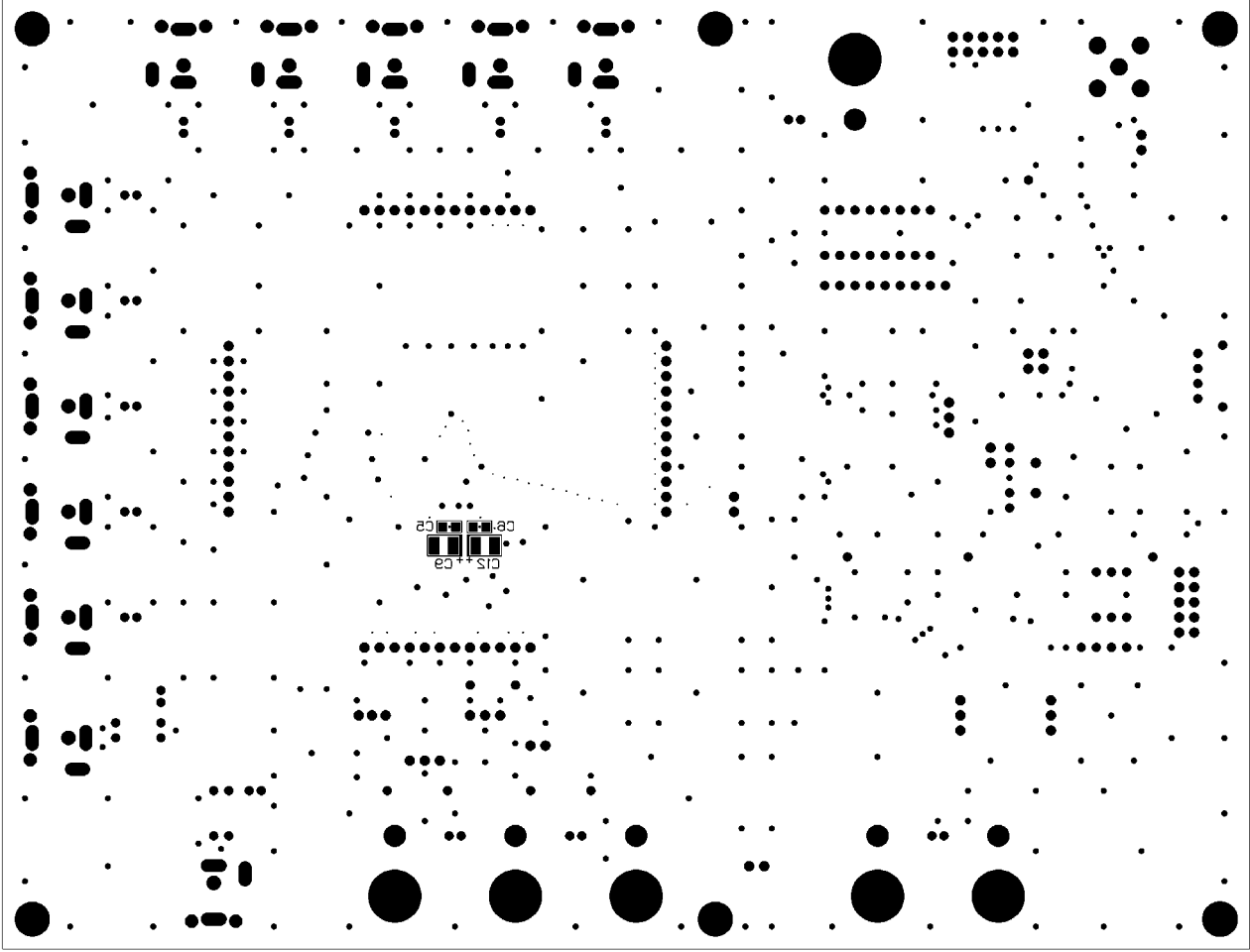

AKD5385 Rev.A LS SR SILK

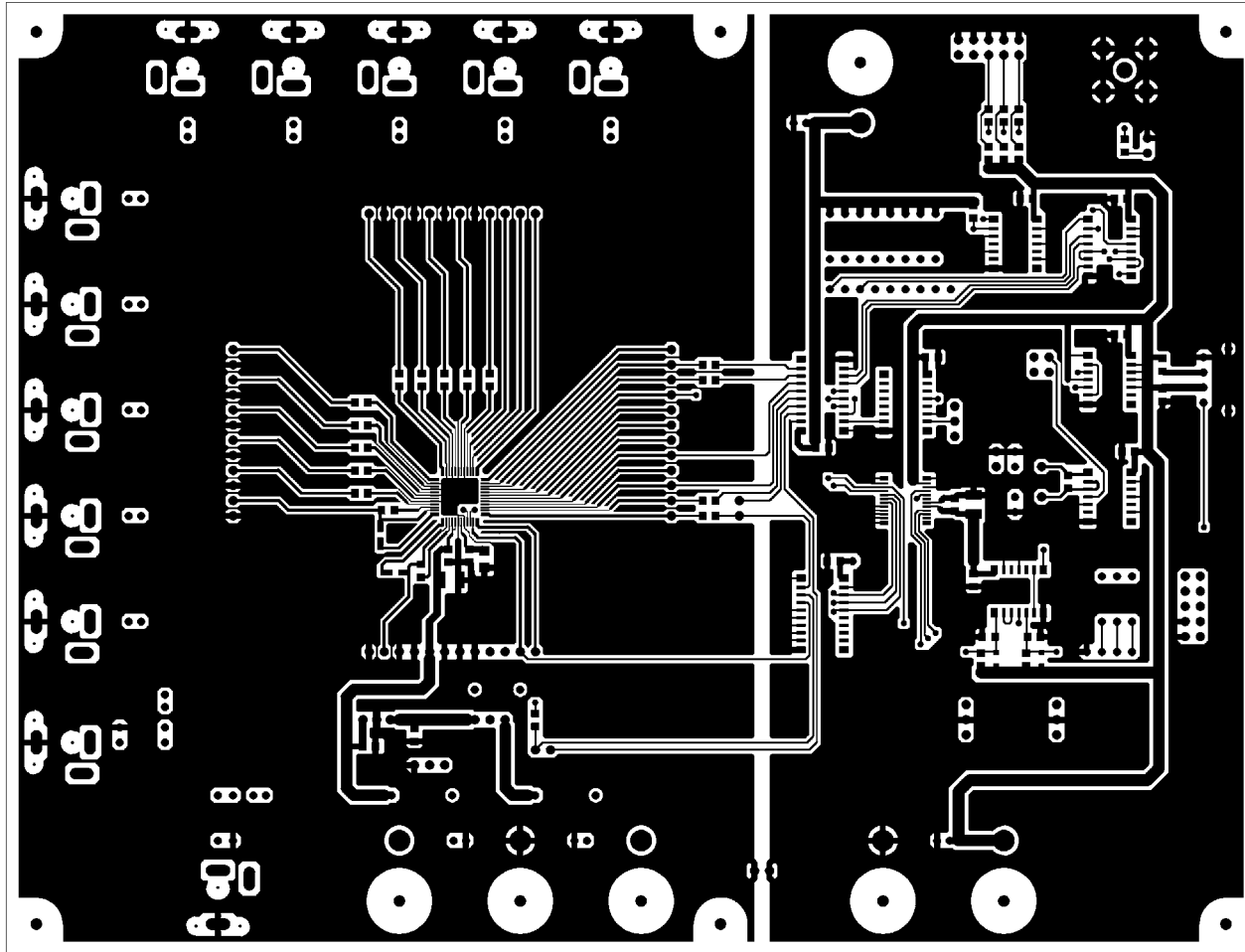

AKD5365 Rev.A L1

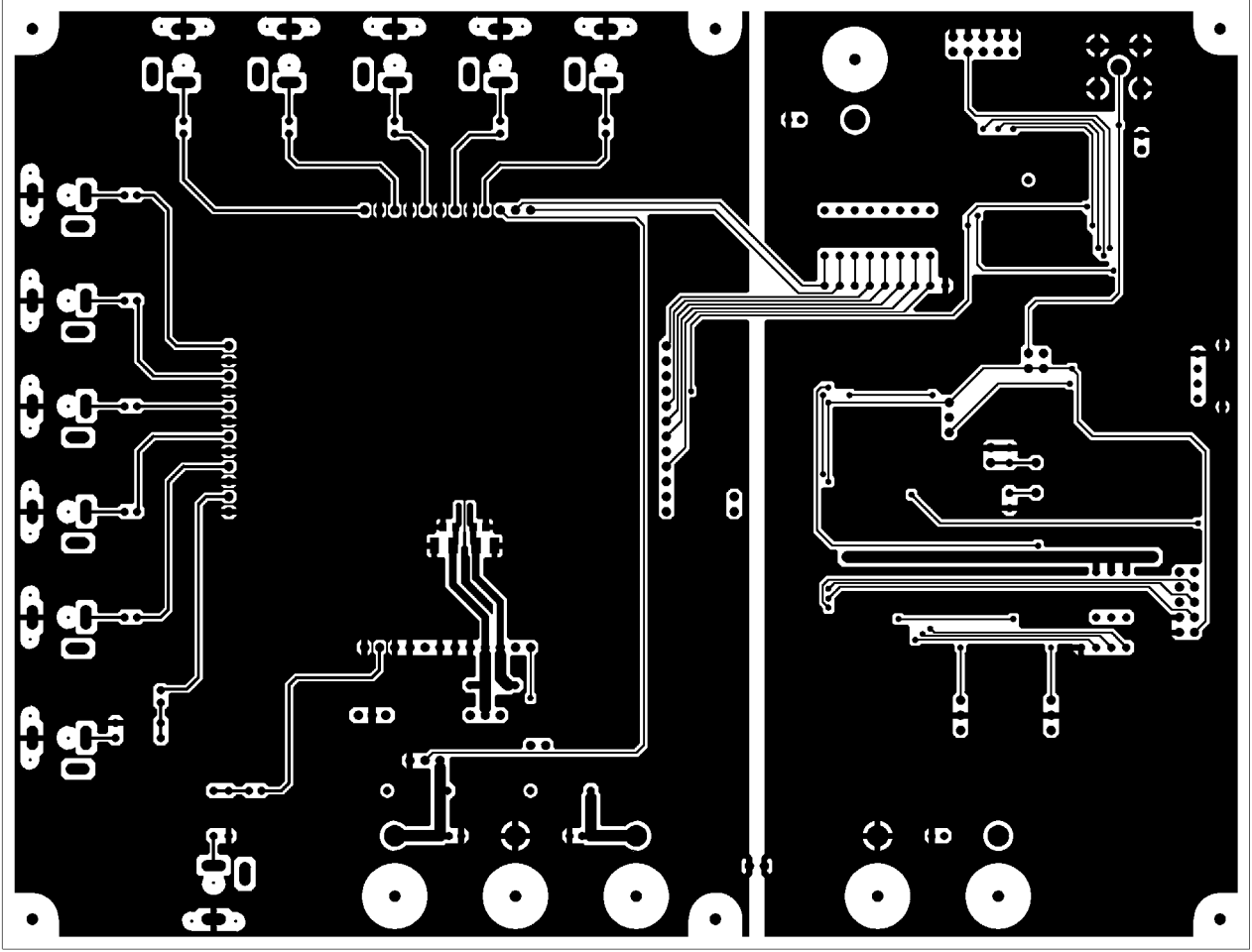

AKD2382 Rev.A LS