

FEATURES

- 1500VDC Isolation
- Six-Sided Shielding
- MTBF>700,000 Hours
- Remote On/Off Control
- UL1950 Safety Approval
- Internal SMT Construction
- 4:1 Ultra Wide Input Range
- UL 94V-0 Package Material
- Complies with EN55022 Class A
- **Call Factory for More Output Power Options**
- Chassis Mount Options: Open Frame, U Channel, and Enclosed Types Available

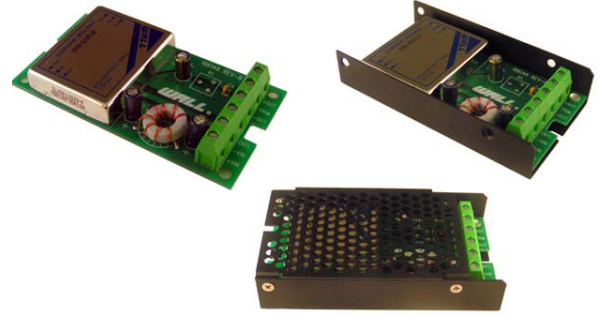

SPECIFICATIONS: CMDMW Series					
All specifications are based on 25°C, Nominal Input Voltage, and Maximum Output Current unless otherwise noted. We reserve the right to change specifications based on technological advances.					
SPECIFICATION	TEST CONDITIONS	Min	Nom	Max	Unit
INPUT (V_{in})					
Operating Voltage Range		9-36, 18-75			VDC
Start Voltage	24V input models	8	8.5	9	VDC
	48V input models	15	17	18	VDC
Under Voltage Shutdown	24V input models	7	8	8.5	VDC
	48V input models	13	15	17	VDC
Reverse Polarity Input Current				1	A
Short Circuit Input Power			3500		mW
Input Surge Voltage (1000ms)	24V input models	-0.7		50	VDC
	48V input models	-0.7		100	VDC
OUTPUT (V_o)					
Output Voltage Range		See Rating Chart			
Output Voltage Accuracy			±1.0	±2.0	%
Load Regulation	I _o = 10% to 100%		±0.5	±1.0	%
Line Regulation	V _{in} = min. to max.		±0.1	±0.5	%
Output Power				15	W
Output Current Range		See Rating Chart			
Ripple & Noise (peak to peak)	20MHz		55	80	mV _{pk-pk}
Ripple & Noise (peak to peak)	Over Line, Load, and Temperature			100	mV _{pk-pk}
Ripple & Noise				15	mVrms
Transient Recovery Time	25% load step change		300	500	µs
Transient Response Deviation	25% load step change		±2	±4	%
REMOTE ON/OFF					
Supply On		2.5 to 5.5VDC or Open Circuit			
Supply Off		-0.7		0.8	VDC
Standby Input Current				10	mA
Control Input Current (On)	V _{in} – RC = 5.0V			50	mA
Control Input Current (Off)	V _{in} – RC = 0V			-1	mA
Control Common		Referenced to negative input			
PROTECTION					
Over Power Protection		120			%
Short Circuit Protection		Continuous			
GENERAL					
Efficiency		See Rating Chart			
Switching Frequency		290	330	400	KHz
Isolation Voltage Rated	60 seconds	1500			VDC
Isolation Voltage Test	Flash Test for 1 second	1650			VDC
Isolation Resistance	500VDC	1000			MΩ
Isolation Capacitance	100KHz, 1V		1200	1500	pF
Internal Power Dissipation				5,000	mW
ENVIRONMENTAL					
Operating Temperature (Ambient)		-40		+60	°C
Operating Temperature (Case)		-40		+100	°C
Storage Temperature		-50		+125	°C
Lead Temperature	1.5mm from case for 10 seconds			260	°C
Humidity				95	%
Cooling		Free air convection			
RFI		Six-sided shielding, metal case			
Temperature Coefficient			±0.01	±0.02	%/°C
MTBF	MIL-HDBK-217F @ 25°C, Ground Benign	700			Hours
Conducted EMI		EN55022 Class A			
PHYSICAL					
Weight		Approximately 6oz			
Dimensions		4.00(L) x 2.25(W) x 0.81(H) inches			
Flammability		UL94V-0			
Heatsink material		Aluminum			
Heatsink finish		Anodic treatment (black)			

OUTPUT VOLTAGE / CURRENT RATING CHART

Model Number	Input Voltage	Output Voltage	Output Current		Input Current		Reflected Ripple Current	Efficiency (Typ)	Max Capacitive Load
			Min	Max	No Load	Max Load			
CMDMW24S3.3-3000	24 VDC (9 - 36 VDC)	3.3 VDC	300 mA	3000mA	25mA (typ)	528 mA	40mA (typ)	78%	470 μ F
CMDMW24S5-3000		5 VDC	300 mA	3000 mA		762 mA		82%	470 μ F
CMDMW24S5.1-3000		5.1 VDC	300 mA	3000 mA		735 mA		81%	470 μ F
CMDMW24S12-1250		12 VDC	125 mA	1250 mA		726 mA		85%	470 μ F
CMDMW24S15-1000		15 VDC	100 mA	1000 mA		771 mA		86%	470 μ F
CMDMW48S3.3-3000	48 VDC (18 - 75 VDC)	3.3 VDC	300 mA	3000 mA	15mA (typ)	26 mA	30mA (typ)	78%	470 μ F
CMDMW48S5-3000		5 VDC	300 mA	3000 mA		381 mA		82%	470 μ F
CMDMW48S5.1-3000		5.1 VDC	300 mA	3000 mA		368 mA		81%	470 μ F
CMDMW48S12-1250		12 VDC	125 mA	1250 mA		363 mA		85%	470 μ F
CMDMW48S15-1000		15 VDC	100 mA	1000 mA		386 mA		86%	470 μ F

NOTES

1. Transient recovery time is measured to within 1% error band for a step change in output load of 75% to 100%.
2. Ripple and noise measured at 20MHz bandwidth.
3. The CMDMW series requires a minimum 10% load on the output to maintain specified regulation. Operation under no-load condition will not damage these devices, however they may not meet all listed specifications.
4. Other input and output voltages may be available, please contact factory.
5. On/Off control is optional, please contact factory. Control voltage referenced to negative input (-Vin).
6. Heat-sink is optional, consult factory.
7. Chassis Mount Options: No suffix for open frame, "U" suffix for U Channel, and "E" suffix for Enclosed type.

BLOCK DIAGRAM

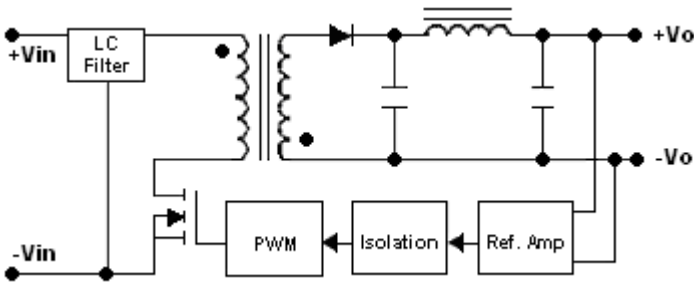

INPUT VOLTAGE TRANSIENT RATING

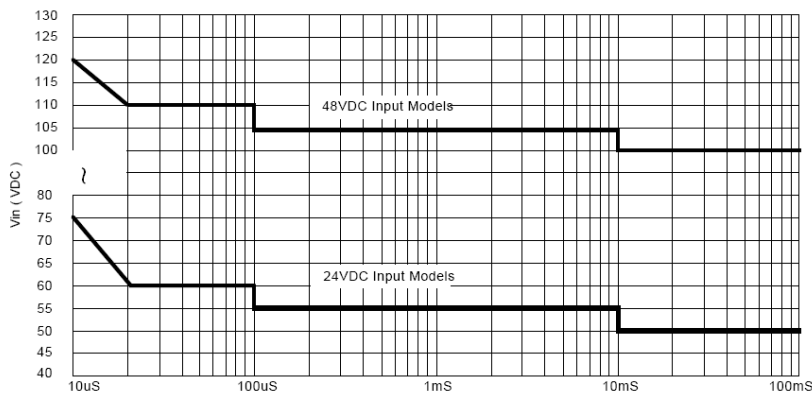

MECHANICAL DRAWING

Unit: inches [mm]

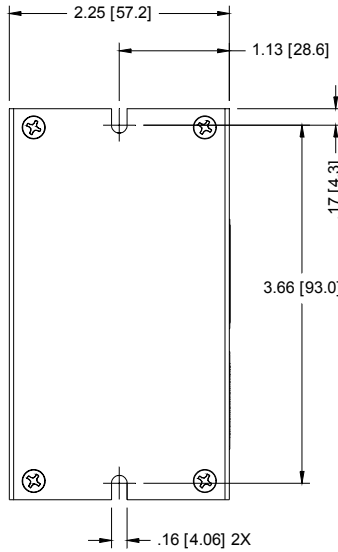
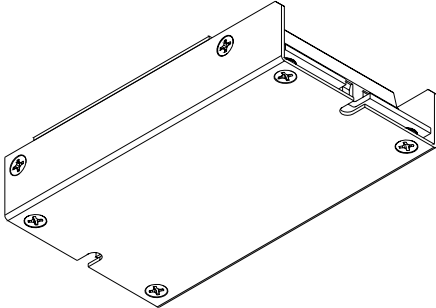
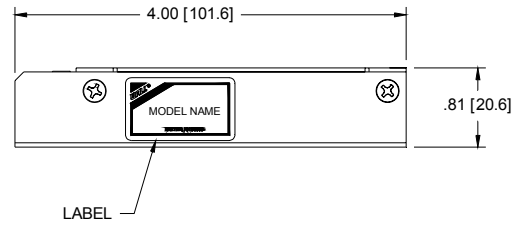
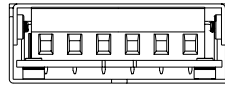
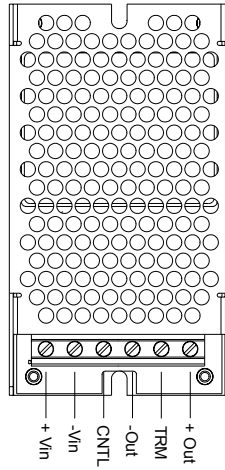
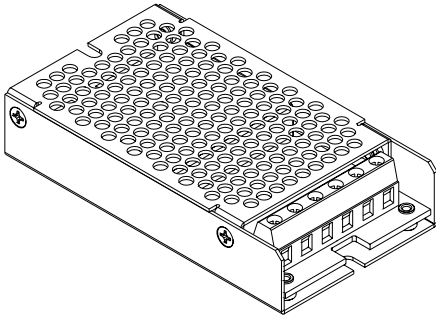

DESIGN & FEATURE CONSIDERATIONS

Remote On/Off

Positive logic remote on/off turns the module on during a logic high voltage on the remote on/off pin, and off during a logic low. To turn the power module on and off, the user must supply a switch to control the voltage between the on/off terminal and the -Vin terminal. The switch can be an open collector or equivalent.

A logic low is -0.7V to 0.8V.

A logic high is 2.5V to 5.5V.

The maximum sink current at on/off terminal during a logic low is -1mA. The maximum allowable leakage current of the switch at on/off terminal (2.5 to 5.5V) is 50uA.

Over Current Protection

To provide protection in a fault (output overload) condition, the unit is equipped with internal current limiting circuitry and can endure current limiting for an unlimited duration. At the point of current-limit inception, the unit shifts from voltage control to current control. The unit operates normally once the output current is brought back into its specified range.

Efficiency vs Input Voltage

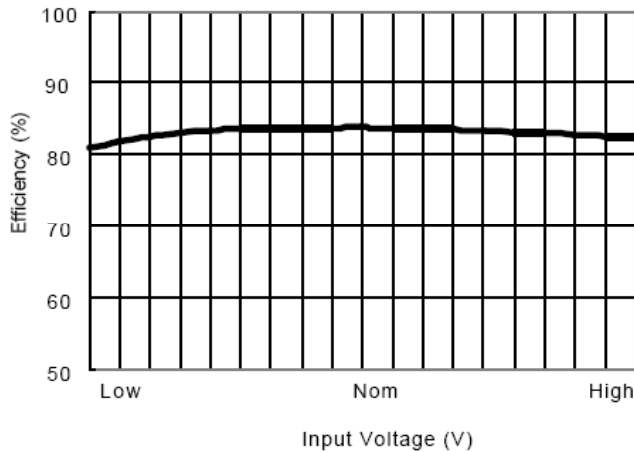

Efficiency vs Output Load

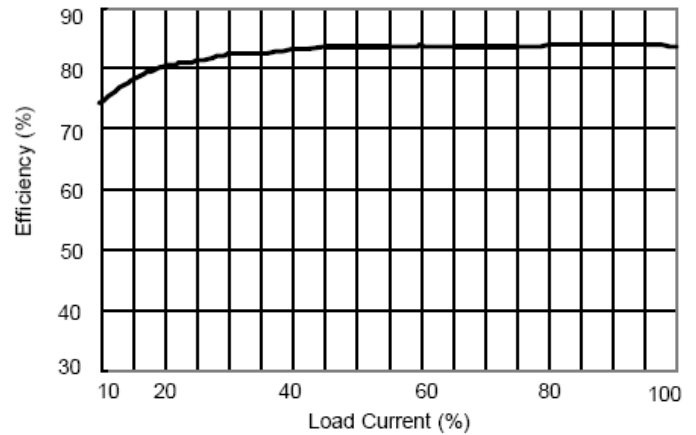

Derating Curve without Heatsink

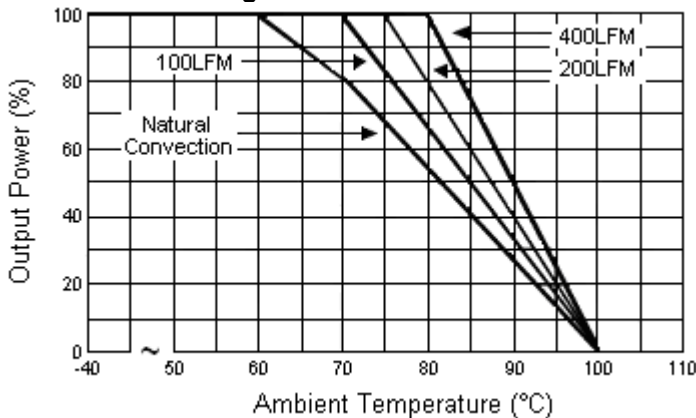

Derating Curve with Heatsink

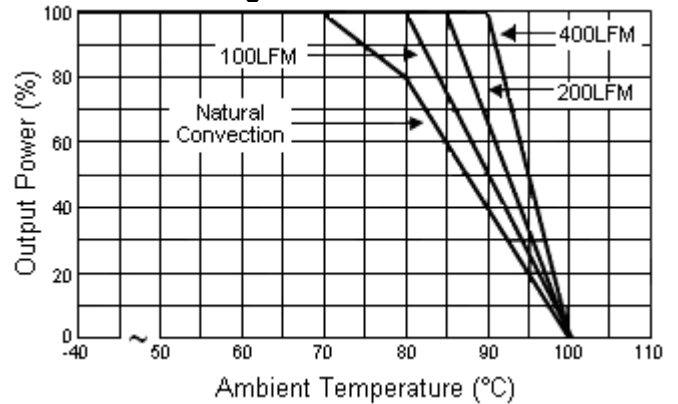

TEST CONFIGURATIONS

Input Reflected-Ripple Current Test Setup

Input reflected-ripple current is measured with an inductor L_{in} (4.7uH) and C_{in} (220uF, ESR < 1.0Ω at 100 KHz) to simulate source impedance.

Capacitor C_{in} offsets possible battery impedance.

Current ripple is measured at the input terminals of the module. Measurement bandwidth is 0-500 KHz.

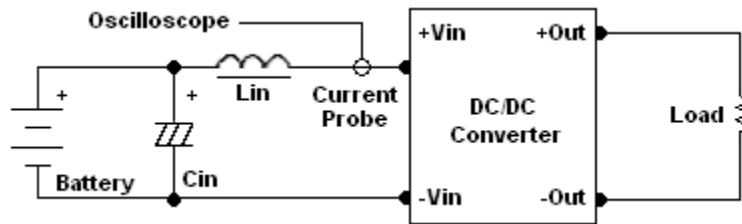

Peak-to-Peak Output Noise Measurement Test

Use a C_{out} 0.47uF ceramic capacitor.

Scope measurement should be made by using a BNC socket; measurement bandwidth is 0-20 MHz. Position the load between 50 mm and 75 mm from the DC/DC Converter.

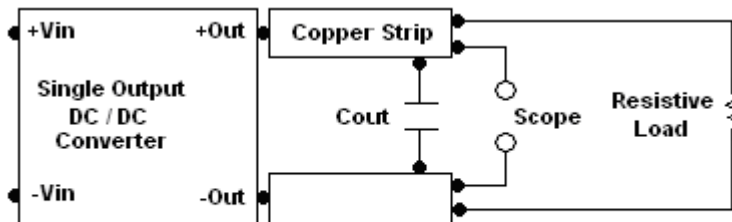

Thermal Considerations

Many conditions affect the thermal performance of the power module, such as orientation, airflow over the module, and board spacing. To avoid exceeding the maximum temperature rating of the components inside the power module, the case temperature must be kept below 100°C. The derating curves are determined from measurements obtained in an experimental apparatus.

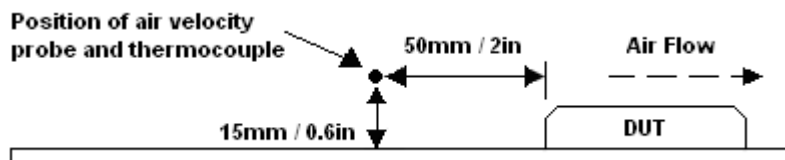



Wall Industries, Inc.

Rev. B

CMDMW Series
15 Watt Single Output
Chassis Mount DC/DC Converter
4:1 Ultra Wide Input Voltage Range

COMPANY INFORMATION:

Wall Industries, Inc. has created custom and modified units for over 40 years. Our in-house research and development engineers will provide a solution that exceeds your performance requirements on time and on budget. Our ISO9001-2000 certification is just one example of our commitment to producing a high quality, well documented product for our customers.

Our past projects demonstrate our commitment to you, our customer. Wall Industries, Inc. has a reputation for working closely with its customers to ensure each solution meets or exceeds form, fit and function requirements. We will continue to provide ongoing support for your project above and beyond the design and production phases. Give us a call today to discuss your future projects.

Contact **Wall Industries** for further information:

<u>Phone:</u>	☎(603)778-2300
<u>Toll Free:</u>	☎(888)587-9255
<u>Fax:</u>	☎(603)778-9797
<u>E-mail:</u>	sales@wallindustries.com
<u>Web:</u>	www.wallindustries.com
<u>Address:</u>	5 Watson Brook Rd. Exeter, NH 03833