

● **Features :**

1. Compact dual-in-line Package.
2. 600V peak blocking voltage.
3. Isolation voltage between input and output 2500Vrms.

● **Application :**

1. TRIAC Driver.
2. Programmable Controllers.
3. AC-Output Module.
4. Solid State Relay.

● **Outside Dimension : Unit (mm)**

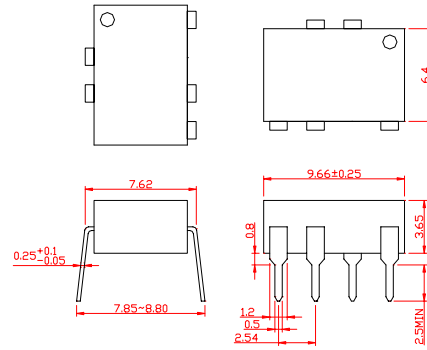

● **Schematic : Top View**

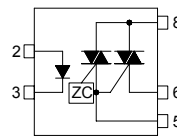

- 2 : Anode
- 3 : Cathode
- 5 : TRIAC Gate
- 6 : TRIAC T1
- 8 : TRIAC T2

● **Absolute Maximum Ratings : (Ta=25°C)**

CHARACTERISTIC		SYMBOL	RATING	UNIT
Input	Forward Current	I_F	50	mA
	Forward Current Derating ($T_a \geq 53^\circ\text{C}$)	$\Delta I_F/^\circ\text{C}$	-0.7	mA/°C
	Peak Forward Current (100 μs pulse, 100pps)	I_{FP}	1	A
	Reverse Voltage	V_R	5	V
	Junction Temperature	T_j	125	°C
Output	Off-State Output Terminal Voltage	V_{DRM}	600	V
	On-State RMS Current	$T_a=40^\circ\text{C}$	0.5	A
		$T_a=60^\circ\text{C}$	0.35	
	On-State Current Derating ($T_a \geq 40^\circ\text{C}$)	$\Delta I_T/^\circ\text{C}$	-7.2	mA/°C
	Peak Current from Snubber Circuit (100 μs pulse, 120pps)	I_{SP}	2	A
	Peak Nonrepetitive Surge Current (50Hz, Peak)	I_{TSM}	5	A
Junction Temperature	T_j	110	°C	
Storage Temperature Range		T_{stg}	-40~125	°C
Operating Temperature Range		T_{opr}	-20~80	°C
Lead Soldering Temperature (10s)		T_{sol}	260	°C
Isolation Voltage (AC, 1min., R.H. \leq 60%)		BV_S	2500	Vrms

● **Electro-optical characteristics :**

CHARACTERISTIC	SYMBOL	TEST CONDITION	MIN.	TYP.	MAX.	UNIT	
Input	Forward Voltage	V_F	$I_F=10\text{mA}$	1.0	1.15	1.3	V
	Reverse Current	I_R	$V_R=5\text{V}$	-	-	10	μA
	Capacitance	C_T	$V=0, f=1\text{MHz}$	-	30	-	pF
Output	Peak Off-State Current	I_{DRM}	$V_{DRM}=600\text{V}, T_a=110^\circ\text{C}$	-	-	100	μA
	Peak On-State Voltage	V_{TM}	$I_{TM}=0.75\text{A}$	-	-	3.0	V
	Holding Current	I_H	$R_L=100\Omega$	-	-	25	mA
	Critical Rate of Rise of Off-State Voltage	dv/dt	$V_{in}=240\text{Vrms}$	-	500	-	V/ μs
	Critical Rate of Rise of Commutating Voltage	dv/dt(c)	$V_{in}=240\text{Vrms}, I_T=0.5\text{Arms}$	-	5	-	V/ μs
Transfer	Trigger LED Current	I_{FT}	$V_T=6\text{V}$	-	-	10	mA
	Inhibit Voltage	V_{INH}	$I_F=\text{Rated } I_{FT}$	-	-	50	V
	Leakage in Inhibited State	I_{DRM2}	$I_F=\text{Rated } I_{FT}, V_T=\text{Rated } V_{DRM}$	-	200	-	μA
	Capacitance (Input to Output)	C_S	$V_S=0, f=1\text{MHz}$	-	1.5	-	pF
	Isolation Resistance	R_S	$V_S=500\text{V}$	5×10^{10}	10^{14}	-	Ω
			AC, 1minute	2500	-	-	Vrms
AC, 1second, in oil			-	5000	-		
Isolation Voltage	BV_S	DC, 1minute, in oil	-	5000	-	Vdc	