

max. 133 m<sup>3</sup>/h

# DC axial fans

Series 3300 N 92 x 92 x 32 mm



- **Material:** Housing: GRP<sup>1)</sup> (PBT)  
Impeller: GRP<sup>1)</sup> (PA)
  - **Direction of air flow:** Exhaust over struts
  - **Direction of rotation:** Clockwise, seen on rotor
  - **Connection:** Via single wires AWG 24  
UL 1061, TR 64
  - **Mass:** 190 g
- **Possible special versions:**  
(See chapter DC fans - specials)
    - Speed signal
    - Go / No-go alarm
    - External temperature sensor
    - Internal temperature sensor
    - PWM control input
    - Analogue control input
    - Protection against moisture
    - Protection against salt fog
    - Type of protection: IP 54 / IP 68

1) Fibreglass-reinforced plastic

Nominal data		Air flow	Air flow	Nominal voltage	Voltage range	Sound pressure level	Sound power level	Sintec sleeve bearings Ball bearings	Input power	Nominal speed	Temperature range	Service life L <sub>10</sub> (40 °C) ebm-papst Standard	Service life L <sub>10</sub> (T <sub>max</sub> ) ebm-papst Standard	Life expectancy L <sub>10</sub> (IPC (40 °C) see page 17	Curve
Type		m <sup>3</sup> /h	CFM	VDC	VDC	dB(A)	Bel(A)	■ / ■	Watts	rpm	°C	Hours	Hours		
NEW	3312 NL	56	33	12	6...15	24	4,1	■	0,8	1 850	-20...+75	80 000 / 35 000	135 000	①	
NEW	3312 NM	68	40	12	6...15	29	4,5	■	1,3	2 250	-20...+75	70 000 / 30 000	117 500	②	
NEW	3312 NN	80	47	12	6...15	35	4,7	■	1,8	2 650	-20...+75	70 000 / 30 000	117 500	③	
NEW	3312 NH	93	54	12	6...15	38	5,1	■	2,8	3 050	-20...+75	65 000 / 27 500	110 000	④	
NEW	3312 NHH	107	63	12	6...15	42	5,4	■	3,4	3 450	-20...+75	57 500 / 25 000	97 500	⑤	
NEW	3312 NH3	133	78	12	6...14	50	6,0	■	6,7	4 350	-20...+70	50 000 / 25 000	85 000	⑥	
NEW	3314 NN	80	47	24	18...28	35	4,7	■	1,8	2 650	-20...+75	70 000 / 30 000	117 500	③	
NEW	3314 NH	93	54	24	18...28	38	5,1	■	2,6	3 050	-20...+75	65 000 / 27 500	110 000	④	
NEW	3314 NHH	107	63	24	18...28	42	5,4	■	3,5	3 450	-20...+75	57 500 / 25 000	97 500	⑤	
NEW	3314 NH3	133	78	24	18...28	50	6,0	■	6,7	4 350	-20...+75	50 000 / 22 500	85 000	⑥	
NEW	3318 NN	80	47	48	36...60	35	4,7	■	1,8	2 650	-20...+75	70 000 / 30 000	117 500	③	
NEW	3318 NH	93	54	48	36...60	38	5,1	■	3,5	3 050	-20...+75	65 000 / 27 500	110 000	④	
NEW	3318 NH3	133	78	48	36...58	50	6,0	■	6,5	4 350	-20...+75	50 000 / 22 500	85 000	⑥	

Subject to alternations

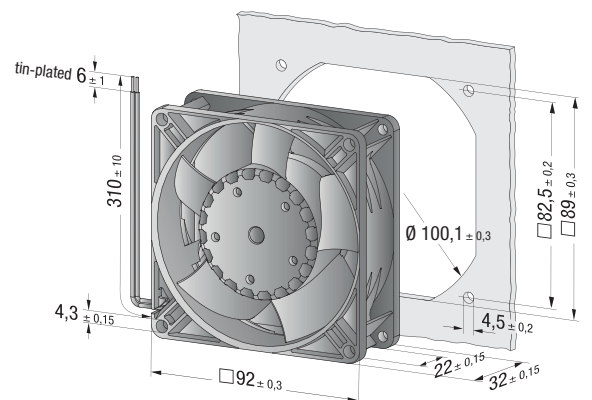
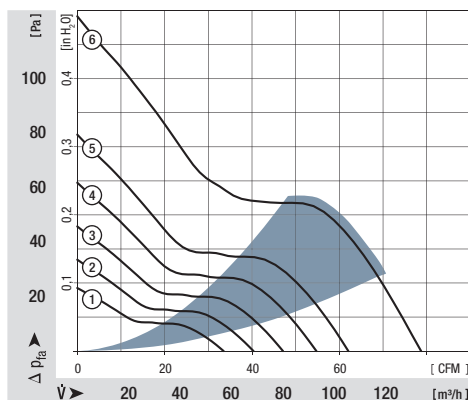

# Speed signal /2

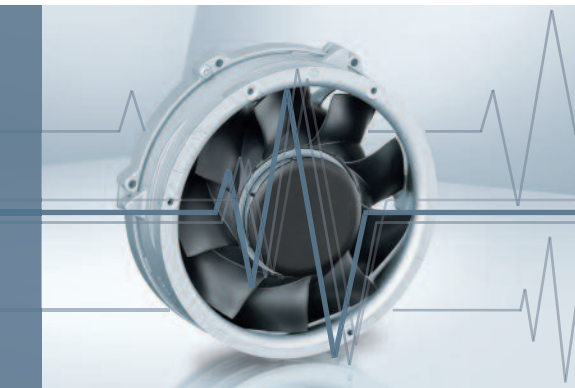

- Speed-proportional, square-wave signal for external monitoring of the fan motor speed
- 2, 3, or 6 pulses per revolution
- Open-collector signal output
- Extremely wide operating voltage range
- Easy adaptation to user interface
- Connection via separate cable
- The sensor signal also serves as a major comparison variable for setting and maintaining the setpoint speed for interactive or controlled cooling with one or more interconnected fans.

## Electrical hookup

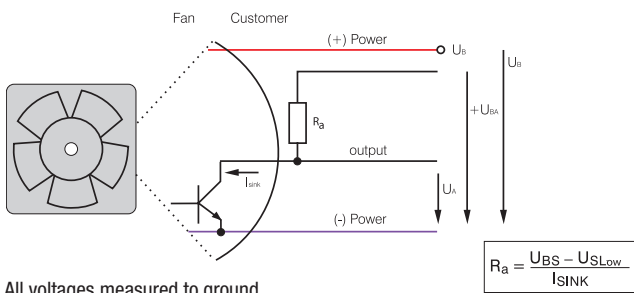

All voltages measured to ground.  
External load resistor  $R_a$  /  $U_S$  /  $U_{BS}$  required.

## Signal output voltage

Standard signal for all models (exceptions see below)

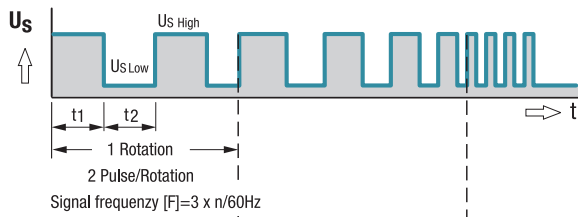

For multi options control input and 4100 NH7 and NH8

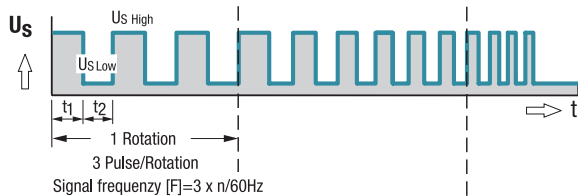

All TD Fans e.g. 6300 TD

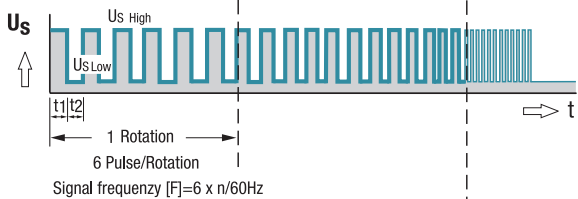

## Fan speed

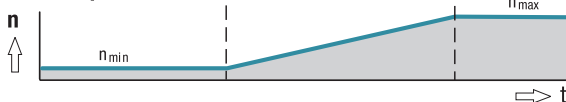

Signal data	Speed signal	Condition:	Speed signal	Condition:	Tach operating	Admissible sink current	Pulses per revolution	Fan description
	$U_{S\ Low}$	$I_{SINK}$	$U_{S\ High}$	$I_{SOURCE}$	voltage $U_{BS\ max.}$	$I_{SINK\ max.}$		Basic type
Type	VDC	mA	VDC	mA	VDC	mA	Page	
250	≤ 0.4	2	≤ 30	0	30	2	2	31
400 F	≤ 0.4	1	≤ 30	0	30	2	2	32
400	≤ 0.4	1	≤ 30	0	30	2	2	33
420 J	≤ 0.4	2	≤ 15	0	15	4	2	34
500 F	≤ 0.4	1	≤ 30	0	30	2	2	35
600 F	≤ 0.4	1	≤ 30	0	30	2	2	36
620	≤ 0.4	2	≤ 30	0	30	4	2	37
630 U	≤ 0.4	2	≤ 30	0	30	4	2	38
600 N	≤ 0.4	2	≤ 28	0	28	4	2	39
600 J	≤ 0.4	2	≤ 30	0	30	4	2	41
700 F	≤ 0.4	2	≤ 30	0	30	4	2	42
8450	≤ 0.4	2	≤ 28	0	28	4	2	43
8400 N	≤ 0.4	2	≤ 28	0	28	4	2	44
8400 N VARIOFAN	≤ 0.4	2	≤ 30	0	30	4	2	45
8300	≤ 0.4	2	≤ 30	0	30	4	2	46
8200 J	≤ 0.4	2	≤ 30	0	30	4	2	47
3400 N	≤ 0.4	2	≤ 28	0	28	4	2	48
3400 N VARIOFAN	≤ 0.4	2	≤ 30	0	30	4	2	49
3300 N	≤ 0.4	2	≤ 30	0	30	4	2	50
3212 J / 3214 J	≤ 0.4	2	≤ 30	0	30	4	2	51
3218 J	≤ 0.4	2	≤ 60	0	60	4	2	51
3250 J	≤ 0.4	2	≤ 60	0	60	4	3	52
4412 F / 4414 F	≤ 0.4	2	≤ 30	0	30	4	2	53
4418 F	≤ 0.4	2	≤ 60	0	60	4	2	53
4400 FN	≤ 0.4	2	≤ 30	0	30	4	2	55
4312 / 4314	≤ 0.4	2	≤ 30	0	30	4	2	56
4318	≤ 0.4	2	≤ 60	0	60	4	2	56
4312 / 4314 VARIOFAN	≤ 0.4	2	≤ 30	0	30	4	2	57
4318 VARIOFAN	≤ 0.4	2	≤ 60	0	60	4	2	57
4400	≤ 0.4	2	≤ 30	0	30	4	2	58/59
4100 N	≤ 0.4	2	≤ 30	0	30	4	2	60
4100 NHH...NH6	≤ 0.4	2	≤ 60	0	60	10	2	61
4100 NH7...NH8	≤ 0.4	2	≤ 60	0	60	20	3	62
DV 4100	≤ 0.4	2	≤ 30	0	30	4	2	63
5200 N	≤ 0.4	2	≤ 30	0	30	4	2	64
DV 5200	≤ 0.4	2	≤ 30	0	30	4	2	65

Subject to change

**Available on request:**

- Electrically isolated speed signal circuit
- Varying voltage potentials for power and logic circuit

Signal data	Speed signal $U_{S\text{ Low}}$	Condition: $I_{\text{sink}}$	Speed signal $U_{S\text{ High}}$	Condition: $I_{\text{source}}$	Tach operating voltage $U_{BS\text{ max}}$	Admissible sink current $I_{\text{sink max}}$	Pulses per revolution	Fan description Basic type
Type	VDC	mA	VDC	mA	VDC	mA		Page
5112 N	≤ 0.4	2	≤ 15	0	5	20	2	66
5114 N / 5118 N	≤ 0.4	2	≤ 60	0	60	20	2	66
5300	≤ 0.4	2	≤ 60	0	60	4	2	67
5300 TD	≤ 0.4	2	≤ 60	0	60	20	6	68
7112 N / 7118 N	≤ 0.4	2	≤ 60	0	60	20	2	69
7114 N	≤ 0.4	2	≤ 30	0	30	20	2	69
7200 N	≤ 0.4	2	≤ 15	0	15	20	2	70
6400	≤ 0.4	2	≤ 60	0	60	20	2	71
6300 TD	≤ 0.4	2	≤ 60	0	60	20	6	75
6300 N	≤ 0.4	2	≤ 60	0	60	20	6	76
6300 NTD	≤ 0.4	2	≤ 60	0	60	20	6	77
6300	≤ 0.4	2	≤ 60	0	60	20	2	78
DV 6300 TD	≤ 0.4	2	≤ 60	0	60	20	6	80
2200 FTD	≤ 0.4	2	≤ 60	0	60	20	6	81
RL 48	≤ 0.4	2	≤ 30	0	30	4	2	97
RL 65	≤ 0.4	2	≤ 30	0	30	4	2	98
RL 90 N	≤ 0.4	2	≤ 30	0	30	4	2	99
RLF 100	≤ 0.4	2	≤ 30	0	30	4	2	100
RG 90 N	≤ 0.4	2	≤ 30	0	30	4	2	101
RG 125 N	≤ 0.4	2	≤ 30	0	30	4	2	102
RG 140 N	≤ 0.4	3	≤ 60	0	60	4	2	103
RG 160 N	≤ 0.4	2	≤ 30	0	30	20	2	104
RG 160 NTD	≤ 0.4	2	≤ 60	0	60	20	6	105
RG 190 TD	≤ 0.4	2	≤ 60	0	60	20	6	106
RG 220 TD	≤ 0.4	2	≤ 60	0	60	20	6	107
RG 225 TD	≤ 0.4	2	≤ 60	0	60	20	6	108
RET 97 TD	≤ 0.4	2	≤ 60	0	60	20	6	109
REF 100	≤ 0.4	2	≤ 30	0	30	4	2	110
RER 120 TD	≤ 0.4	2	≤ 60	0	60	20	6	112
RER 133 TD	≤ 0.4	2	≤ 60	0	60	20	6	117
RER 160 NTD	≤ 0.4	2	≤ 60	0	60	20	6	119
REF 175 TD	≤ 0.4	2	≤ 60	0	60	20	6	120
RER 175 TD	≤ 0.4	2	≤ 60	0	60	20	6	121
RER 190 TD	≤ 0.4	2	≤ 60	0	60	20	6	122
RER 220 TD	≤ 0.4	2	≤ 60	0	60	20	6	128
RER 225 TD	≤ 0.4	2	≤ 60	0	60	20	6	129

Subject to change

**Note:**

Fans that come with these fan specials could have variations with respect to the temperature range, voltage range, and power consumption compared to standard fans without specials.