

RoHS  **HF 468 Series Fuse**

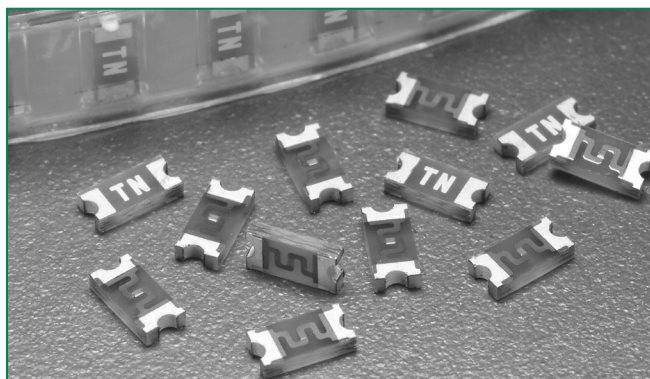

Description

The 468 Series Time-Lag (Slo-Blo®) SMF is a small (1206 size) thin-film device designed for secondary protection of circuits used in space constrained applications such as hand-held portable electronic devices.

This series is 100% lead-free and meets the requirements of the RoHS directive. New Halogen-Free 468 Series fuses are available—to order use the “HF” suffix. See Part Numbering section for additional information.

Features



- Complies with electronic industry environmental standards for lead reduction.
- Product is compatible with lead-free solders and higher temperature profiles.
- Time delay feature withstands high inrush currents and prevents nuisance openings.
- Package is visually distinct from fast-acting version for easy identification.
- Top side marking allows visual verification of amperage rating.

Applications

Secondary protection for space constrained applications:

- Cell phones
- Battery packs
- Digital cameras
- DVD players
- Hard disk drives.



Agency Approvals

AGENCY	AGENCY FILE NUMBER	AMPERE RANGE
	E10480	500MA - 3A
	LR29862	500MA - 3A

Electrical Characteristics for Series

% of Ampere Rating	Opening Time at 25°C
100%	4 hours, Minimum
200%	1 sec., Min.; 120 sec., Max.
300%	0.05 sec., Min.; 1.5 sec., Max
800%	0.0015 sec., Min.; .05 sec., Max.

Electrical Specifications by Item

Ampere Rating (A)	Amp Code	Max Voltage Rating (V)	Interrupting Rating	Nominal Cold Resistance (Ohms)	Nominal Melting I ² t (A ² sec)	Nom Voltage Drop (mV)	Nom Power Dissipation (W)	Agency Approvals	
									
0.50	.500	63	50 amperes @63 VAC/VDC	0.27000	0.0310	156.77	0.0784	x	x
1.00	001.	63		0.08250	0.1270	94.70	0.0947	x	x
1.50	01.5	63		0.04750	0.2880	82.32	0.1235	x	x
2.00	002.	63	35 amperes @63 VAC 50 amperes @63 VDC	0.03240	0.5060	77.27	0.1545	x	x
2.50	02.5	63		0.02240	1.0110	73.92	0.1848	x	x
3.00	003.	32	50 amperes @32 VAC/VDC	0.01950	1.2700	72.95	0.2189	x	x

1. Measured at 10% of rated current, 25°C.
 2. Measured at rated voltage.

468 Series

Temperature Derating Curve

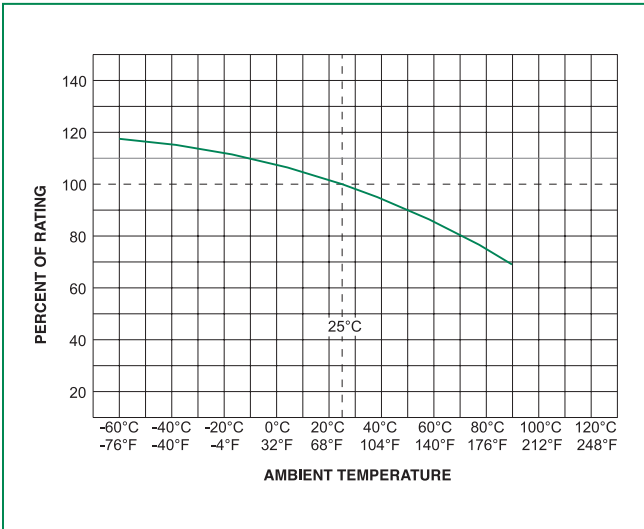

Note:

- Derating depicted in this curve is in addition to the standard derating of 25% for continuous operation.

Example:

For continuous operation at 70 degrees celsius, the fuse should be derated as follows:

$$I = (0.75)(0.80)I_{RAT} = (0.60)I_{RAT}$$

- The temperature derating curve represents the nominal conditions. For questions about temperature derating curve, please consult Littelfuse technical support for assistance.

Average Time Current Curves

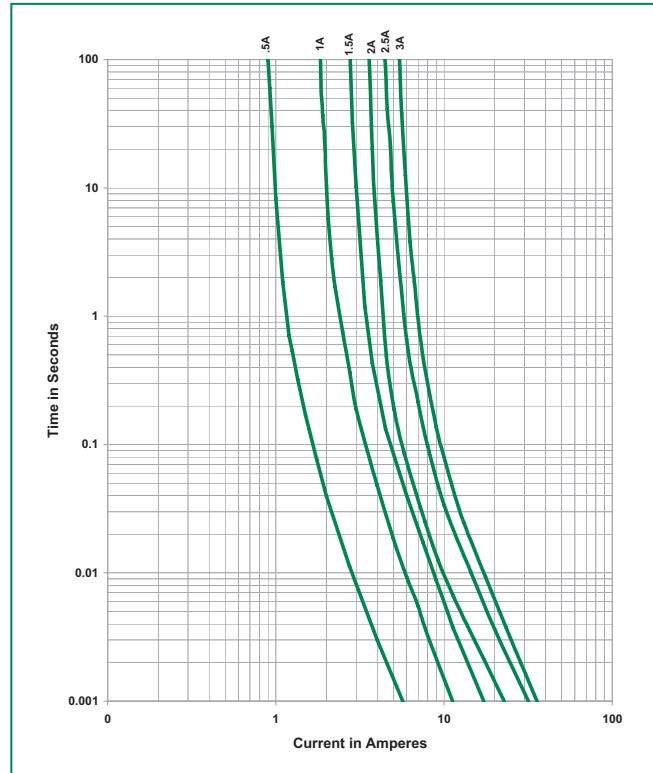

Soldering Parameters

Reflow Condition		Pb – Free assembly
Pre Heat	- Temperature Min ($T_{s(min)}$)	150°C
	- Temperature Max ($T_{s(max)}$)	200°C
	- Time (Min to Max) (t_s)	60 – 180 secs
Average ramp up rate (Liquidus Temp (T_L) to peak)		5°C/second max
$T_{s(max)}$ to T_L - Ramp-up Rate		5°C/second max
Reflow	- Temperature (T_L) (Liquidus)	217°C
	- Temperature (t_L)	60 – 150 seconds
Peak Temperature (T_p)		250 ^{+0/-5} °C
Time within 5°C of actual peak Temperature (t_p)		20 – 40 seconds
Ramp-down Rate		5°C/second max
Time 25°C to peak Temperature (T_p)		8 minutes Max.
Do not exceed		260°C

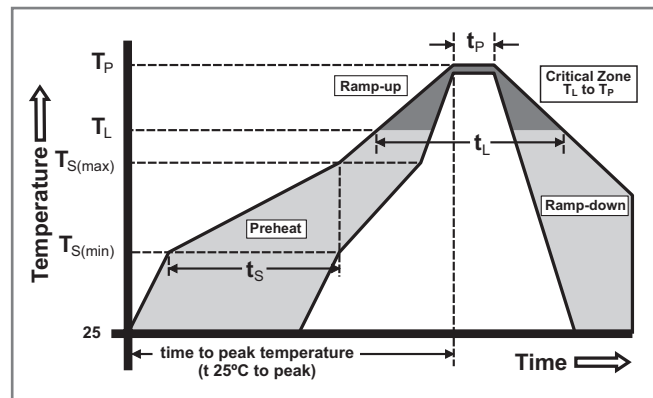

Wave Soldering	260°C, 10 seconds max.
----------------	------------------------

Product Characteristics

Materials	Body: Epoxy Substrate Terminations: 100% Tin over Nickel over Copper Element Cover Coat: Conformal Coating
Operating Temperature	-55°C to 90°C. Consult temperature derating curve chart. For operation above 90°C please contact Littelfuse
Thermal Shock	Withstands 5 cycles of - 50°C to 125°C
Humidity	MIL-STD-202F, Method 103B, Condition D

Vibration	Withstands 10-55 Hz per MIL-STD-202F, Method 201A and 10-2000 Hz at 20 G's per MIL-STD-202F, Method 204D, Condition D
Insulation Resistance (After Opening)	Greater than 10,000 ohms.
Resistance to Soldering Heat	MIL-STD-202G, Method 210F, Condition D

Dimensions

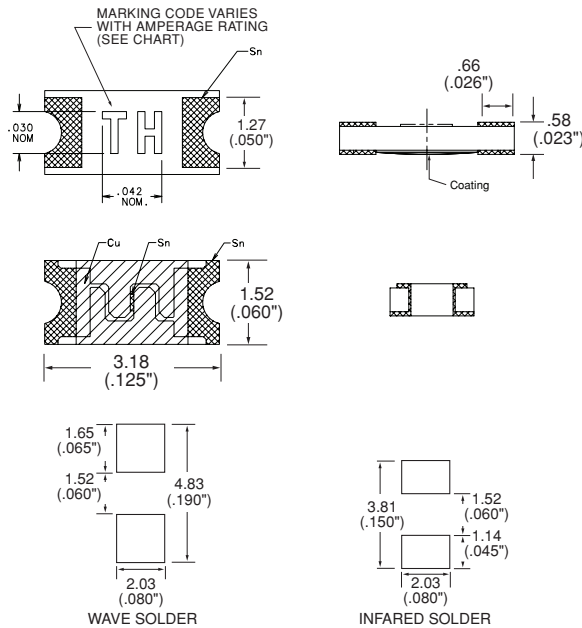

Part Marking System

Amp Code	Marking Code
.500	TF
001.	TH
01.5	TK
002.	TN
02.5	TO
003.	TP

Part Numbering System

0468002.NRHF

SERIES _____

AMP Code _____

The dot is positioned before the Packaging Suffix with whole ratings and within the numbering sequence for fractional ratings. Refer to Amp Code column in the Electrical Specifications table.

PACKAGING Code _____

NR = Tape and Reel, 5000 pcs

'HF' SUFFIX

HALOGEN FREE ITEM

Example:
1.5 amp product is 0468**01.5**NRHF (2 amp product shown above).

Packaging

Packaging Option	Packaging Specification	Quantity	Quantity & Packaging Code
Tape & Reel – 8mm tape	EIA-481 Rev. D (IEC 60286, part 3)	5000	NR