

KEMET Part Number: SC-20-201
(UALSC202010000)

KEMET, SC, AC Line Filters, Common Mode, 2000 uH

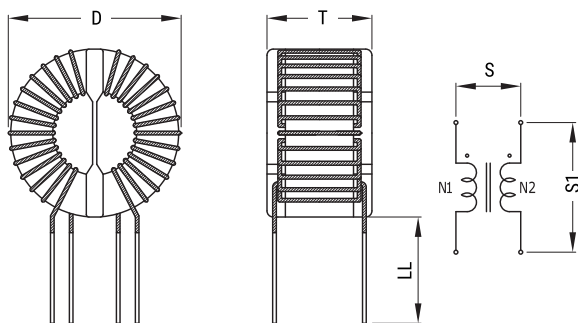

Dimensions

D	49mm MAX
T	30mm MAX
LL	15mm +/-2mm
S	10mm NOM

Packaging Specifications

Packaging:	Tray
Packaging Quantity:	60
Weight:	108.5 g

General Information

Series:	SC
Style:	Through-Hole
RoHS:	Yes
Notes:	Lead Spacing (S/S1) Are For Reference Only.
Miscellaneous:	Temperature Rise Maximum: 75 K

Specifications

Voltage AC:	250 VAC
Inductance:	2 mH (10 kHz)
Current:	20 A
Temperature Range:	-25/+120°C
DC Resistance:	10 mOhms