



Micro Commercial Components



Micro Commercial Components
20736 Marilla Street Chatsworth
CA 91311
Phone: (818) 701-4933
Fax: (818) 701-4939

2SC3265-O
2SC3265-Y

Features

- Halogen free available upon request by adding suffix "-HF"
- Lead Free Finish/RoHS Compliant ("P" Suffix designates RoHS Compliant. See ordering information)
- Power switching application
- Complementary to 2SA1298
- Low frequency power amplifier application
- Epoxy meets UL 94 V-0 flammability rating
- Moisture Sensitivity Level 1

Maximum Ratings

Symbol	Rating	Rating	Unit
V_{CEO}	Collector-Emitter Voltage	30	V
V_{CBO}	Collector-Base Voltage	35	V
V_{EBO}	Emitter-Base Voltage	5.0	V
I_C	Collector Current, Continuous	0.8	A
P_D	Power Dissipation	0.2	W
T_J	Operating Junction Temperature	-55 to +150	$^{\circ}C$
T_{STG}	Storage Temperature	-55 to +150	$^{\circ}C$

Electrical Characteristics @ 25°C Unless Otherwise Specified

Symbol	Parameter	Min	Type	Max	Units
$V_{(BR)CEO}$	Collector-Emitter Breakdown Voltage* ($I_C=10mA$, $I_B=0$)	30			Vdc
$V_{(BR)CBO}$	Collector-Base Breakdown Voltage ($I_C=0.1mA$, $I_E=0$)	35			Vdc
$V_{(BR)EBO}$	Emitter-Base Breakdown Voltage ($I_E=0.1mA$, $I_C=0$)	5.0			Vdc
I_{CBO}	Collector cut-off Current ($V_{CB}=30Vdc$, $I_E=0$)			0.1	μA
I_{EBO}	Emitter cut-off Current ($V_{EB}=5Vdc$, $I_C=0$)			0.1	μA
h_{FE}	DC Current Gain ($I_C=10mA$, $V_{CE}=1.0Vdc$)	100		320	
$V_{CE(sat)}$	Collector-Emitter Saturation Voltage ($I_C=500mA$, $I_B=20mA$)			0.5	Vdc
V_{BE}	Base-Emitter Voltage ($I_C=10mA$, $V_{CE}=1Vdc$)	0.5		0.8	Vdc
f_T	Transition Frequency ($I_C=10mA$, $V_{CE}=5Vdc$, $f=100MHz$)		120		MHz
C_{ob}	Collector output capacitance ($I_E=0$, $V_{CB}=10Vdc$, $f=1MHz$)		13		pF

CLASSIFICATION OF $h_{FE(1)}$

Rank	O	Y
Range	100-200	160-320
MARKING	EO	EY

NPN General Purpose Amplifier

SOT-23

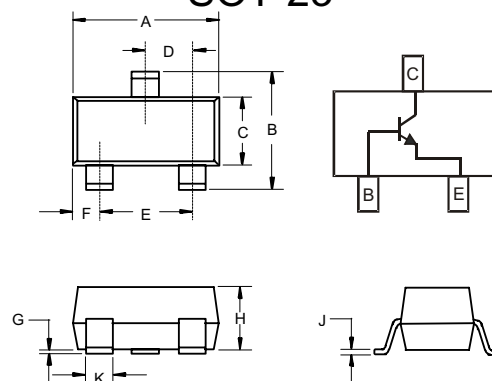

DIM	INCHES		MM		NOTE
	MIN	MAX	MIN	MAX	
A	.110	.120	2.80	3.04	
B	.083	.104	2.10	2.64	
C	.047	.055	1.20	1.40	
D	.035	.041	.89	1.03	
E	.070	.081	1.78	2.05	
F	.018	.024	.45	.60	
G	.0005	.0039	.013	.100	
H	.035	.044	.89	1.12	
J	.003	.007	.085	.180	
K	.015	.020	.37	.51	

Suggested Solder Pad Layout

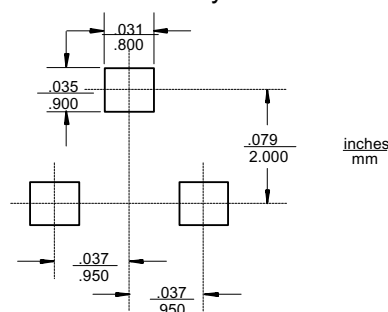

www.mccsemi.com

2SC3265

$I_C - V_{CE}$

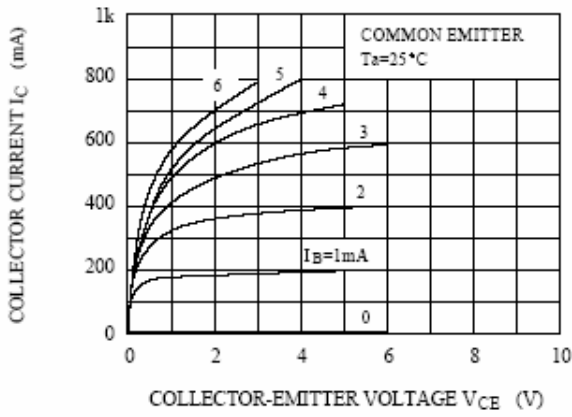

$h_{FE} - I_C$

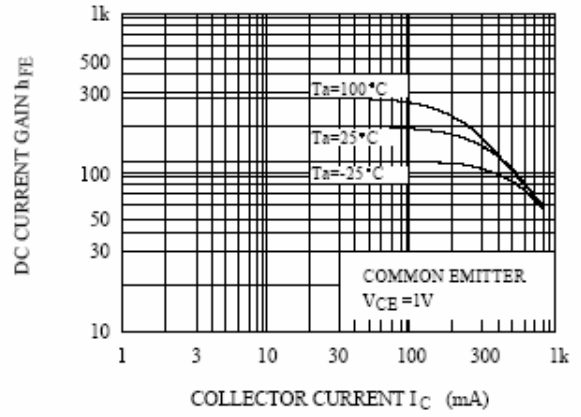

$V_{CE(sat)} - I_C$

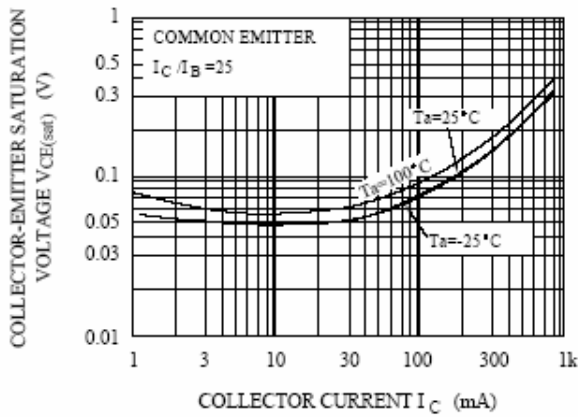

$I_C - V_{BE}$

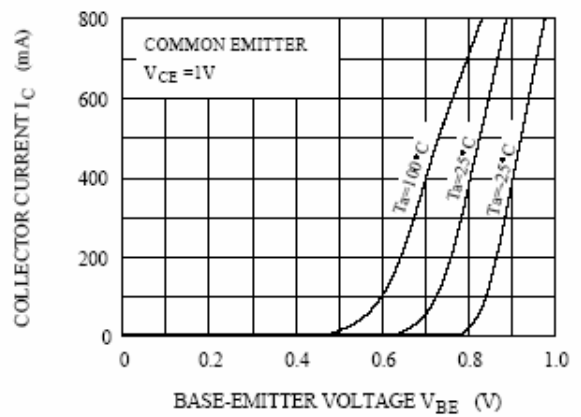

$P_C - T_a$

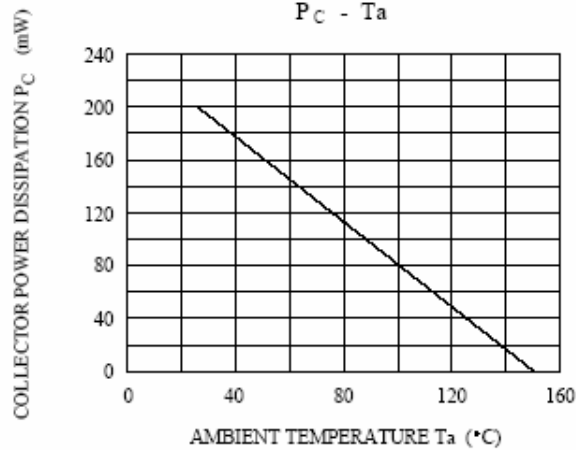



Micro Commercial Components

Ordering Information :

Device	Packing
Part Number-TP	Tape&Reel; 3Kpcs/Reel

Note : Adding "-HF" suffix for halogen free, eg. Part Number-TP-HF

IMPORTANT NOTICE

Micro Commercial Components Corp. reserves the right to make changes without further notice to any product herein to make corrections, modifications, enhancements, improvements, or other changes. **Micro Commercial Components Corp.** does not assume any liability arising out of the application or use of any product described herein; neither does it convey any license under its patent rights, nor the rights of others. The user of products in such applications shall assume all risks of such use and will agree to hold **Micro Commercial Components Corp.** and all the companies whose products are represented on our website, harmless against all damages.

LIFE SUPPORT

MCC's products are not authorized for use as critical components in life support devices or systems without the express written approval of Micro Commercial Components Corporation.

CUSTOMER AWARENESS

Counterfeiting of semiconductor parts is a growing problem in the industry. Micro Commercial Components (MCC) is taking strong measures to protect ourselves and our customers from the proliferation of counterfeit parts. MCC strongly encourages customers to purchase MCC parts either directly from MCC or from Authorized MCC Distributors who are listed by country on our web page cited below. Products customers buy either from MCC directly or from Authorized MCC Distributors are genuine parts, have full traceability, meet MCC's quality standards for handling and storage. **MCC will not provide any warranty coverage or other assistance for parts bought from Unauthorized Sources.** MCC is committed to combat this global problem and encourage our customers to do their part in stopping this practice by buying direct or from authorized distributors.

www.mccsemi.com