

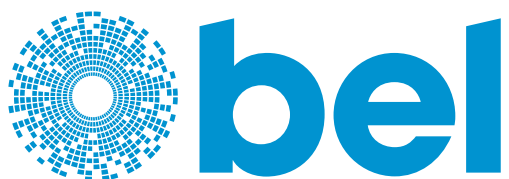

Cable Catalog



belfuse.com



About Bel

Bel is a publicly traded company that has been operated by the same family for over 65 years. Our history of organic growth and acquisitions have broadened our product portfolio. This has established Bel as a world leader with a diverse offering of power, protection and interconnect products. We design and manufacture these products which are primarily used in the networking, telecommunications, computing, military, aerospace, transportation and broadcasting industries. Bel's portfolio of products also finds application in the automotive, medical and consumer electronics markets.

Table of Contents

Cat 5e & Cat 6 24 AWG

Channel Compliant Patch Cords

Description, part number table and part number structure 3

Cat 6a UTP and STP Channel Compliant Patch Cords

Description, part number table and part number structure 4

Cat 5e, Cat 6 24 & Cat 6 26 AWG Component Compliant Patch Cords

Description, part number table and part number structure 5

Cat 6 & Cat 6a Reduced Diameter (28 AWG) Patch Cords

Description, part number table and part number structure 6

Cat 6 Reduced Diameter (28 AWG) Channel Compliant Patch Cords

Description, part number table and part number structure 7

IP20 Patch Cords

Description, part number table and part number structure 8

Cat 6 and Cat 6A Plenum Patch Cords

Description, part number table and part number structure 9

USB Cable Assemblies

Description, part number table and part number structure 10-12

Fiber Optic Cable Assemblies

Description and part number table 13

Straight and Reverse Modular Cable Assemblies

Description, part number table and part number structure 14

HDMI Cable Assemblies

Description, part number table and part number structure 15

DisplayPort Cable Assemblies

Description, part number table and part number structure 16

M12 X-Code Cable Assemblies

Description, part number table and part number structure 17-18

DVI Cable Assemblies

Description, part number table and part number structure 19

USB Type-C Adapter Cable Assemblies

Description, part number table and part number structure 20

IP67 USB Cable Assemblies

Description, part number table and part number structure 21

RJ45 Plug to RJ45 Jack Assemblies

Description, part number table and part number structure 22

MPO Cable Assemblies

Description, part number table and part number structure 23

3.5mm Audio Cables

Description, part number table and part number structure 24

Power Cords

Description, part number table and part number structure 25

Cat 5e & Cat 6 24 AWG Channel Compliant Patch Cords

Description

Bel's Cat 6 patch cords support voice communications and the transmission of 1G, 2.5G and 5G data speeds, while also offering Cat 5e patch cords that support 1G and 2.5G data speeds. Channel compliant patch cords feature UL rated CM jacket material in multiple lengths and colors, along with color-matching slim line snagless strain relief boots.



Bel Part Number	Rating	Shielded	Color	Lengths Available		AWG Size
				ft	m	
BC-5UE001F	Cat 5e	No	Blue	1ft	0.30m	24 AWG
BC-5UE003F	Cat 5e	No	Blue	3ft	0.91m	24 AWG
BC-5UE005F	Cat 5e	No	Blue	5ft	1.52m	24 AWG
BC-5UE007F	Cat 5e	No	Blue	7ft	2.13m	24 AWG
BC-5UE010F	Cat 5e	No	Blue	10ft	3.04m	24 AWG
BC-5UE015F	Cat 5e	No	Blue	15ft	4.57m	24 AWG
BC-5UE020F	Cat 5e	No	Blue	20ft	6.09m	24 AWG
BC-5UE025F	Cat 5e	No	Blue	25ft	7.62m	24 AWG
BC-5UG001F	Cat 5e	No	Grey	1ft	0.30m	24 AWG
BC-5UG003F	Cat 5e	No	Grey	3ft	0.91m	24 AWG
BC-5UG005F	Cat 5e	No	Grey	5ft	1.52m	24 AWG
BC-5UG007F	Cat 5e	No	Grey	7ft	2.13m	24 AWG
BC-5UG010F	Cat 5e	No	Grey	10ft	3.04m	24 AWG
BC-5UG015F	Cat 5e	No	Grey	15ft	4.57m	24 AWG
BC-5UG020F	Cat 5e	No	Grey	20ft	6.09m	24 AWG
BC-5UG025F	Cat 5e	No	Grey	25ft	7.62m	24 AWG
BC-6UE001F	Cat 6	No	Blue	1ft	0.30m	24 AWG
BC-6UE003F	Cat 6	No	Blue	3ft	0.91m	24 AWG
BC-6UE005F	Cat 6	No	Blue	5ft	1.52m	24 AWG
BC-6UE007F	Cat 6	No	Blue	7ft	2.13m	24 AWG
BC-6UE010F	Cat 6	No	Blue	10ft	3.04m	24 AWG
BC-6UE015F	Cat 6	No	Blue	15ft	4.57m	24 AWG
BC-6UE020F	Cat 6	No	Blue	20ft	6.09m	24 AWG
BC-6UE025F	Cat 6	No	Blue	25ft	7.62m	24 AWG
BC-6UG001F	Cat 6	No	Grey	1ft	0.30m	24 AWG
BC-6UG003F	Cat 6	No	Grey	3ft	0.91m	24 AWG
BC-6UG005F	Cat 6	No	Grey	5ft	1.52m	24 AWG
BC-6UG007F	Cat 6	No	Grey	7ft	2.13m	24 AWG
BC-6UG010F	Cat 6	No	Grey	10ft	3.04m	24 AWG
BC-6UG015F	Cat 6	No	Grey	15ft	4.57m	24 AWG
BC-6UG020F	Cat 6	No	Grey	20ft	6.09m	24 AWG
BC-6UG025F	Cat 6	No	Grey	25ft	7.62m	24 AWG

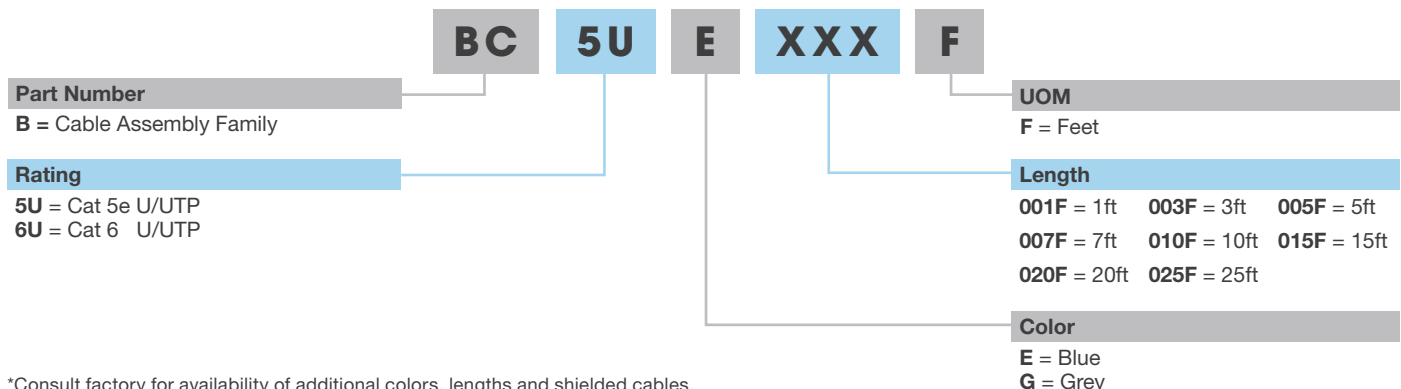

*Consult factory for availability of additional colors, lengths and shielded cables.

Cat 6a UTP and STP Channel Compliant Patch Cords

Description

Bel's Cat 6a patch cords support voice communications and the transmission of 1G, 2.5G and 5G data speeds and 10G. Both shielded and unshielded options are available. Channel compliant patch cords feature UL rated CM jacket material in multiple lengths and colors, along with color-matching slim line snagless strain relief boots.



Bel Part Number	Rating	Shielded	Color	Lengths Available		AWG Size
				ft	m	
BC-1UG001F	Cat 6a	No	Grey	1ft	0.30m	24 AWG
BC-1UG002F	Cat 6a	No	Grey	2ft	0.60m	24 AWG
BC-1UG003F	Cat 6a	No	Grey	3ft	0.91m	24 AWG
BC-1UG005F	Cat 6a	No	Grey	5ft	1.52m	24 AWG
BC-1UG006F	Cat 6a	No	Grey	6ft	1.82m	24 AWG
BC-1UG007F	Cat 6a	No	Grey	7ft	2.13m	24 AWG
BC-1UG010F	Cat 6a	No	Grey	10ft	3.04m	24 AWG
BC-1UG015F	Cat 6a	No	Grey	15ft	4.57m	24 AWG
BC-1UG020F	Cat 6a	No	Grey	20ft	6.09m	24 AWG
BC-1UG025F	Cat 6a	No	Grey	25ft	7.62m	24 AWG
BC-1UE001F	Cat 6a	No	Blue	1ft	0.30m	24 AWG
BC-1UE002F	Cat 6a	No	Blue	2ft	0.60m	24 AWG
BC-1UE003F	Cat 6a	No	Blue	3ft	0.91m	24 AWG
BC-1UE005F	Cat 6a	No	Blue	5ft	1.52m	24 AWG
BC-1UE006F	Cat 6a	No	Blue	6ft	1.82m	24 AWG
BC-1UE007F	Cat 6a	No	Blue	7ft	2.13m	24 AWG
BC-1UE010F	Cat 6a	No	Blue	10ft	3.04m	24 AWG
BC-1UE015F	Cat 6a	No	Blue	15ft	4.57m	24 AWG
BC-1UE020F	Cat 6a	No	Blue	20ft	6.09m	24 AWG
BC-1UE025F	Cat 6a	No	Blue	25ft	7.62m	24 AWG
BC-1SE001F	Cat 6a	Yes	Blue	1ft	0.30m	24 AWG
BC-1SE003F	Cat 6a	Yes	Blue	3ft	0.91m	24 AWG
BC-1SE005F	Cat 6a	Yes	Blue	5ft	1.52m	24 AWG
BC-1SE007F	Cat 6a	Yes	Blue	7ft	2.13m	24 AWG
BC-1SE010F	Cat 6a	Yes	Blue	10ft	3.04m	24 AWG
BC-1SE014F	Cat 6a	Yes	Blue	14ft	4.26m	24 AWG
BC-1SE025F	Cat 6a	Yes	Blue	25ft	7.62m	24 AWG

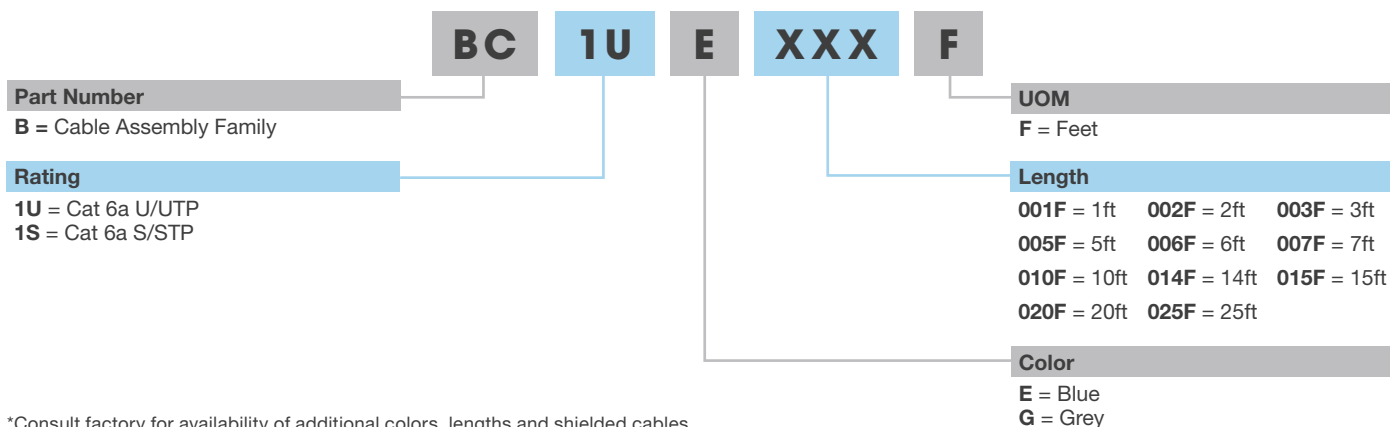

*Consult factory for availability of additional colors, lengths and shielded cables.

Cat 5e, Cat 6 24 & Cat 6 26 AWG Component Compliant Patch Cords

Description

Bel's patch cords support voice communications and the transmission of 1G, 2.5G and 5G data speeds, while also offering Cat 6a patch cords that support up to 10G data speeds. Bel's component compliant patch cords feature UL rated CM jacket material in multiple lengths and colors, along with color-matching slim line snagless strain relief boots. These component compliant patch cords are 100% transmission tested for performance.



Bel Part Number	Rating	Shielded	Color	Lengths Available		AWG Size
				ft	m	
BM-5UE001F	Cat 5e	No	Blue	1ft	0.30m	24 AWG
BM-5UE003F	Cat 5e	No	Blue	3ft	0.91m	24 AWG
BM-5UE005F	Cat 5e	No	Blue	5ft	1.52m	24 AWG
BM-5UE007F	Cat 5e	No	Blue	7ft	2.13m	24 AWG
BM-5UE010F	Cat 5e	No	Blue	10ft	3.04m	24 AWG
BM-5UE015F	Cat 5e	No	Blue	15ft	4.57m	24 AWG
BM-5UG001F	Cat 5e	No	Grey	1ft	0.30m	24 AWG
BM-5UG003F	Cat 5e	No	Grey	3ft	0.91m	24 AWG
BM-5UG005F	Cat 5e	No	Grey	5ft	1.52m	24 AWG
BM-5UG007F	Cat 5e	No	Grey	7ft	2.13m	24 AWG
BM-5UG010F	Cat 5e	No	Grey	10ft	3.04m	24 AWG
BM-5UG015F	Cat 5e	No	Grey	15ft	4.57m	24 AWG
BM-6UE001F	Cat 6	No	Blue	1ft	0.30m	24 AWG
BM-6UE003F	Cat 6	No	Blue	3ft	0.91m	24 AWG
BM-6UE005F	Cat 6	No	Blue	5ft	1.52m	24 AWG
BM-6UE007F	Cat 6	No	Blue	7ft	2.13m	24 AWG
BM-6UE010F	Cat 6	No	Blue	10ft	3.04m	24 AWG
BM-6UE015F	Cat 6	No	Blue	15ft	4.57m	24 AWG
BM-6UG001F	Cat 6	No	Grey	1ft	0.30m	24 AWG
BM-6UG003F	Cat 6	No	Grey	3ft	0.91m	24 AWG
BM-6UG005F	Cat 6	No	Grey	5ft	1.52m	24 AWG
BM-6UG007F	Cat 6	No	Grey	7ft	2.13m	24 AWG
BM-6UG010F	Cat 6	No	Grey	10ft	3.04m	24 AWG
BM-6UG015F	Cat 6	No	Grey	15ft	4.57m	24 AWG
BM-6ASE001F	Cat 6a	Yes	Blue	1ft	0.30m	26 AWG
BM-6ASE003F	Cat 6a	Yes	Blue	3ft	0.91m	26 AWG
BM-6ASE005F	Cat 6a	Yes	Blue	5ft	1.52m	26 AWG
BM-6ASE007F	Cat 6a	Yes	Blue	7ft	2.13m	26 AWG
BM-6ASE010F	Cat 6a	Yes	Blue	10ft	3.04m	26 AWG
BM-6ASE015F	Cat 6a	Yes	Blue	15ft	4.57m	26 AWG
BM-6ASG001F	Cat 6a	Yes	Grey	1ft	0.30m	26 AWG
BM-6ASG003F	Cat 6a	Yes	Grey	3ft	0.91m	26 AWG
BM-6ASG005F	Cat 6a	Yes	Grey	5ft	1.52m	26 AWG
BM-6ASG007F	Cat 6a	Yes	Grey	7ft	2.13m	26 AWG
BM-6ASG010F	Cat 6a	Yes	Grey	10ft	3.04m	26 AWG
BM-6ASG015F	Cat 6a	Yes	Grey	15ft	4.57m	26 AWG

Part Number

BM = Cable Assembly Family

BM

6AS

E

XXX

F

UOM

F = Feet

Rating

6AS = Cat 6 26 AWG F/UTP

5U = Cat 6 26 AWG F/UTP

6U = Cat 6 24 AWG U/UTP

Length

001F = 1ft 003F = 3ft 005F = 5ft

007F = 7ft 010F = 10ft 015F = 15ft

Colour

E = Blue

G = Grey



Cat 6 & Cat 6a Reduced Diameter (28 AWG) Patch Cords

Description

Bel's Cat 6 reduced diameter patch cords support voice communications and the transmission of 1G, 2.5G and 5G data speeds, while also offering Cat 6a patch cords that support up to 10G data speeds. The 28 AWG patch cords are ideal for high density data center applications where increased airflow and reduced congestion are beneficial. Bel's reduced diameter patch cords feature UL rated CM jacket material in multiple lengths and colors, along with color-matching slim line snagless strain relief boots. All reduced diameter patch cords are 100% Transmission Tested for performance.

Bel Part Number	Rating	Shielded	Color	Lengths Available		AWG Size
				ft	m	
BM-R6UE001F	Cat 6	No	Blue	1ft	0.30m	28 AWG (Reduced Diameter)
BM-R6UE003F	Cat 6	No	Blue	3ft	0.91m	28 AWG (Reduced Diameter)
BM-R6UE005F	Cat 6	No	Blue	5ft	1.52m	28 AWG (Reduced Diameter)
BM-R6UE007F	Cat 6	No	Blue	7ft	2.13m	28 AWG (Reduced Diameter)
BM-R6UE010F	Cat 6	No	Blue	10ft	3.04m	28 AWG (Reduced Diameter)
BM-R6UE015F	Cat 6	No	Blue	15ft	4.57m	28 AWG (Reduced Diameter)
BM-R6UG001F	Cat 6	No	Grey	1ft	0.30m	28 AWG (Reduced Diameter)
BM-R6UG003F	Cat 6	No	Grey	3ft	0.91m	28 AWG (Reduced Diameter)
BM-R6UG005F	Cat 6	No	Grey	5ft	1.52m	28 AWG (Reduced Diameter)
BM-R6UG007F	Cat 6	No	Grey	7ft	2.13m	28 AWG (Reduced Diameter)
BM-R6UG010F	Cat 6	No	Grey	10ft	3.04m	28 AWG (Reduced Diameter)
BM-R6UG015F	Cat 6	No	Grey	15ft	4.57m	28 AWG (Reduced Diameter)
BM-R6ASE001F	Cat 6a	Yes	Blue	1ft	0.30m	28 AWG (Reduced Diameter)
BM-R6ASE003F	Cat 6a	Yes	Blue	3ft	0.91m	28 AWG (Reduced Diameter)
BM-R6ASE005F	Cat 6a	Yes	Blue	5ft	1.52m	28 AWG (Reduced Diameter)
BM-R6ASE007F	Cat 6a	Yes	Blue	7ft	2.13m	28 AWG (Reduced Diameter)
BM-R6ASE010F	Cat 6a	Yes	Blue	10ft	3.04m	28 AWG (Reduced Diameter)
BM-R6ASE015F	Cat 6a	Yes	Blue	15ft	4.57m	28 AWG (Reduced Diameter)
BM-R6ASG001F	Cat 6a	Yes	Grey	1ft	0.30m	28 AWG (Reduced Diameter)
BM-R6ASG003F	Cat 6a	Yes	Grey	3ft	0.91m	28 AWG (Reduced Diameter)
BM-R6ASG005F	Cat 6a	Yes	Grey	5ft	1.52m	28 AWG (Reduced Diameter)
BM-R6ASG007F	Cat 6a	Yes	Grey	7ft	2.13m	28 AWG (Reduced Diameter)
BM-R6ASG010F	Cat 6a	Yes	Grey	10ft	3.04m	28 AWG (Reduced Diameter)
BM-R6ASG015F	Cat 6a	Yes	Grey	15ft	4.57m	28 AWG (Reduced Diameter)

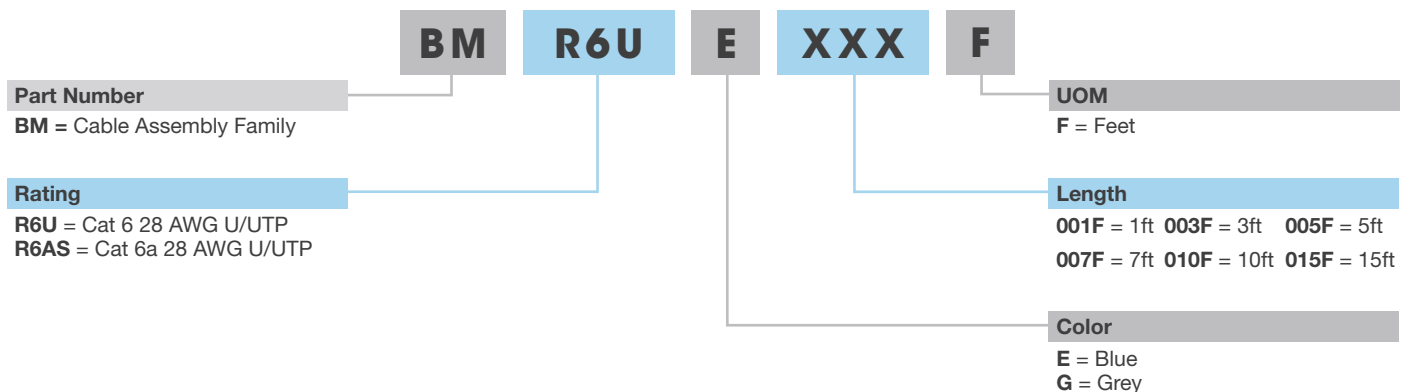

Cat 6 Reduced Diameter (28 AWG) Channel Compliant Patch Cords

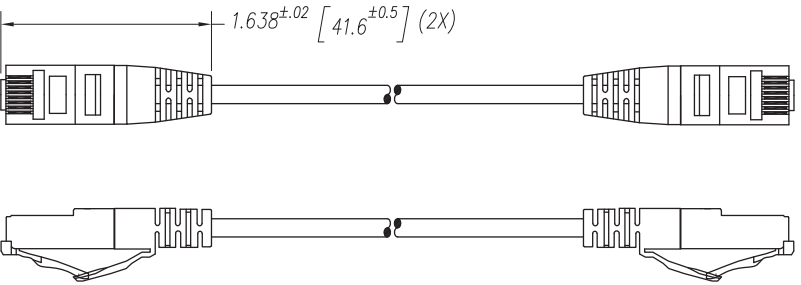

Description

Bel's Cat 6 channel compliant reduced diameter patch cords support voice communications and the transmission of 1G, 2.5G and 5G data speeds. The 28 AWG patch cords are ideal for high density data center applications where increased airflow and reduced congestion are beneficial. Bel's reduced diameter patch cords feature UL rated CM jacket material in multiple lengths and colors, along with color-matching slim line snagless strain relief boots.

Bel Part Number	Rating	Shielded	Color	Lengths Available		AWG Size
				ft	m	
BC-R6UE001F	Cat 6	No	Blue	1ft	0.30m	28 AWG (Reduced Diameter)
BC-R6UE003F	Cat 6	No	Blue	3ft	0.91m	28 AWG (Reduced Diameter)
BC-R6UE005F	Cat 6	No	Blue	5ft	1.52m	28 AWG (Reduced Diameter)
BC-R6UE007F	Cat 6	No	Blue	7ft	2.13m	28 AWG (Reduced Diameter)
BC-R6UE010F	Cat 6	No	Blue	10ft	3.04m	28 AWG (Reduced Diameter)
BC-R6UE015F	Cat 6	No	Blue	15ft	4.57m	28 AWG (Reduced Diameter)

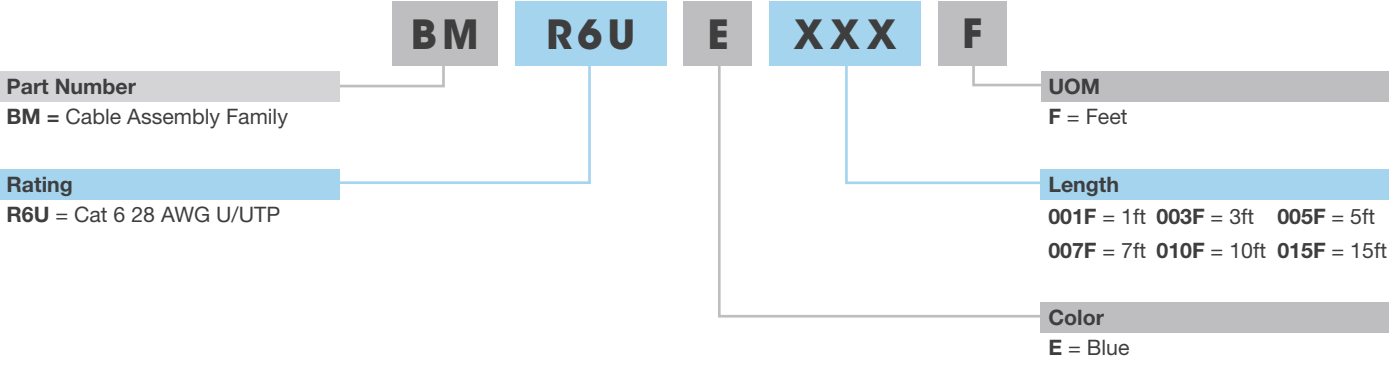

IP20 Patch Cords

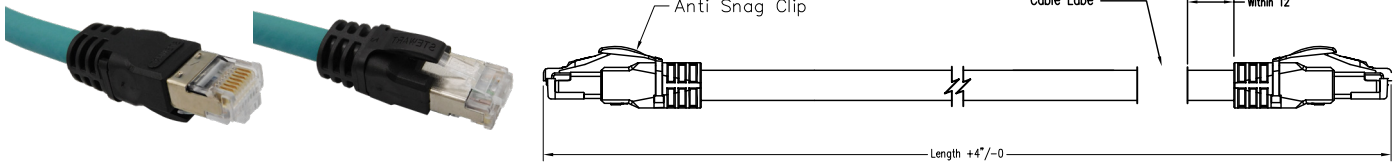

Description

Bel's industrial patch cord line offers reliable Ethernet transmissions through a robust design that withstands conditions found in factory and industrial environments. Available in both Cat 5e and Cat 6a performance levels, Bel's industrial patch cords are shielded and feature a TPE cable jacket. The TPE cable jacket is oil and sunlight resistant making these patch cords suitable for many different environments. Bel's industrial patch cords also feature over molded IP20 rated RJ45 plugs. The addition of over molded boots prevent the locking lever from kinking and offers additional strain relief and bend protection. Available in multiple lengths, the industrial patch cords from Bel offer a variety of solutions.

Bel Part Number	Category	Shielded	Color	Lengths Available	
				ft	m
BM-5ST001F01	Cat 5e	Yes	Teal	1ft	0.30m
BM-5ST003F01	Cat 5e	Yes	Teal	3ft	0.91m
BM-5ST005F01	Cat 5e	Yes	Teal	5ft	1.52m
BM-5ST007F01	Cat 5e	Yes	Teal	7ft	2.13m
BM-5ST010F01	Cat 5e	Yes	Teal	10ft	3.04m
BM-5ST015F01	Cat 5e	Yes	Teal	15ft	4.57m
BM-5ST020F01	Cat 5e	Yes	Teal	20ft	6.09m
BM-5ST025F01	Cat 5e	Yes	Teal	25ft	7.62m
BM-5ST030F01	Cat 5e	Yes	Teal	30ft	9.14m
BM-1ST001F01	Cat 6a	Yes	Teal	1ft	0.30m
BM-1ST003F01	Cat 6a	Yes	Teal	3ft	0.91m
BM-1ST005F01	Cat 6a	Yes	Teal	5ft	1.52m
BM-1ST007F01	Cat 6a	Yes	Teal	7ft	2.13m
BM-1ST010F01	Cat 6a	Yes	Teal	10ft	3.04m
BM-1ST015F01	Cat 6a	Yes	Teal	15ft	4.57m
BM-1ST020F01	Cat 6a	Yes	Teal	20ft	6.09m
BM-1ST025F01	Cat 6a	Yes	Teal	25ft	7.62m
BM-1ST030F01	Cat 6a	Yes	Teal	30ft	9.14m

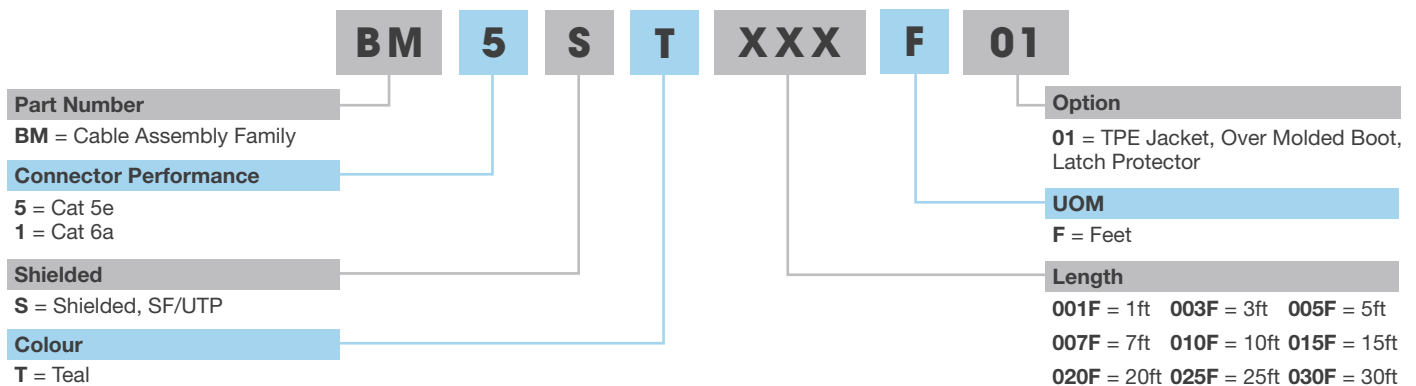

Cat 6 and Cat 6a Plenum Patch Cords

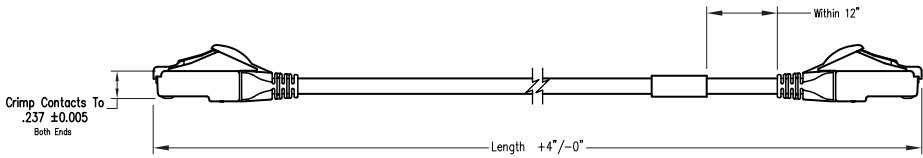

Description

Bel's Plenum patch cords are ideal for Ethernet network connections that require patch cords to run through plenum space above dropped ceilings or under raised floors. The Plenum jacketing on these patch cords is coated with flame retardant. Bel's Plenum patch cords are also built using special plastics that resist sweltering and the spreading of toxic fumes in the case of a fire. Plenum rated patch cords should be used in any plenum space for these reasons. These Plenum patch cords have standard RJ45 plugs on each end, equipped with snag-less boots to protect the RJ45 clip during pulls through tight locations. Bel's Plenum patch cords are available in both Cat 6 and Cat 6a performance levels.

Bel Part Number	Performance	Lengths Available		Color	Cable Jacket Type	AWG Size
		ft	m			
BM-P6SK003F	Cat 6	3ft	0.91m	Black	Plenum	26 AWG
BM-P6SK007F	Cat 6	7ft	2.13m	Black	Plenum	26 AWG
BM-P6SK015F	Cat 6	15ft	4.57m	Black	Plenum	26 AWG
BM-P6SK030F	Cat 6	30ft	9.14m	Black	Plenum	26 AWG
BM-P1SK003F	Cat 6a	3ft	0.91m	Black	Plenum	26 AWG
BM-P1SK007F	Cat 6a	7ft	2.13m	Black	Plenum	26 AWG
BM-P1SK0015F	Cat 6a	15ft	4.57m	Black	Plenum	26 AWG
BM-P1SK030F	Cat 6a	30ft	9.14m	Black	Plenum	26 AWG

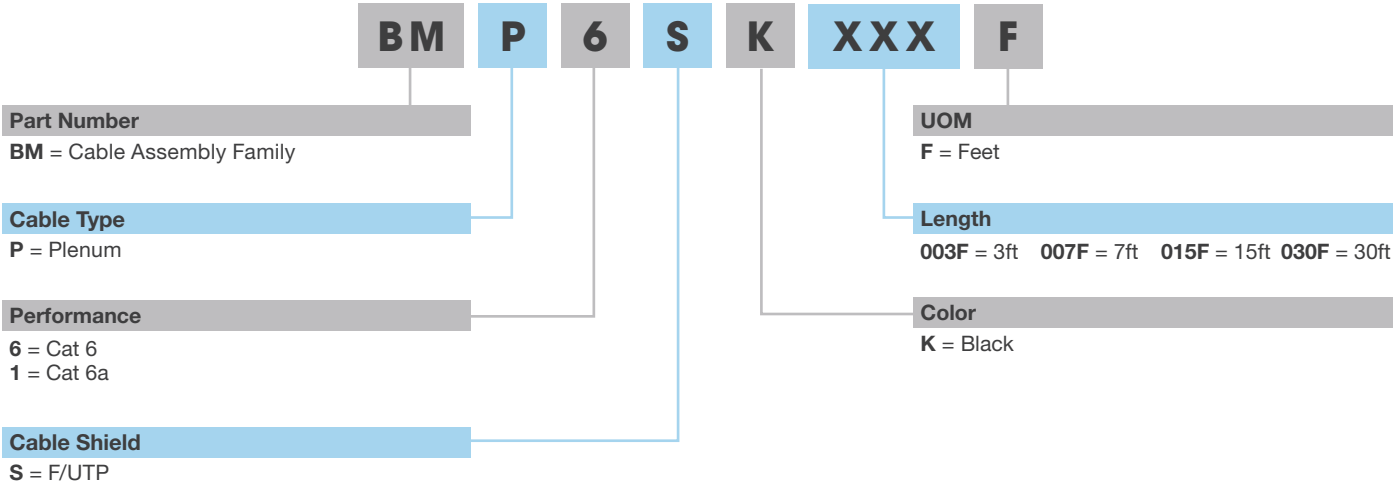

USB Cable Assemblies



Connector End A Options



Connector End B Options

Description

Bel offers a wide range of USB cable assemblies featuring multiple end configurations for USB 2.0, 3.0 and 3.1. Bel's USB cable assemblies are compliant with USB 2.0, 3.0 and 3.1 standards. USB 2.0 delivers up to 480 Mbps transfer speeds, USB 3.0 delivers up to 5 Gbps and USB 3.1 can deliver up to 10 Gbps transfer speeds. All the available cable assembly options are equipped with an over molded design to increase strain relief, along with full shielding to allow power to be supplied over a communication signal. Bel's USB cable assemblies feature plug and play capability that allows for hot pluggable insertion and ejection.

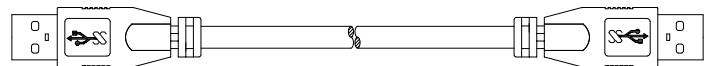

USB Type A to Type A

Bel Part Number	Performance	Connector End A	Connector End B	Lengths Available (XXX)			Shielded	Color
SC-2AAEXXXF	USB 2.0	A Male	A Male	003 = 3ft (XXX)	006 = 6ft (XXX)		Yes	Beige
SC-3AAKXXXF	USB 3.0	A Male	A Male	003 = 3ft (XXX)	006 = 6ft (XXX)	010 = 10ft (XXX)	Yes	Black

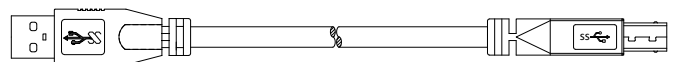

USB Type A to Type B

Bel Part Number	Performance	Connector End A	Connector End B	Lengths Available (XXX)			Shielded	Color
SC-2ABEXXXF	USB 2.0	A Male	B Male	003 = 3ft (XXX)	006 = 6ft (XXX)		Yes	Beige
SC-3ABKXXXF	USB 3.0	A Male	B Male	001 = 1ft (XXX)	003 = 3ft (XXX)	006 = 6ft (XXX)	Yes	Black

USB Cable Assemblies

USB Type A to Micro B

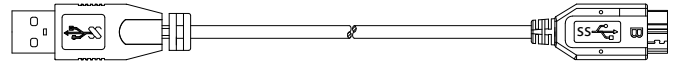

Bel Part Number	Performance	Connector End A	Connector End B	Lengths Available (XXX)			Shielded	Color
SC-2AMKXXXF	USB 2.0	A Male	Micro B Male	003 = 3ft (XXX)	006 = 6ft (XXX)		Yes	Black
SC-3ATKXXXF	USB 3.0	A Male	Micro B Male	001 = 1ft (XXX)	003 = 3ft (XXX)	006 = 6ft (XXX)	Yes	Black

USB Type A to Mini B

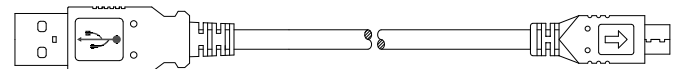

Bel Part Number	Performance	Connector End A	Connector End B	Lengths Available (XXX)			Shielded	Color
SC-2ANKXXXF	USB 2.0	A Male	Mini B Male	003 = 3ft (XXX)	006 = 6ft (XXX)	010 = 10ft (XXX)	Yes	Black

USB Type C to Micro B



Bel Part Number	Performance	Connector End A	Connector End B	Lengths Available (XXX)		Shielded	Color
SC-2CMKXXXM	USB 2.0	C Male	Micro B Male	010 = 1m (XXX)	020 = 2m (XXX)	Yes	Black

USB Type C to Type C

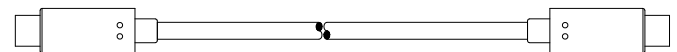

Bel Part Number	Performance	Connector End A	Connector End B	Lengths Available (XXX)	Shielded	Color
SC-3CCKXXXM	USB 3.1	C Male	C Male	010 = 1m (XXX)	Yes	Black

USB Type C to Type A

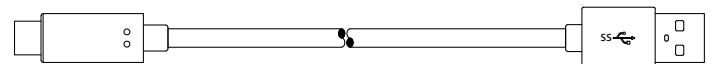

Bel Part Number	Performance	Connector End A	Connector End B	Lengths Available (XXX)	Shielded	Color	
SC-2CAKXXXM	USB 2.0	C Male	A Male	010 = 1m (XXX)	020 = 2m (XXX)	Yes	Black
SC-3CAKXXXM	USB 3.0	C Male	A Male	010 = 1m (XXX)		Yes	Black

USB Cable Assemblies

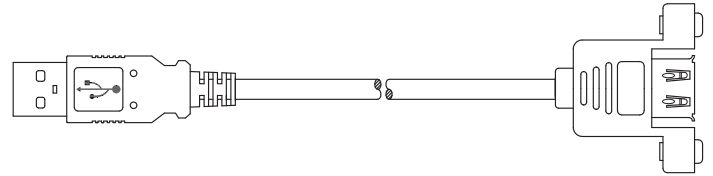

USB Type A to Type A Panel Mount

Bel Part Number	Performance	Connector End A	Connector End B	Lengths Available (XXX)	Shielded	Color
SC-3APKXXXF	USB 3.0	A Male	Panel Mount A Female	001 = 1ft (XXX)	Yes	Black
SC-2APKXXXF	USB 2.0	A Male	Panel Mount A Female	001 = 1ft (XXX)	Yes	Black

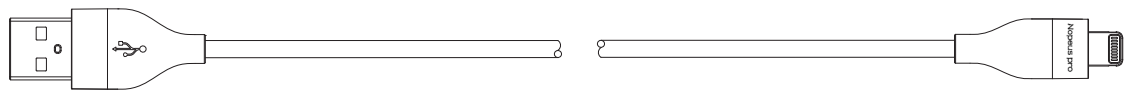

USB to Lightning Cable Assemblies

Bel Part Number	Performance	Connector End A	Connector End B	Lengths Available (XXX)	Shielded	Color
SC-2AZK003F	USB 2.0	USB Type-A Male	MiFi C89	003 = 3ft (XXX)	Yes	Black
SC-2AZK006F	USB 2.0	USB Type-A Male	MiFi C89	006 = 6ft (XXX)	Yes	White
SC-2AZW003F	USB 2.0	USB Type-A Male	MiFi C89	003 = 3ft (XXX)	Yes	Black
SC-2AZW006F	USB 2.0	USB Type-A Male	MiFi C89	006 = 6ft (XXX)	Yes	White

SC 2AA E XXX F

Part Number

SC = Cable Assembly Family

Connector Performance

2AAE = USB 2.0 Type A Male to A Male
2ABE = USB 2.0 Type A Male to B Male
2AMK = USB 2.0 Type A Male to Micro B Male
2ANK = USB 2.0 Type A Male to Mini B Male 5-Pin
3AAK = USB 3.0 Type A Male to A Male
3ABK = USB 3.0 Type A Male to B Male
2CAK = USB 2.0 Type C Male to A Male
2CMK = USB 2.0 Type C Male to Micro B Male
3CCK = USB 3.1 Type C Male to C Male
3CAK = USB 3.1 Type C Male to A Male
2ADK = USB 2.0 Type A to Free Cable End
3APK = USB 3.0 Type A Male to Type A Female Panel Mount
2APK = USB 2.0 Type A Male to Type A Female Panel Mount
2AZK = USB 2.0 Type A Male to MiFi C89
2AZW = USB 2.0 Type A Male to MiFi C89

UOM

F = Feet
M = Meters

Length

001F = 1ft **003F** = 3ft **006F** = 6ft
010F = 10ft **016F** = 16ft **010M** = 1m
020M = 2m

Color

E = Beige
K = Black
W = White

Fiber Optic Cable Assemblies

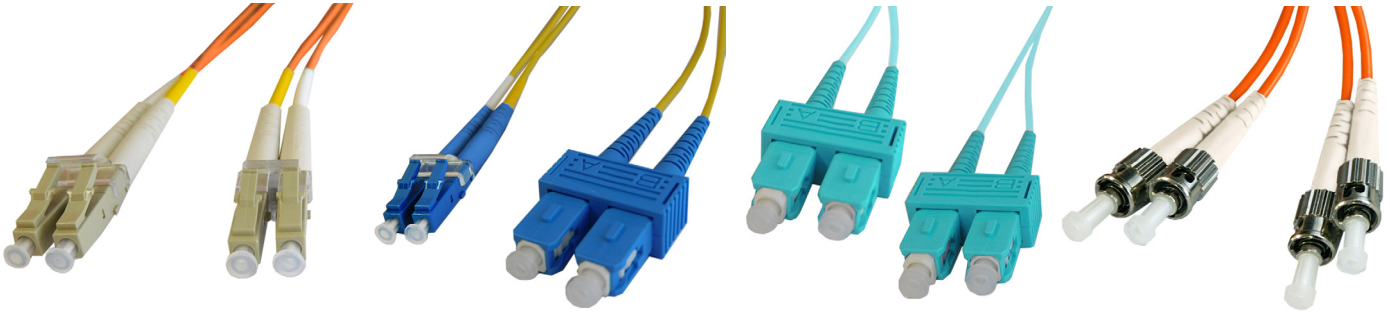

Description

Bel's fiber optic cables are designed to be used in high flex environments due to the tight buffered cable design. All of Bel's fiber optic assemblies are built with Duplex fiber cable with PVC jackets. These fiber optic cables offer a variety of single and multimode configurations for varying high-speed, high-bandwidth applications. Both single and multimode assemblies are available at lengths of 1m, 2m, 3m, 4m and 5m. Single mode assemblies have a cable diameter of 2.0mm and multimode assemblies have a cable diameter of 3.0mm. Color configurations are dependent on end configurations. These cables are also backward compatible with legacy LANs.

LC to LC

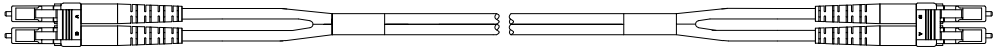

Bel Part Number	Description	Type	Lengths Available (XXX)			
LCLC-6DTPXXX	LC to LC, Orange Cable with Beige Boot	MM, 62.5/125, OM1	010 = 1.0m (XXX)	020 = 2.0m (XXX)	030 = 3.0m (XXX)	050 = 5.0m (XXX)
LCLC-3DTPXXX	LC to LC, Aqua Cable with Aqua Boot	MM, 50/125, OM3	010 = 1.0m (XXX)	020 = 2.0m (XXX)	030 = 3.0m (XXX)	050 = 5.0m (XXX)
LCLC-SDTPXXX	LC to LC, Yellow Cable with Blue Boot	SM, 9/125, OM2	010 = 1.0m (XXX)	020 = 2.0m (XXX)	030 = 3.0m (XXX)	050 = 5.0m (XXX)

SC to LC

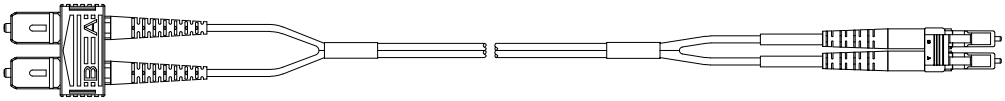

Bel Part Number	Description	Type	Lengths Available (XXX)			
SCLC-6DTPXXX	SC to SC, Orange Cable with Beige Boot	MM, 62.5/125, OM1	010 = 1.0m (XXX)	020 = 2.0m (XXX)	030 = 3.0m (XXX)	050 = 5.0m (XXX)
SCLC-3DTPXXX	SC to LC, Aqua Cable with Aqua Boot	MM, 50/125, OM3	010 = 1.0m (XXX)	020 = 2.0m (XXX)	030 = 3.0m (XXX)	050 = 5.0m (XXX)
SCLC-SDTPXXX	SC to LC, Yellow Cable with Blue Boot	SM, 9/125, OM2	010 = 1.0m (XXX)	020 = 2.0m (XXX)	030 = 3.0m (XXX)	050 = 5.0m (XXX)

SC to SC

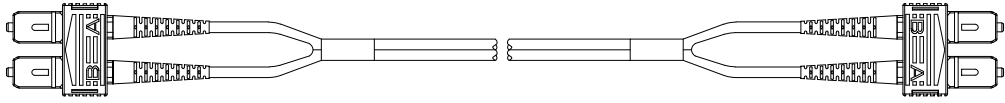

Bel Part Number	Description	Type	Lengths Available (XXX)			
SCSC-6DTPXXX	SC to SC, Orange Cable with Beige Boot	MM, 62.5/125, OM1	010 = 1.0m (XXX)	020 = 2.0m (XXX)	030 = 3.0m (XXX)	050 = 5.0m (XXX)
SCSC-SDTPXXX	SC to SC, Yellow Cable with Blue Boot	SM, 9/125, OM2	010 = 1.0m (XXX)	020 = 2.0m (XXX)	030 = 3.0m (XXX)	050 = 5.0m (XXX)

ST to ST

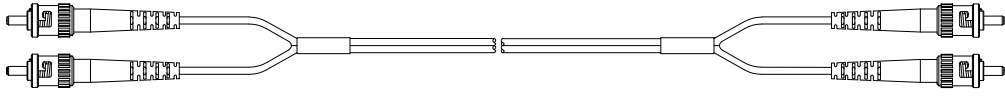

Bel Part Number	Description	Type	Lengths Available (XXX)			
STST-6DTPXXX	ST to ST, Orange Cable with Beige Boot	MM, 62.5/125, OM1	010 = 1.0m (XXX)	020 = 2.0m (XXX)	030 = 3.0m (XXX)	050 = 5.0m (XXX)

Straight and Reverse Modular Cable Assemblies

Description

Bel's modular cable offering also includes straight and reverse modular cable assemblies. RJ11, RJ12 and RJ45 configurations offer solutions for data and voice applications where high data transmission rates are not required. Straight through wiring modular cable assemblies are commonly used for connections between modems, fax machines, or other data applications. Reverse wiring cable assemblies are often used for voice applications. Bel's straight and reverse wired modular cable assemblies include 28 AWG conductors and gold-plated contacts to provide clear transmission.

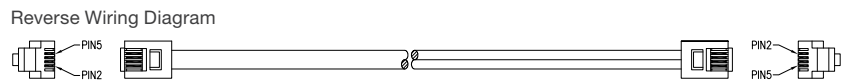
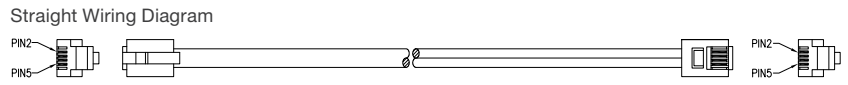

RJ11 Modular Cable Assemblies

Bel Part Number	Positions/Contacts	Straight/Reverse	Color	Lengths Available (XXX)		
BC-64SSXXXF	6 position 4 contact	Straight	Silver	007 = 7ft (XXX)	014 = 14ft (XXX)	025 = 25ft (XXX)
BC-64RSXXXF	6 position 4 contact	Reverse	Silver	007 = 7ft (XXX)	014 = 14ft (XXX)	025 = 25ft (XXX)

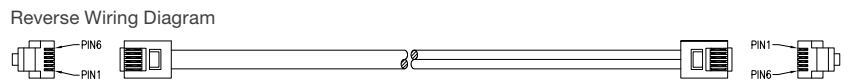
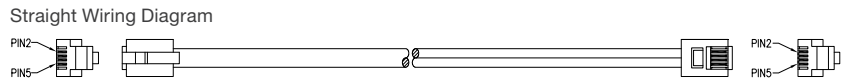

RJ12 Modular Cable Assemblies

Bel Part Number	Positions/Contacts	Straight/Reverse	Color	Lengths Available (XXX)		
BC-66SSXXXF	6 position 6 contact	Straight	Silver	007 = 7ft (XXX)	014 = 14ft (XXX)	025 = 25ft (XXX)
BC-66RSXXXF	6 position 6 contact	Reverse	Silver	007 = 7ft (XXX)	014 = 14ft (XXX)	025 = 25ft (XXX)

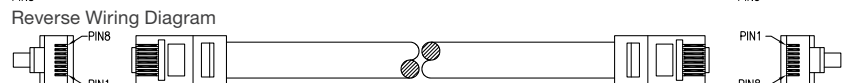
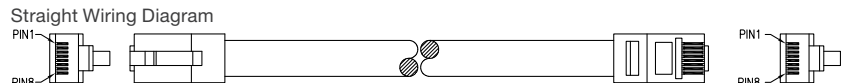

RJ45 Modular Cable Assemblies

Bel Part Number	Positions/Contacts	Straight/Reverse	Color	Lengths Available (XXX)
BC-88SS007F	8 position 8 contact	Straight	Silver	7ft
BC-88RS007F	8 position 8 contact	Reverse	Silver	7ft

BC 6 4 S S XXX F

Part Number

BC = Cable Assembly Family

Position

6 = 6 Position
8 = 8 Position

Contacts

4 = 4 Contacts
6 = 6 Contacts
8 = 8 Contacts

UOM

F = Feet

Length

007F = 7ft **014F** = 14ft **025F** = 25ft

Color

S = Silver

Straight/Reverse

S = Straight
R = Reverse

HDMI Cable Assemblies

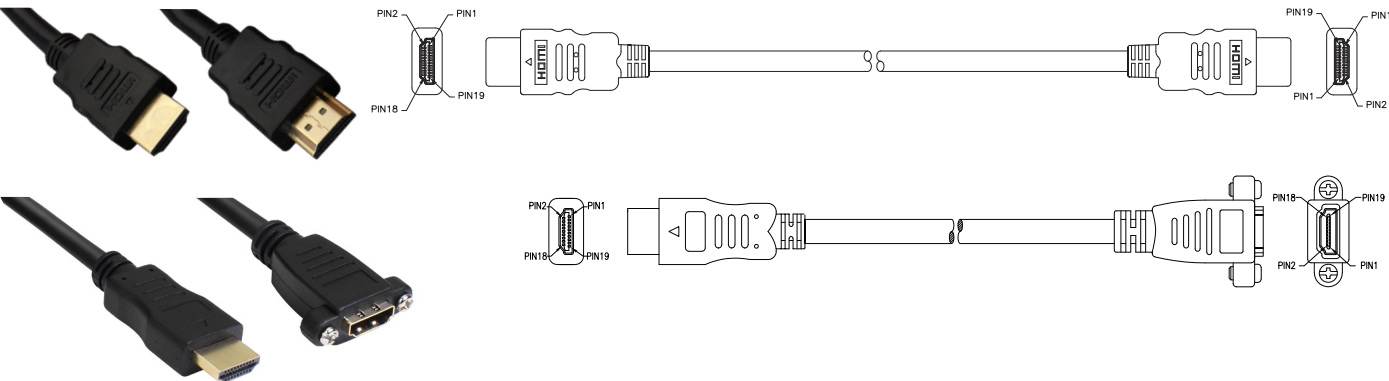

Description

Bel's HDMI cable assemblies support standard enhanced or high-definition video plus multi-channel audio on a single cable. HDMI technology is an industry-supported, evolving standard that combines video and audio into a single digital interface used in many audio-visual technologies including televisions, screens and displays for IoT applications. The HDMI cable assemblies feature gold-plated connectors to provide superior transmission, high reliability, and durability. The HDMI male to female assemblies features a panel mount design to provide a secured HDMI connection on faceplates or panels. Bel's HDMI assemblies are backwards compatible with previous HDMI standards.

HDMI Male to Male Assemblies

Bel Part Number	End Connector A	End Connector B	Performance	Lengths Available		AWG Size
				ft	m	
BC-HH003F	HDMI Male	HDMI Male	HDMI 2.0	3ft	0.91m	28 AWG
BC-HH006F	HDMI Male	HDMI Male	HDMI 2.0	6ft	1.82m	28 AWG
BC-HH010F	HDMI Male	HDMI Male	HDMI 2.0	10ft	3.04m	28 AWG

HDMI Male to Female Panel Mount Assemblies

Bel Part Number	End Connector A	End Connector B	Performance	Lengths Available		AWG Size
				ft	m	
BC-HF001F	HDMI Male	HDMI Female Panel Mount	HDMI 1.4	1ft	0.30m	28 AWG
BC-HF003F	HDMI Male	HDMI Female Panel Mount	HDMI 1.4	3ft	0.91m	28 AWG
BC-HF006F	HDMI Male	HDMI Female Panel Mount	HDMI 1.4	6ft	1.82m	28 AWG
BC-HF010F	HDMI Male	HDMI Female Panel Mount	HDMI 1.4	10ft	3.04m	28 AWG

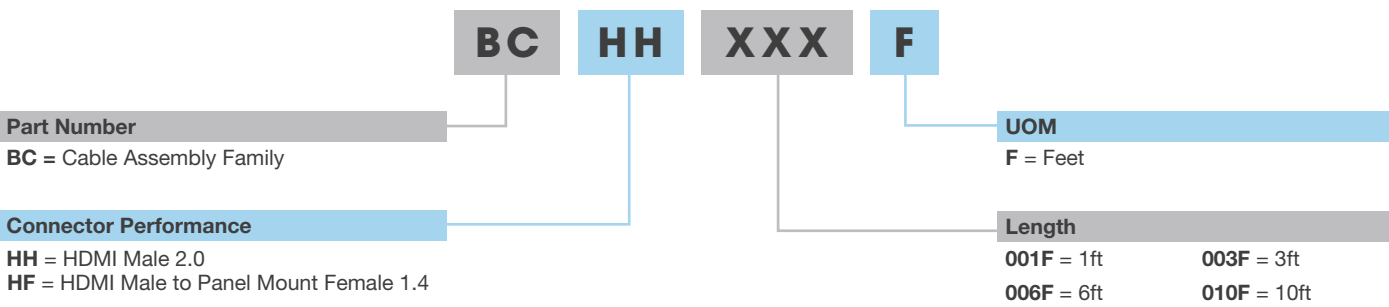

DisplayPort Cable Assemblies



Description

Bel's DisplayPort cable assembly line offers a variety of options for digital audio and video transmissions between computer systems and display systems such as computer monitors or projectors. Each product in the DisplayPort product line features gold-plated connectors which decrease the possibility of corrosion, improves signal transmissions, and provides durability. The DisplayPort product line supports a variety of DisplayPort specifications (DisplayPort 1.4, 1.2a, 1.2 and 1.1).

Bel Part Number	Connector End A	Connector End B	Lengths Available		AWG Size
			ft	m	
BC-DD003F	DisplayPort Male (DisplayPort 1.2)	DisplayPort Male (DisplayPort 1.2)	3ft	0.91m	28 AWG
BC-DD006F	DisplayPort Male (DisplayPort 1.2)	DisplayPort Male (DisplayPort 1.2)	6ft	1.82m	28 AWG
BC-DD0010	DisplayPort Male (DisplayPort 1.2)	DisplayPort Male (DisplayPort 1.2)	10ft	3.04m	28 AWG
BC-DH003F	DisplayPort Male (DisplayPort 1.2a Input)	HDMI Male (HDMI 1.4b Output)	3ft	0.91m	28 AWG
BC-DH006F	DisplayPort Male (DisplayPort 1.2a Input)	HDMI Male (HDMI 1.4b Output)	6ft	1.82m	28 AWG
BC-DH010F	DisplayPort Male (DisplayPort 1.2a Input)	HDMI Male (HDMI 1.4b Output)	10ft	3.04m	28 AWG
BC-DV003F	DisplayPort Male (DisplayPort 1.1 Input)	DVI Male (DVI 1.0 Output)	3ft	0.91m	28 AWG
BC-DV006F	DisplayPort Male (DisplayPort 1.1 Input)	DVI Male (DVI 1.0 Output)	6ft	1.82m	28 AWG
BC-DV010F	DisplayPort Male (DisplayPort 1.1 Input)	DVI Male (DVI 1.0 Output)	10ft	3.04m	28 AWG
BC-DM003F	DisplayPort Male (DisplayPort 1.1)	Mini DisplayPort Male (DisplayPort 1.1)	3ft	0.91m	32 AWG
BC-DM006F	DisplayPort Male (DisplayPort 1.1)	Mini DisplayPort Male (DisplayPort 1.1)	6ft	1.82m	32 AWG
BC-DM010F	DisplayPort Male (DisplayPort 1.1)	Mini DisplayPort Male (DisplayPort 1.1)	10ft	3.04m	32 AWG
BC-4D4D003F	DisplayPort Male (DisplayPort 1.4)	DisplayPort Male (DisplayPort 1.4)	3ft	0.91m	32 AWG
BC-4D4D006F	DisplayPort Male (DisplayPort 1.4)	DisplayPort Male (DisplayPort 1.4)	6ft	1.82m	30 AWG
BC-4D4D010F	DisplayPort Male (DisplayPort 1.4)	DisplayPort Male (DisplayPort 1.4)	10ft	3.04m	27 AWG
BC-4D4D015F	DisplayPort Male (DisplayPort 1.4)	DisplayPort Male (DisplayPort 1.4)	15ft	4.58m	26 AWG

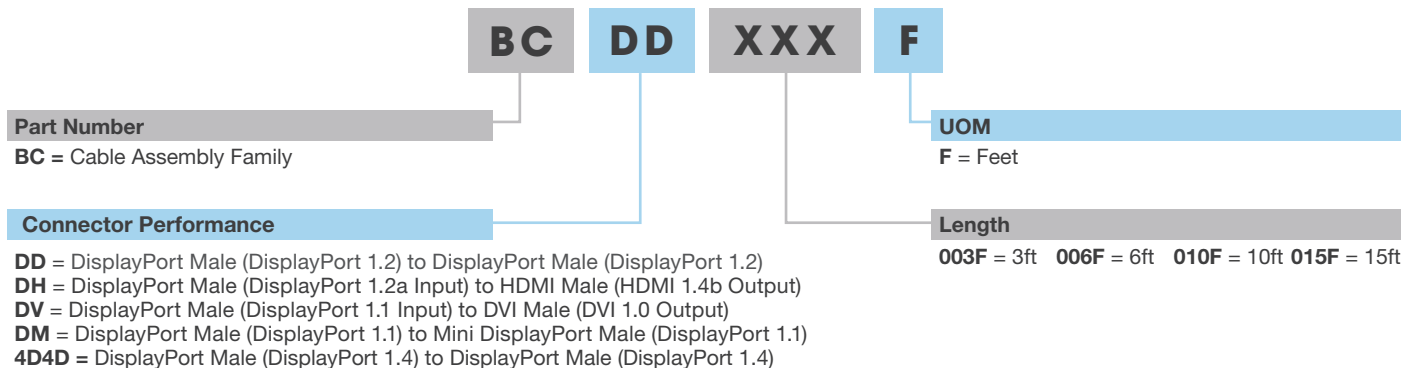

M12 X-Code Cable Assemblies

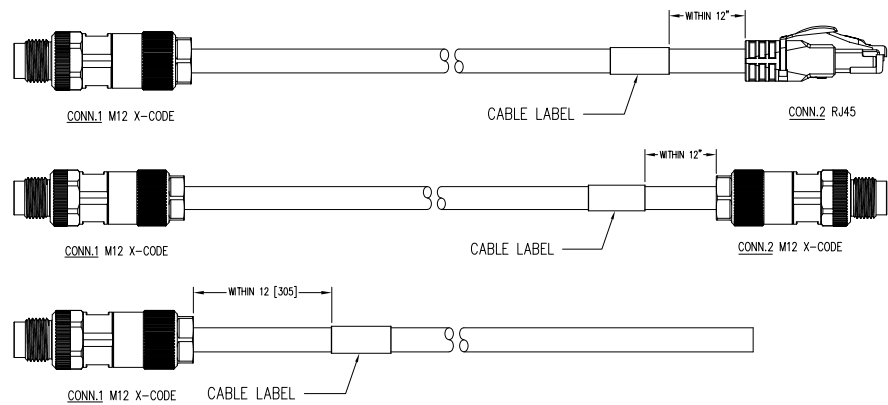

Description

Bel's M12 X-Code cable assemblies are available in both M12 X-Code male to M12 X-Code male and M12 X-Code male to an over molded RJ45 male plug. M12 X-Code cable assemblies provide reliable connections with a high performance in industrial environments for Modbus, Ethernet, PROFINET and EtherCAT. These cable assemblies are made with TPE cable jacket to add to their robust nature. Bel offers both Cat 5e and Cat 6a performance options that can deliver up to 10 gigabit Ethernet. These cable assemblies allow for quick and reliable connections in industrial environments.

Bel Part Number	Category	Connector End A	Connector End B	Lengths Available	
				ft	m
BM-MARM003F	Cat 6a	Shielded, Over molded RJ45	M12 X-Code Male Plug	3ft	0.91m
BM-MARM005F	Cat 6a	Shielded, Over molded RJ45	M12 X-Code Male Plug	5ft	1.52m
BM-MARM007F	Cat 6a	Shielded, Over molded RJ45	M12 X-Code Male Plug	7ft	2.13m
BM-MARM010F	Cat 6a	Shielded, Over molded RJ45	Shielded, Over molded RJ45	10ft	3.04m
BM-MARM015F	Cat 6a	Shielded, Over molded RJ45	M12 X-Code Male Plug	15ft	4.57m
BM-MARM030F	Cat 6a	Shielded, Over molded RJ45	M12 X-Code Male Plug	30ft	9.14m
BM-MARM010M	Cat 6a	Shielded, Over molded RJ45	M12 X-Code Male Plug	3.28ft	1m
BM-MARM020M	Cat 6a	Shielded, Over molded RJ45	M12 X-Code Male Plug	6.56ft	2m
BM-MARM030M	Cat 6a	Shielded, Over molded RJ45	M12 X-Code Male Plug	9.84ft	3m
BM-MARM050M	Cat 6a	Shielded, Over molded RJ45	M12 X-Code Male Plug	16.40ft	5m
BM-MARM100M	Cat 6a	Shielded, Over molded RJ45	M12 X-Code Male Plug	32.80ft	10m
BM-MBRM003F	Cat 5e	Shielded, Over molded RJ45	M12 X-Code Male Plug	3ft	0.91m
BM-MBRM005F	Cat 5e	Shielded, Over molded RJ45	M12 X-Code Male Plug	5ft	1.52m
BM-MBRM007F	Cat 5e	Shielded, Over molded RJ45	M12 X-Code Male Plug	7ft	2.13m
BM-MBRM010F	Cat 5e	Shielded, Over molded RJ45	M12 X-Code Male Plug	10ft	3.04m
BM-MBRM010M	Cat 5e	Shielded, Over molded RJ45	M12 X-Code Male Plug	3.28ft	1m
BM-MBRM020M	Cat 5e	Shielded, Over molded RJ45	M12 X-Code Male Plug	6.56ft	2m
BM-MBRM030M	Cat 5e	Shielded, Over molded RJ45	M12 X-Code Male Plug	9.84ft	3m
BM-MBRM050M	Cat 5e	Shielded, Over molded RJ45	M12 X-Code Male Plug	16.40ft	5m
BM-MBRM100M	Cat 5e	Shielded, Over molded RJ45	M12 X-Code Male Plug	32.80ft	10m
BM-MAMM003F	Cat 6a	M12 X-Code Male Plug	M12 X-Code Male Plug	3ft	0.91m
BM-MAMM005F	Cat 6a	M12 X-Code Male Plug	M12 X-Code Male Plug	5ft	1.52m



M12 X-Code Cable Assemblies

Bel Part Number	Category	Connector End A	Connector End B	Lengths Available	
				ft	m
BM-MAMM007F	Cat 6a	M12 X-Code Male Plug	M12 X-Code Male Plug	7ft	2.13m
BM-MAMM010F	Cat 6a	M12 X-Code Male Plug	M12 X-Code Male Plug	10ft	3.04m
BM-MAMM015F	Cat 6a	M12 X-Code Male Plug	M12 X-Code Male Plug	15ft	4.57m
BM-MAMM030F	Cat 6a	M12 X-Code Male Plug	M12 X-Code Male Plug	30ft	9.14m
BM-MAMM010M	Cat 6a	M12 X-Code Male Plug	M12 X-Code Male Plug	3.28ft	1m
BM-MAMM020M	Cat 6a	M12 X-Code Male Plug	M12 X-Code Male Plug	6.56ft	2m
BM-MAMM030M	Cat 6a	M12 X-Code Male Plug	M12 X-Code Male Plug	9.84ft	3m
BM-MAMM050M	Cat 6a	M12 X-Code Male Plug	M12 X-Code Male Plug	16.40ft	5m
BM-MAMM100M	Cat 6a	M12 X-Code Male Plug	M12 X-Code Male Plug	32.80ft	10m
BM-MBMM003F	Cat 5e	M12 X-Code Male Plug	M12 X-Code Male Plug	3ft	0.91m
BM-MBMM005F	Cat 5e	M12 X-Code Male Plug	M12 X-Code Male Plug	5ft	1.52m
BM-MBMM007F	Cat 5e	M12 X-Code Male Plug	M12 X-Code Male Plug	7ft	2.13m
BM-MBMM010F	Cat 5e	M12 X-Code Male Plug	M12 X-Code Male Plug	10ft	3.04m
BM-MBMM010M	Cat 5e	M12 X-Code Male Plug	M12 X-Code Male Plug	3.28ft	1m
BM-MBMM020M	Cat 5e	M12 X-Code Male Plug	M12 X-Code Male Plug	6.56ft	2m
BM-MBMM030M	Cat 5e	M12 X-Code Male Plug	M12 X-Code Male Plug	9.84ft	3m
BM-MBMM050M	Cat 5e	M12 X-Code Male Plug	M12 X-Code Male Plug	16.40ft	5m
BM-MBMM100M	Cat 5e	M12 X-Code Male Plug	M12 X-Code Male Plug	32.80ft	10m
BM-MAMD010M	Cat 6a	M12 X-Code Male Plug	Free End	3.28FT	1m
BM-MAMD020M	Cat 6a	M12 X-Code Male Plug	Free End	6.56FT	2m
BM-MAMD050M	Cat 6a	M12 X-Code Male Plug	Free End	16.40FT	5m
BM-MAMD100M	Cat 6a	M12 X-Code Male Plug	Free End	32.8FT	10m

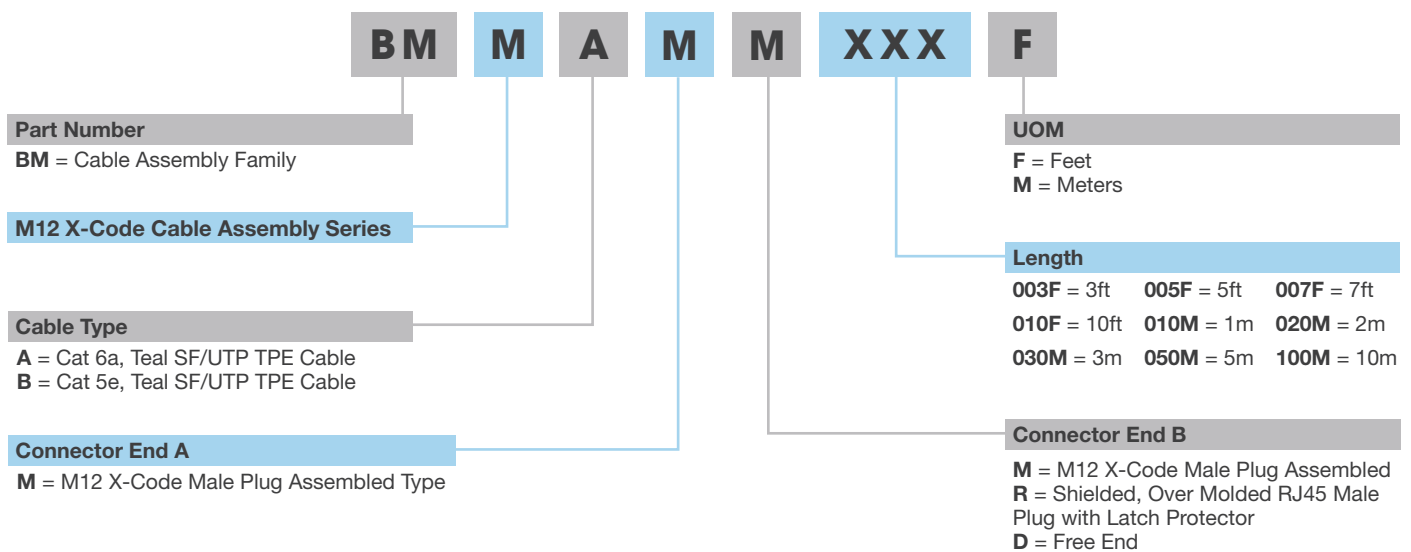

DVI Cable Assemblies



Description

Bel's DVI video cables series offers solutions for digital and analog signal transmissions. All configurations are compatible with projectors, TVs and other DVI enabled devices. Bel's DVI-D assemblies support digital signal and the DVI-I cable assemblies support both analog and digital signals. Bel's DVI video cables include gold-plated connectors to provide durable and reliable transmissions. The DVI Single link video cables support transmissions up to 4.95 Gbps and the DVI Dual link video cables support transmissions up to 9.9 Gbps.

DVI-D Single Link (18+1)

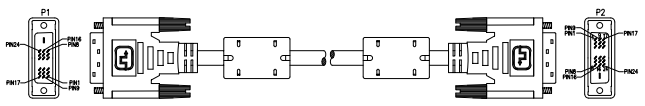

Bel Part Number	Description	Color	Resolution Supported	Lengths Available	
				ft	m
BC-VDSK010M	DVI-D Single Link (18 +1) to DVI-D Single Link (18+1)	Black	1280 x 720	3.28ft	1m
BC-VDSK020M	DVI-D Single Link (18 +1) to DVI-D Single Link (18+1)	Black	1280 x 720	9.84ft	2m

DVI-D Dual Link (24+1)

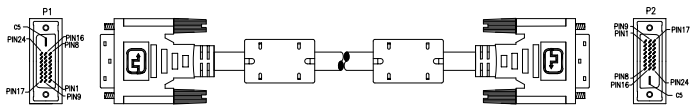

Bel Part Number	Description	Color	Resolution Supported	Lengths Available	
				ft	m
BC-VDDK010M	DVI-D Dual Link (24+1) to DVI-D Dual Link (24+1)	Black	2560 x 1600	3.28ft	1m
BC-VDDK020M	DVI-D Dual Link (24+1) to DVI-D Dual Link (24+1)	Black	2560 x 1600	9.84ft	2m

DVI-I Dual Link (24+5)

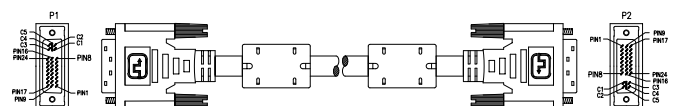

Bel Part Number	Description	Color	Resolution Supported	Lengths Available	
				ft	m
BC-VIDK010M	DVI-I Dual Link (24+5) to DVI-I Dual Link (24+5)	Black	2560 x 1600	3.28ft	1m
BC-VIDK020M	DVI-I Dual Link (24+5) to DVI-I Dual Link (24+5)	Black	2560 x 1600	9.84ft	2m

BC
V
D
S
K
XXX
M

Part Number
BC = Cable Assembly Family

Connector Performance
V = DVI Cable Assembly

Type
D = DVI-D Cable Assembly
I = DVI-I Cable Assembly

Link
S = Single Link
D = Dual Link

UOM
F = Feet

Length
010M = 1m 020M = 2m

Color
K = Black

USB Type-C Adapter Cable Assemblies



Description

Bel's USB Type-C adapter cable assemblies enable connections to a USB Type-C equipped computer or smartphone directly to an HD monitor, TV, or projector with several input options. These cable assemblies are only for use with USB-C connected devices that support DP Alt Mode or Thunderbolt™3 connectors. These cable assemblies feature gold-plated connectors to provide superior transmission, high reliability, and durability. USB Type-C supports USB 3.1 communications and features in a small, reversible connector that allows quick and easy plug in. The USB Type-C adapter cable assemblies include HDMI, DisplayPort, and VGA options and are unidirectional (USB Type-C connector input, HDMI, DisplayPort, or VGA output). HDMI and DisplayPort options support output resolutions up to 4K x 2K@60HZ. The VGA option supports output resolutions up to 1920 x 1200@60HZ.

Bel Part Number	Connector End A	Connector End B	Lengths Available	
			ft	m
BC-DC003F	DisplayPort (Male)	USB Type-C (Male)	3ft	0.91m
BC-DC006F	DisplayPort (Male)	USB Type-C (Male)	6ft	1.82m
BC-DC010F	DisplayPort (Male)	USB Type-C (Male)	10ft	3.04m
BC-HC003F	HDMI (Male)	USB Type-C (Male)	3ft	0.91m
BC-HC006F	HDMI (Male)	USB Type-C (Male)	6ft	1.82m
BC-HC010F	HDMI (Male)	USB Type-C (Male)	10ft	3.04m
BC-VC003F	VGA (Male)	USB Type-C (Male)	3ft	0.91m
BC-VC006F	VGA (Male)	USB Type-C (Male)	6ft	1.82m
BC-VC010F	VGA (Male)	USB Type-C (Male)	10ft	3.04m

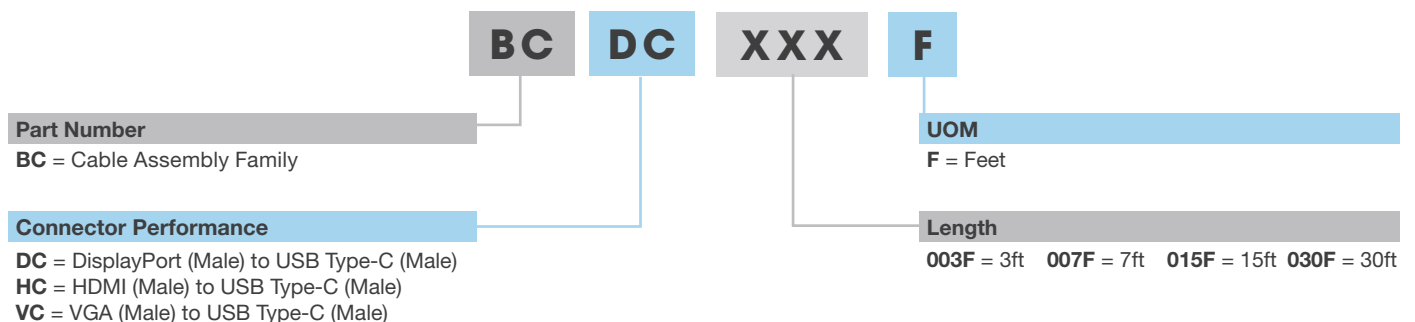

IP67 USB Cable Assemblies



Description

Stewart Connector’s IP67 USB Type-A cable assemblies are ideal for harsh environments and industrial applications. These cable assemblies are IP67 rated with configurations available with both USB 2.0 and USB 3.0 speeds. IP67 ends are equipped with threaded receptacles to ensure quick and correct mating connections. The IP67 USB Type-A cable assemblies can be used in multiple applications, including industrial automation, medical devices, military applications, and other harsh environments.

Part Number	Connector End A	Connector End B	USB Rating	Length	
				ft	m
67U2AC-003-K	IP67 USB 2.0 Type-A Male (Circular Coupling)	USB 2.0 Type-A Male	USB 2.0	3ft	0.910m
67U2AC-006-K	IP67 USB 2.0 Type-A Male (Circular Coupling)	USB 2.0 Type-A Male	USB 2.0	6ft	1.82m
67U2AD-006-K	IP67 USB 2.0 Type-A Male (Circular Coupling)	Free Cable End	USB 2.0	6ft	1.82m
67U2AA-006-K	IP67 USB 2.0 Type-A Male (Circular Coupling)	IP67 USB 2.0 Type-A Male (Circular Coupling)	USB 2.0	6ft	1.82m
67U3AA-006-K	IP67 USB 3.0 Type-A Male (Circular Coupling)	IP67 USB 3.0 Type-A Male (Circular Coupling)	USB 3.0	6ft	1.82m
67U3AD-006-K	IP67 USB 3.0 Type-A Male (Circular Coupling)	Free Cable End	USB 3.0	6ft	1.82m
67U3AC-006-K	IP67 USB 3.0 Type-A Male (Circular Coupling)	USB 3.0 Type-A Male	USB 3.0	6ft	1.82m
67U2BD-003-K	IP67 USB 2.0 Type-A Female (Circular Coupling)	Free Cable End	USB 2.0	3ft	0.910m
67U2BD-006-K	IP67 USB 2.0 Type-A Female (Circular Coupling)	Free Cable End	USB 2.0	6ft	1.82m
67U3BD-006-K	IP67 USB 3.0 Type-A Female (Circular Coupling)	Free Cable End	USB 2.0	6ft	1.82m
67U3BC-002-K	IP67 USB 3.0 Type-A Female (Circular Coupling)	USB 3.0 Type-A Male	USB 3.0	2ft	0.60m

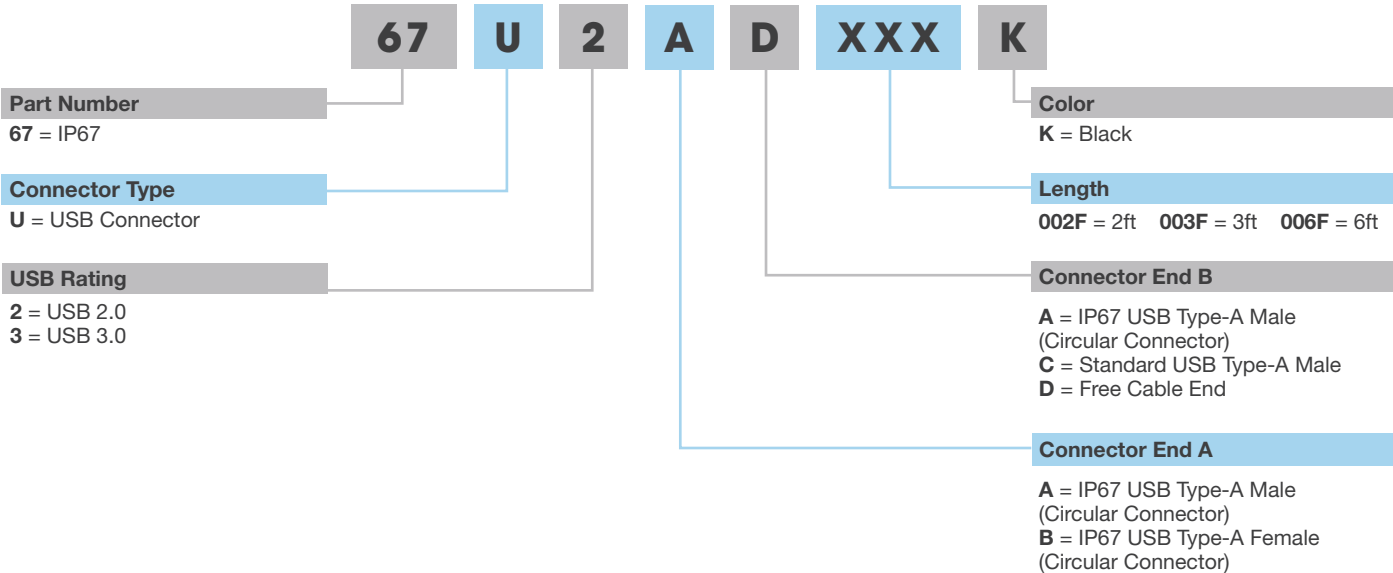

RJ45 Plug to RJ45 Jack Cable Assemblies



Description

Bel's RJ45 Plug to RJ45 Jack cable assemblies are ideal solutions for situations where Ethernet extension is needed to create Ethernet connections. These assemblies extend Ethernet connections that may be in hard-to-reach areas or need to be accessible outside of enclosures. Unshielded options are available in Cat 5e and Cat 6 performance speeds. The shielded options are available in a Cat 6a performance. All options are backwards compatible with lower performance levels.

Bel Part Number	Performance	Lengths Available		Cable Type	Cable Color
		ft	m		
BM-5AJPK001F	Cat 5e	1ft	0.30m	UTP Stranded CM	Black
BM-5AJPK003F	Cat 5e	3ft	0.91m	UTP Stranded CM	Black
BM-5AJPK005F	Cat 5e	5ft	1.52m	UTP Stranded CM	Black
BM-5AJPK007F	Cat 5e	7ft	2.13m	UTP Stranded CM	Black
BM-5AJPK010F	Cat 5e	10ft	3.04m	UTP Stranded CM	Black
BM-5AJPK015F	Cat 5e	15ft	4.57m	UTP Stranded CM	Black
BM-5AJPK025F	Cat 5e	25ft	7.62m	UTP Stranded CM	Black
BM-6AJPK001F	Cat 6	1ft	0.30m	UTP Stranded CM	Black
BM-6AJPK003F	Cat 6	3ft	0.91m	UTP Stranded CM	Black
BM-6AJPK005F	Cat 6	5ft	1.52m	UTP Stranded CM	Black
BM-6AJPK007F	Cat 6	7ft	2.13m	UTP Stranded CM	Black
BM-6AJPK010F	Cat 6	10ft	3.04m	UTP Stranded CM	Black
BM-6AJPK015F	Cat 6	15ft	4.57m	UTP Stranded CM	Black
BM-6AJPK025F	Cat 6	25ft	7.62m	UTP Stranded CM	Black
BM-1BJPK001F	Cat 6a	1ft	0.30m	FTP Stranded CM	Black
BM-1BJPK003F	Cat 6a	3ft	0.91m	FTP Stranded CM	Black
BM-1BJPK005F	Cat 6a	5ft	1.52m	FTP Stranded CM	Black
BM-1BJPK007F	Cat 6a	7ft	2.13m	FTP Stranded CM	Black
BM-1BJPK010F	Cat 6a	10ft	3.04m	FTP Stranded CM	Black
BM-1BJPK015F	Cat 6a	15ft	4.57m	FTP Stranded CM	Black
BM-1BJPK025F	Cat 6a	25ft	7.62m	FTP Stranded CM	Black

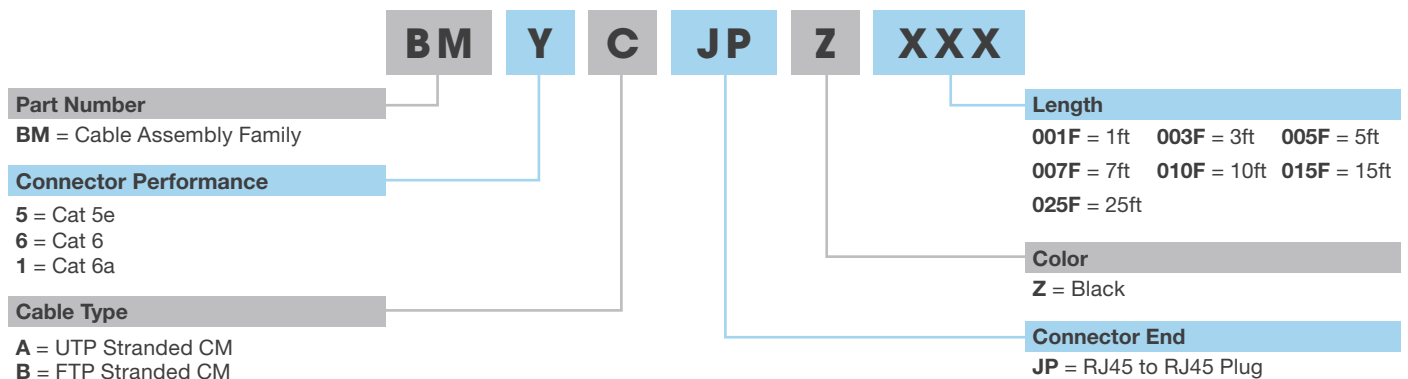

MPO Cable Assemblies

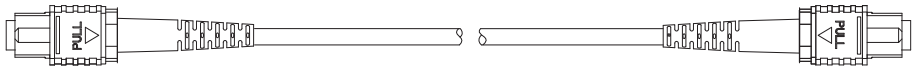

Description

Bel's MPO cables provide a high-density solution featuring a push-pull design for easy mating and removal. Each are composed of 12 strands of fiber in a single assembly featuring minimized end connectors for multiple connections while occupying little space. These cables are rated to 40 Gbps and are used to connect equipment that utilizes MPO style connectors and OM3 10 Gigabit 50/125 multimode cabling. MPO fiber assemblies are often used for QSFP transceivers, server farms, data centers and other IoT applications.

Part Number	Connector End A	Connector End B	Fiber Rating	Fiber Count	Length	
					ft	m
MFMF-3ATP010	MPO Female	MPO Female	MM 50/125 OM3	12	3.28ft	1m
MFMF-3ATP030	MPO Female	MPO Female	MM 50/125 OM3	12	9.84ft	3m
MFMF-3ATP050	MPO Female	MPO Female	MM 50/125 OM3	12	16.40ft	5m
MFMF-3ATP100	MPO Female	MPO Female	MM 50/125 OM3	12	32.50ft	10m

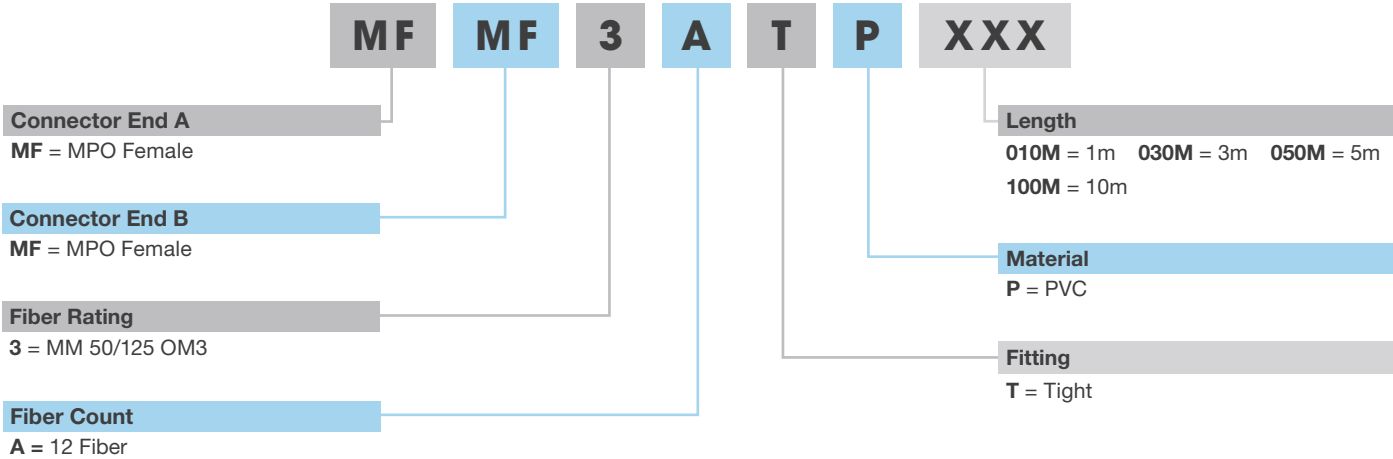

3.5mm Audio Cables

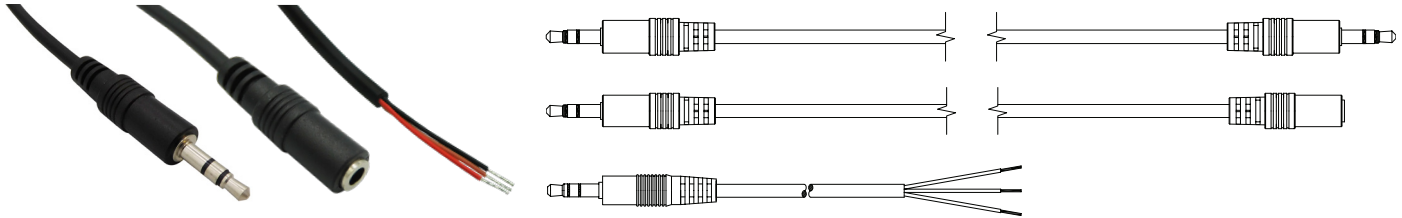

Description

Bel's 3.5mm audio cables offer connection solutions for audio devices with a 3.5mm connector. Bel's 3.5mm audio cables are compatible with smartphones, tablets, laptops, TVs, and other audio devices that are equipped with 3.5mm connectors. Bel offers 3.5mm male to male assemblies, 3.5mm male to female audio extension cables, and additionally 3.5mm male to a tinned lead free end. The 3.5mm audio extension cable is an ideal solution to both extend the length of a 3.5mm audio cable and protect 3.5mm AUX ports on audio devices from constant use. Bel's audio cables are assembled with RoHS compliant materials.

Bel Part Number	Connector End A	Connector End B	Lengths	
			ft	m
BC-A3MM003F	Male 3.5mm 3pin Stereo Plug	Male 3.5mm 3pin Stereo Plug	3ft	0.91m
BC-A3MM006F	Male 3.5mm 3pin Stereo Plug	Male 3.5mm 3pin Stereo Plug	6ft	1.82m
BC-A3MF006F	Male 3.5mm 3pin Stereo Plug	Female 3.5mm 3pin Stereo Plug	6ft	1.82m
BC-A3ML006F	Male 3.5mm 3pin Stereo Plug	Tinned Lead Free End	6ft	1.82m

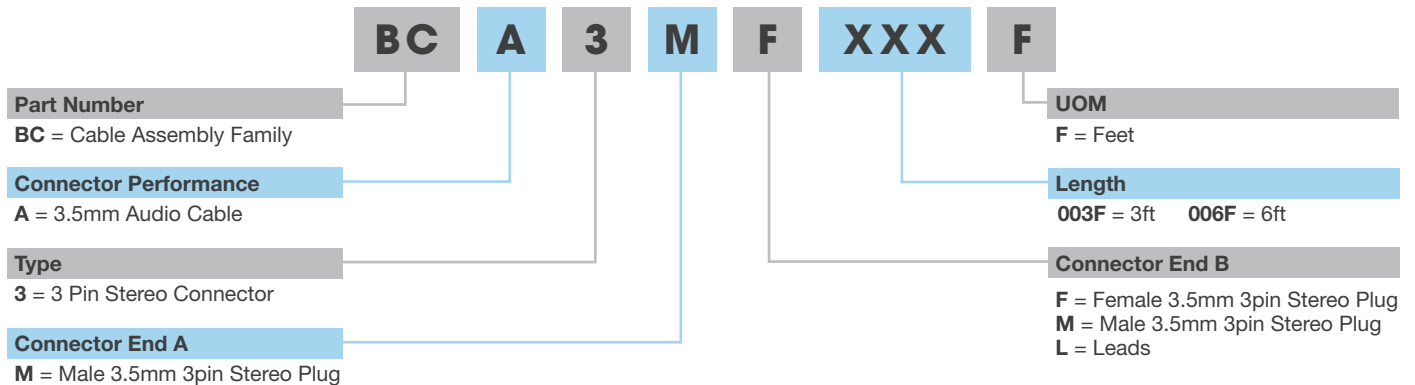

Power Cords

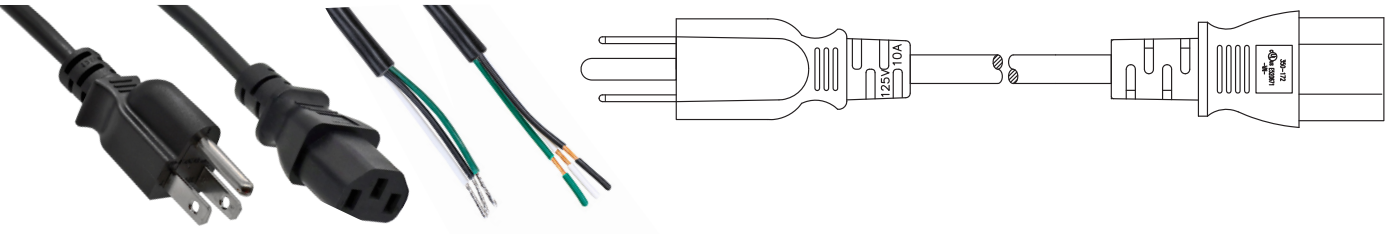

Description

Bel's power cords are an ideal solution for replacing damaged or missing power cords. They can be used for a variety of applications including office environments for connecting power to monitors, computers, scanners and other devices and appliances that have the IEC-60320-C13 inlet. Bel's 18 AWG standard power cord has a NEMA 5-15P to C13 inlet. For durability, these power cords are fully molded and UL listed.

Part Number	Connector End A	Connector End B	AWG Size	Length	
				ft	m
PC-ABK001F	NEMA 5-15P	IEC-60320-C13	18 AWG	1ft	0.304m
PC-ABK002F	NEMA 5-15P	IEC-60320-C13	18 AWG	2ft	0.609m
PC-ABK003F	NEMA 5-15P	IEC-60320-C13	18 AWG	3ft	0.914m
PC-ABK006F	NEMA 5-15P	IEC-60320-C13	18 AWG	6ft	1.83m
PC-ABK010F	NEMA 5-15P	IEC-60320-C13	18 AWG	10ft	3.05m
PC-ABK012F	NEMA 5-15P	IEC-60320-C13	18 AWG	12ft	3.65m
PC-ABK015F	NEMA 5-15P	IEC-60320-C13	18 AWG	15ft	4.57m
PC-ABK025F	NEMA 5-15P	IEC-60320-C13	18 AWG	25ft	7.62m
PC-ABK010M	NEMA 5-15P	IEC-60320-C13	18 AWG	3.28ft	1m
PC-ABK020M	NEMA 5-15P	IEC-60320-C13	18 AWG	6.56ft	2m
PC-ABK030M	NEMA 5-15P	IEC-60320-C13	18 AWG	9.84ft	3m
PC-ASLK010M	NEMA 5-15P	Blunt End	18 AWG	3.28ft	1m
PC-ASLK020M	NEMA 5-15P	Blunt End	18 AWG	6.56ft	2m
PC-ASLK030M	NEMA 5-15P	Blunt End	18 AWG	9.84ft	3m
PC-ATLK010M	NEMA 5-15P	Blunt End with Tinned Leads	18 AWG	3.28ft	1m
PC-ATLK020M	NEMA 5-15P	Blunt End with Tinned Leads	18 AWG	6.56ft	2m
PC-ATLK030M	NEMA 5-15P	Blunt End with Tinned Leads	18 AWG	9.84ft	3m

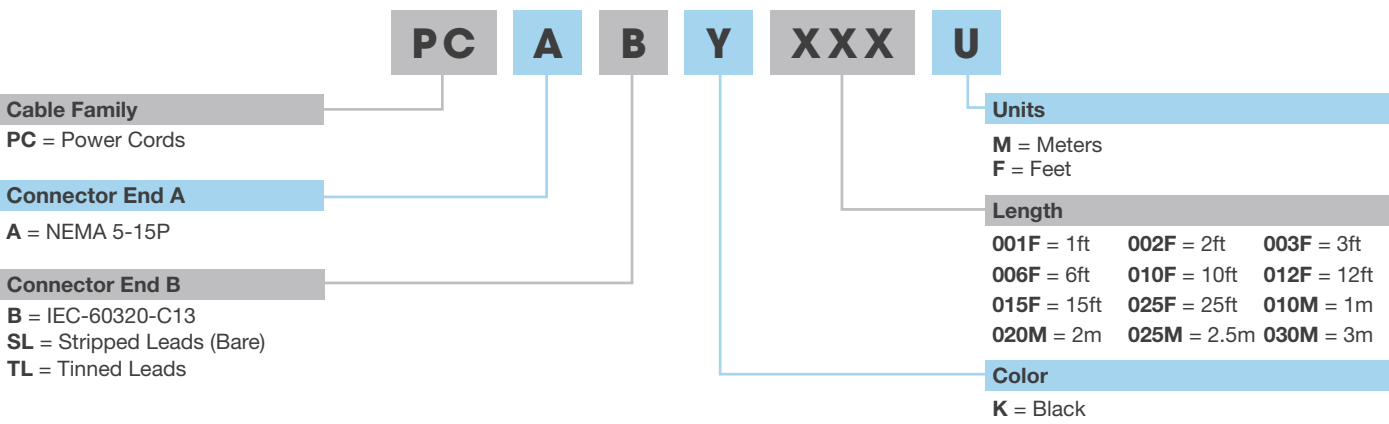

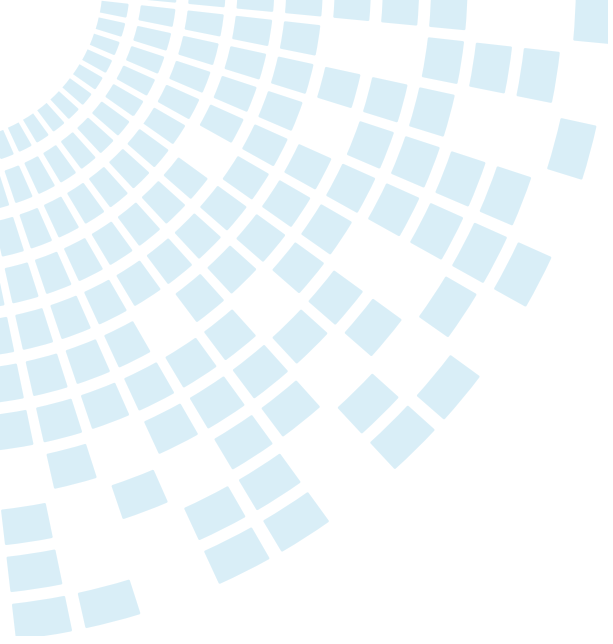

About Bel

Founded in 1949, Bel designs, manufactures and markets a broad array of products that power, protect and connect electronic circuits.

With over 65 years in the electronics industry, Bel has reliably demonstrated the ability to succeed in a variety of product areas across multiple industries. The company has a strong track record of technical innovation working with the engineering teams of market leaders.

Bel has consistently proven to be a valuable supplier to the foremost companies in its chosen industries by developing cost effective solutions for the challenges of new product development. By combining our strength in product design with our own specially designed manufacturing facilities, Bel has established itself as a formidable competitor on a global basis.



For more information, please contact us:

+1 717.235.7512
techhelp@belf.com
belfuse.com