

MFS

Sub-miniature Switches



RoHS Compliant



Common Specifications

Initial contact resistance

Measured at 1.5mA 200 μ VAC 1kHz

Dielectric strength

Measurement at 500 V AC.

Insulation Resistance

Measured at 500VDC

Operating temperature range

-10°C~+70°C

Part Numbering

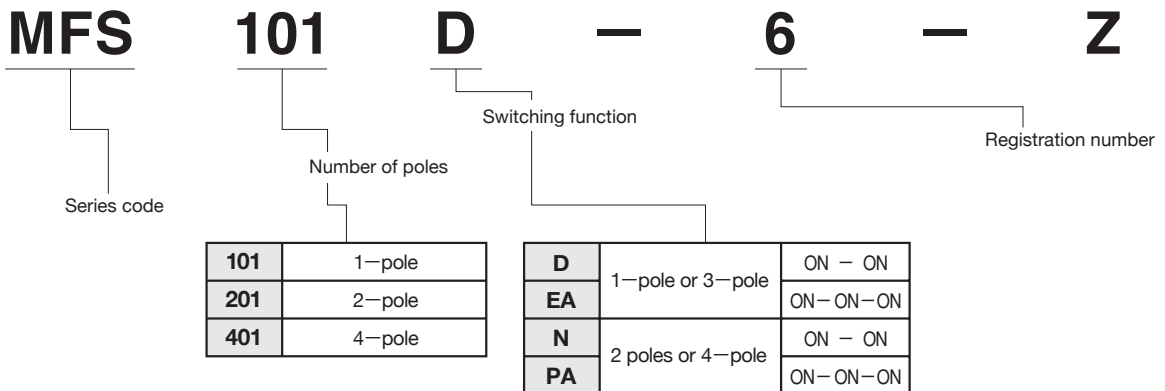

MFS101D-6-Z

Non-shorting

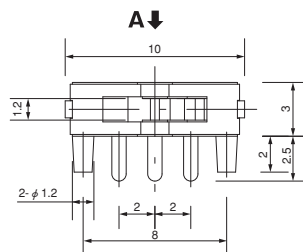
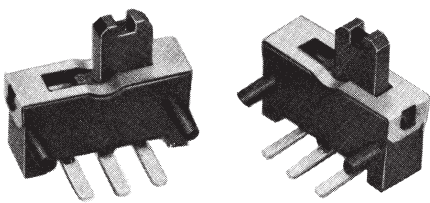

PC Hole Layouts

(Top view)

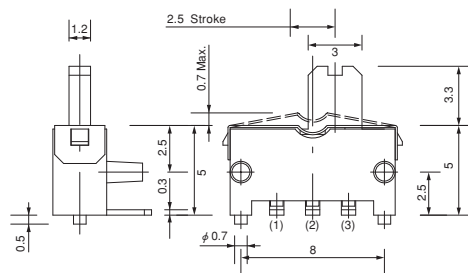
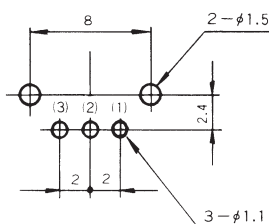

Specifications

Rating	Max.	DC10V 0.3A (Resistive load)
	Min.	DC5V 10mA (Resistive load)
Initial contact resistance	20m Ω Max.	
Dielectric strength	AC500V 1 minute	
Insulation resistance	100M Ω Min.	
Electrical life	5,000 cycles	
Operating force	0.98~2.94N	
Switch timing	Non-shorting	

Switching function (Viewed from A)	Circuit diagram	No. of terminals
ON		3
2-3		

Terminal numbers are not shown on the switch.

MFS

MFS101D-8-Z

shorting



PC Hole Layouts

(Top view)

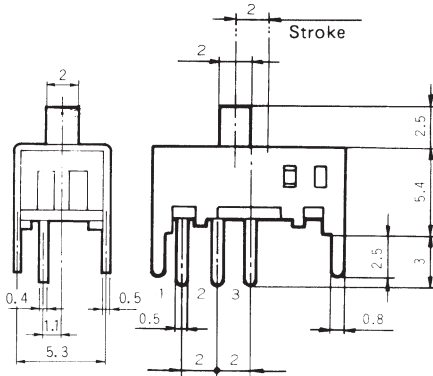
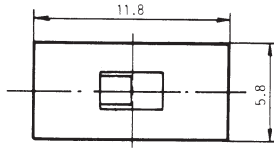
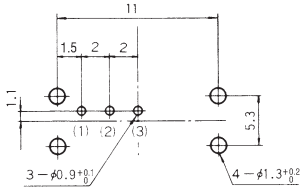

Terminal numbers are not shown on the switch.

Specifications

Rating	Max.	DC30V 0.3A AC30V 2A (Resistive load)
	Min.	DC5V 10mA (Resistive load)
Initial contact resistance	20m Ω Max.	
Dielectric strength	AC500V 1 minute	
Insulation resistance	100M Ω Min.	
Electrical life	5,000 cycles at DC30V 0.3A 100cycles at AC30V 2A	
Operating force	2.45 \pm 0.98 N	
Switch timing	Shorting	

Switching function (Viewed from A)	Circuit diagram	No. of terminals
		3
ON	ON	
2-1	2-3	

MFS101D-9-Z

Non-shorting

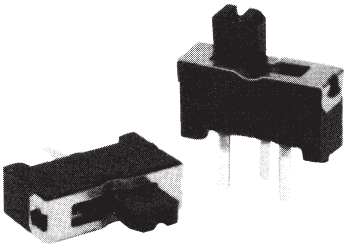

PC Hole Layouts

(Top view)

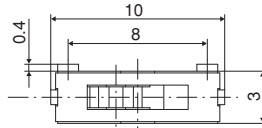
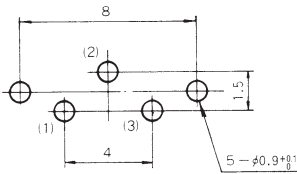

A ↑

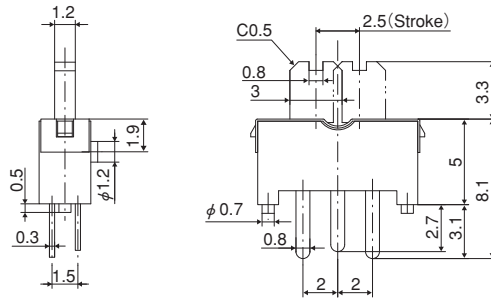

Terminal numbers are not shown on the switch.

Specifications

Rating	Max.	DC12V 0.3A (Resistive load)
	Min.	DC5V 10mA (Resistive load)
Initial contact resistance	20m Ω Max.	
Dielectric strength	AC500V 1 minute	
Insulation resistance	100M Ω Min.	
Electrical life	5,000 cycles	
Operating force	0.98 \pm 2.94N	
Switch timing	Non-shorting	

Switching function (Viewed from A)	Circuit diagram	No. of terminals
		3
ON	ON	
2-1	2-3	

☆ MFS101D-10-Z

Non-shorting

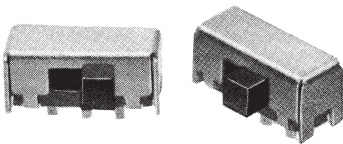

PC Hole Layouts

(Top view)

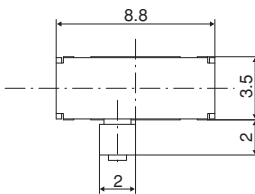
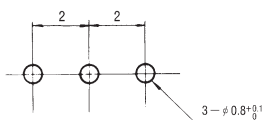

A ↓

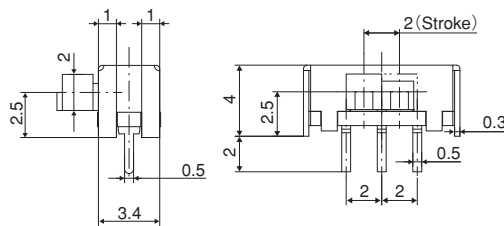

Terminal numbers are not shown on the switch.

Specifications

Rating	Max.	DC30V 0.3A (Resistive load)
	Min.	DC5V 10mA (Resistive load)
Initial contact resistance	20m Ω Max.	
Dielectric strength	AC500V 1 minute	
Insulation resistance	100M Ω Min.	
Electrical life	5,000 cycles	
Operating force	2.94 \pm 1.96N	
Switch timing	Non-shorting	

Switching function (Viewed from A)	Circuit diagram	No. of terminals
		3
2-3	2-1	

MFS

MFS101D-14-Z

Non-shorting



Panel Cut-Out Dimensions

(Top view)

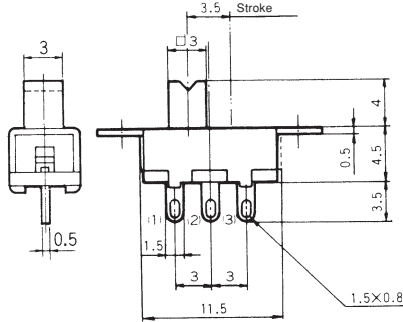
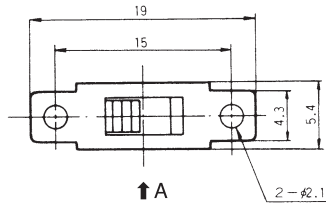
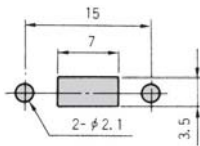

Terminal numbers are not shown on the switch.

Specifications

Rating	Max.	DC30V 0.3A (Resistive load)
	Min.	DC5V 10mA (Resistive load)
Initial contact resistance	20mΩ Max.	
Dielectric strength	AC500V 1 minute	
Insulation resistance	100MΩ Min.	
Electrical life	5,000 cycles	
Operating force	1.96±0.98N	
Switch timing	Non-shorting	

Switching function (Viewed from A)		Circuit diagram	No. of terminals
2-1	2-3		

MFS101D-15-Z

Non-shorting

Gold plated contact



PC Hole Layouts

(Top view)

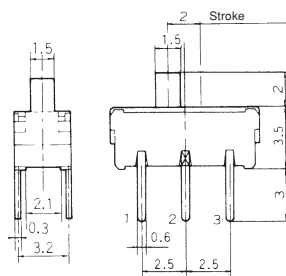
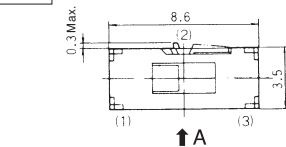
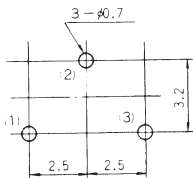

Terminal numbers are not shown on the switch.

Specifications

Rating	Max.	DC12V 0.2A (Resistive load)
	Min.	DC5V 10mA (Resistive load)
Initial contact resistance	50mΩ Max.	
Dielectric strength	AC500V 1 minute	
Insulation resistance	100MΩ Min.	
Electrical life	5,000 cycles	
Operating force	1.47±0.98N	
Switch timing	Non-shorting	

Switching function (Viewed from A)		Circuit diagram	No. of terminals
2-1	2-3		

MFS

☆MFS101EA-Z

※[Note] See below.

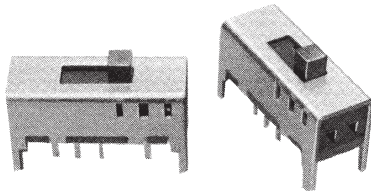

Specifications

Rating	Max.	DC30V 0.3A AC30V 2A (Resistive load)
	Min.	DC5V 10mA(Resistive load)
Initial contact resistance	20mΩ Max.	
Dielectric strength	AC500V 1 minute	
Insulation resistance	100MΩ Min.	
Electrical life	5,000 cycles at DC30V 0.3A 100cycles at AC30V 2A	
Operating force	$2.45 \pm 0.98N$ $1.47 \pm 0.98N$	
Switch timing	Undefined	

PC Hole Layouts

(Top view)

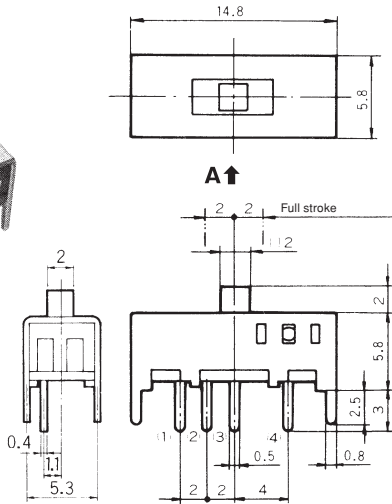
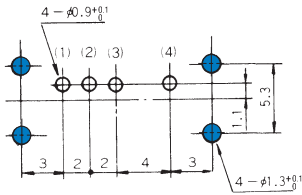

Terminal numbers are not shown on the switch.

Switching function (Viewed from A)			Circuit diagram	No. of terminals
				4
ON	ON	ON		
3-1	3-2	3-4		

: Operating force from the center to the outer side (right or left).
 : Operating force from the outer side (right or left) to the center.

MFS201N-Z

Non-shorting



Panel Cut-Out Dimensions

(Top view)

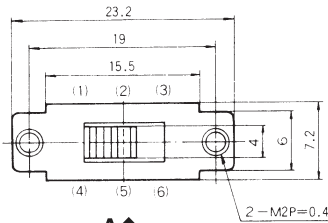
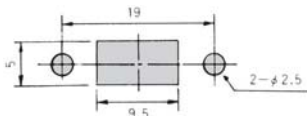

Terminal numbers are not shown on the switch.

Specifications

Rating	Max.	AC125V 1A · DC30V 1A
	Min.	DC5V 10mA(Resistive load)
Initial contact resistance	30mΩ Max.	
Dielectric strength	AC500V 1 minute	
Insulation resistance	300MΩ Min.	
Electrical life	5,000 cycles	
Operating force	0.98~4.9N	
Switch timing	Non-shorting	

Switching function (Viewed from A)		Circuit diagram	No. of terminals
			6
ON	ON		
2-1 5-4	2-3 5-6		

MFS201N-4-Z

Non-shorting

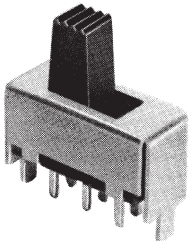

PC Hole Layouts

(Top view)

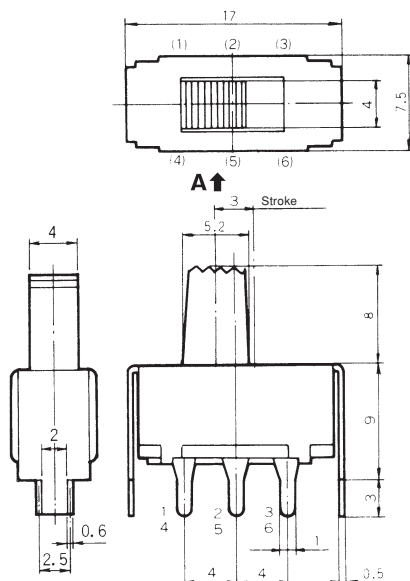
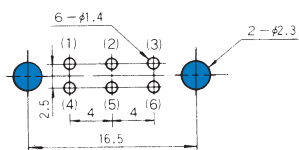

Terminal numbers are not shown on the switch.

Specifications

Rating	Max.	AC125V 1A · DC30V 1A
	Min.	DC5V 10mA(Resistive load)
Initial contact resistance	20mΩ Max.	
Dielectric strength	AC500V 1 minute	
Insulation resistance	300MΩ Min.	
Electrical life	5,000 cycles	
Operating force	1.47~4.41N	
Switch timing	Non-shorting	

Switching function (Viewed from A)		Circuit diagram	No. of terminals
			6
ON	ON		
2-1 5-4	2-3 5-6		

※ : Please note that MFS101EA-Z can be either Shorting or Non-shorting.

☆ : Semi-standard products.

MFS

MFS201N-9-Z

Non-shorting

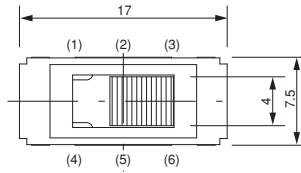
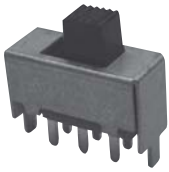

PC Hole Layouts

(Top view)

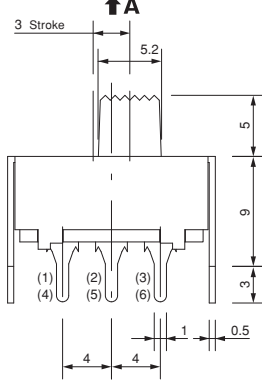
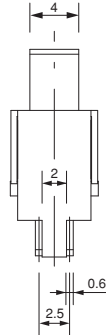
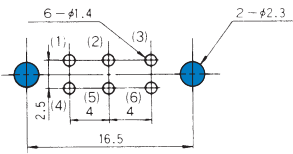

Terminal numbers are not shown on the switch.

Specifications

Rating	Max.	AC125V 1A · DC30V 1A
	Min.	DC5V 10mA (Resistive load)
Initial contact resistance	20mΩ Max.	
Dielectric strength	AC500V 1 minute	
Insulation resistance	300MΩ Min.	
Electrical life	5,000 cycles	
Operating force	1.47~4.41N	
Switch timing	Non-shorting	

Switching function (Viewed from A)		Circuit diagram	No. of terminals
2-1	2-3		
5-4	5-6		

MFS201N-16-Z

Non-shorting

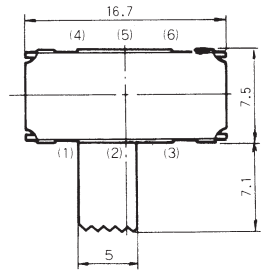

PC Hole Layouts

(Top view)

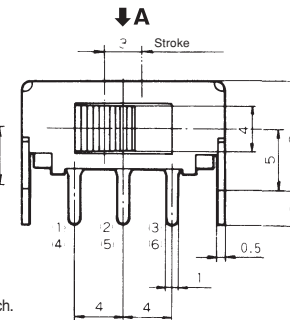
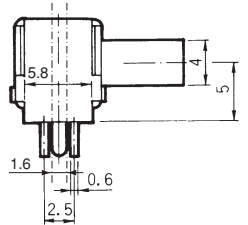
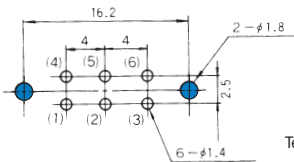

Terminal numbers are not shown on the switch.

Specifications

Rating	Max.	AC125V 1A · DC30V 1A
	Min.	DC5V 10mA (Resistive load)
Initial contact resistance	20mΩ Max.	
Dielectric strength	AC500V 1 minute	
Insulation resistance	100MΩ Min.	
Electrical life	5,000 cycles	
Operating force	2.94±1.47N	
Switch timing	Non-shorting	

Switching function (Viewed from A)		Circuit diagram	No. of terminals
2-3	2-1		
5-6	5-4		

MFS201N-19-Z

Shorting

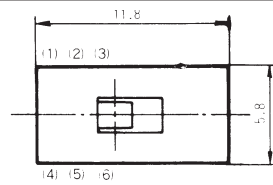

PC Hole Layouts

(Top view)

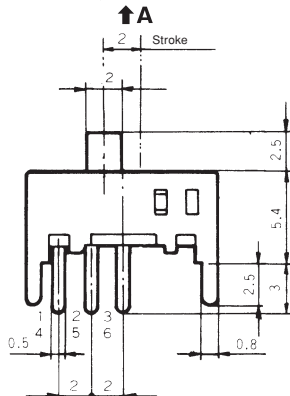
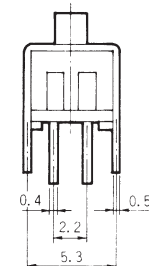
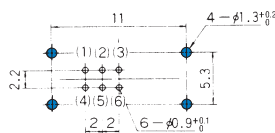

Terminal numbers are not shown on the switch.

Specifications

Rating	Max.	DC30V 0.3A (Resistive load)
	Min.	DC5V 10mA (Resistive load)
Initial contact resistance	20mΩ Max.	
Dielectric strength	AC500V 1 minute	
Insulation resistance	100MΩ Min.	
Electrical life	5,000 cycles	
Operating force	2.45±0.98N	
Switch timing	ショートティング Shorting	

Switching function (Viewed from A)		Circuit diagram	No. of terminals
2-1	2-3		
5-4	5-6		

MFS

★ MFS201N-20-Z

Shorting

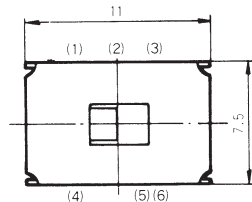
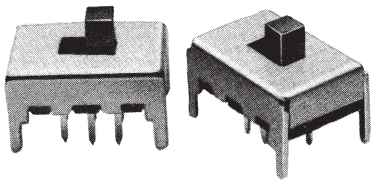

A ↑
Stroke

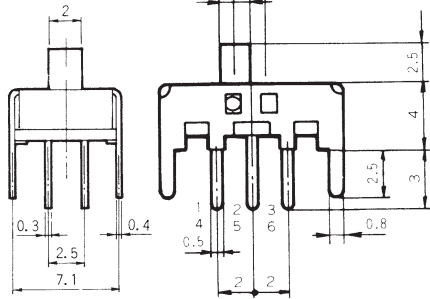

Terminal numbers are not shown on the switch.

PC Hole Layouts

(Top view)

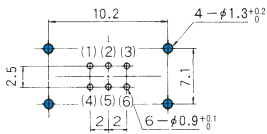

Specifications

Rating	Max.	DC30V 0.3A (Resistive load)
	Min.	DC5V 10mA (Resistive load)
Initial contact resistance	20mΩ Max.	
Dielectric strength	AC500V 1 minute	
Insulation resistance	100MΩ Min.	
Electrical life	5,000 cycles	
Operating force	4.41±1.47N	
Switch timing	Shorting	

Switching function (Viewed from A)		Circuit diagram	No. of terminals
			6
2-1	2-3		
5-4	5-6		

MFS201N-21-Z

Non-shorting

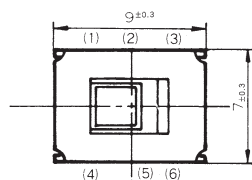

A ↑
Stroke

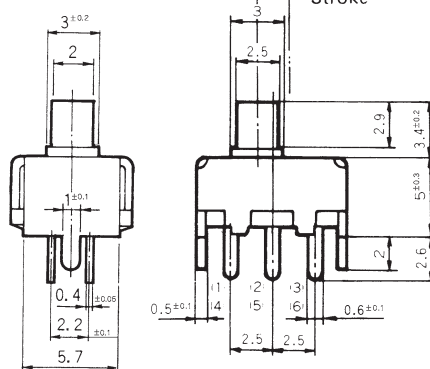

Terminal numbers are not shown on the switch.

PC Hole Layouts

(Top view)

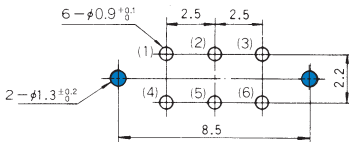

Specifications

Rating	Max.	DC30V 0.3A (Resistive load)
	Min.	DC5V 10mA (Resistive load)
Initial contact resistance	20mΩ Max.	
Dielectric strength	AC500V 1 minute	
Insulation resistance	100MΩ Min.	
Electrical life	5,000 cycles	
Operating force	2.45±0.98N	
Switch timing	Non-shorting	

Switching function (Viewed from A)		Circuit diagram	No. of terminals
			6
2-1	2-3		
5-4	5-6		

MFS

MFS201N-23-Z

Non-shorting

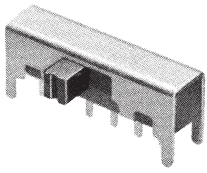

PC Hole Layouts

(Top view)

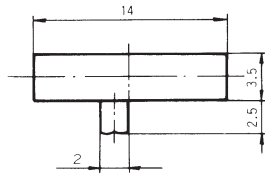
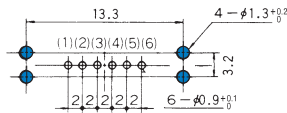

↓ A

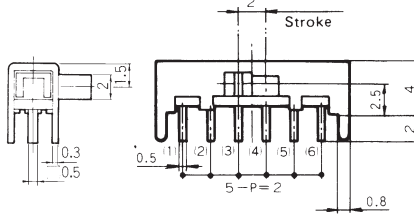

Terminal numbers are not shown on the switch.

Specifications

Rating	Max.	DC30V 0.3A (Resistive load)
	Min.	DC5V 10mA (Resistive load)
Initial contact resistance	20mΩ Max.	
Dielectric strength	AC500V 1 minute	
Insulation resistance	100MΩ Min.	
Electrical life	5,000 cycles	
Operating force	3.92±2.45N	
Switch timing	Non-shorting	

Switching function (Viewed from A)		Circuit diagram	No. of terminals
			6
2-3 5-6	2-1 5-4		

MFS201N-24-Z

Non-shorting

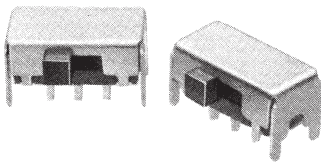

PC Hole Layouts

(Top view)

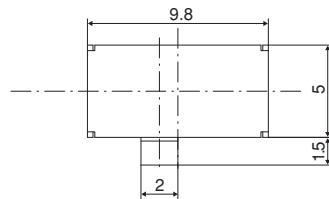
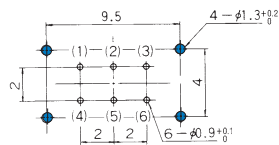

↓ A

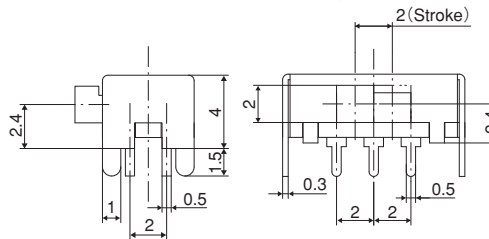

Terminal numbers are not shown on the switch.

Specifications

Rating	Max.	DC30V 0.3A (Resistive load)
	Min.	DC5V 10mA (Resistive load)
Initial contact resistance	20mΩ Max.	
Dielectric strength	AC500V 1 minute	
Insulation resistance	100MΩ Min.	
Electrical life	5,000 cycles	
Operating force	1.96±0.98N	
Switch timing	Non-shorting	

Switching function (Viewed from A)		Circuit diagram	No. of terminals
			6
2-3 5-6	2-1 5-4		

MFS

★MFS201PA-4-Z

※[Note] See below.

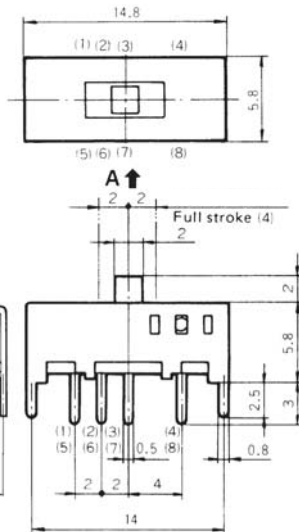
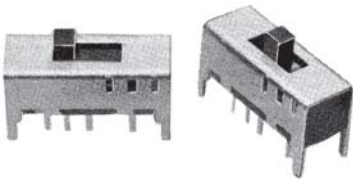

■PC Hole Layouts

(Top view)

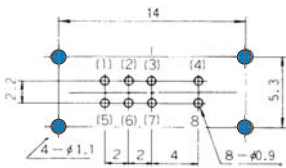

Terminal numbers are not shown on the switch.

■ Specifications

Rating	Max.	DC30V 0.3A (Resistive load)
	Min.	DC5V 10mA (Resistive load)
Initial contact resistance	20mΩ Max.	
Dielectric strength	AC500V 1 minute	
Insulation resistance	100MΩ Min.	
Electrical life	5,000 cycles	
Operating force	$2.45 \pm 0.98\text{N}$ $1.47 \pm 0.98\text{N}$	
Switch timing	Undefined	

Switching function (Viewed from A)			Circuit diagram	No. of terminals
				8
ON	ON	ON		
3-1 7-5	3-2 7-6	3-4 7-8		

: Operating force from the center to the outer side (right or left).
 : Operating force from the outer side (right or left) to the center.

★MFS201PA-5-Z

※[Note] See below.

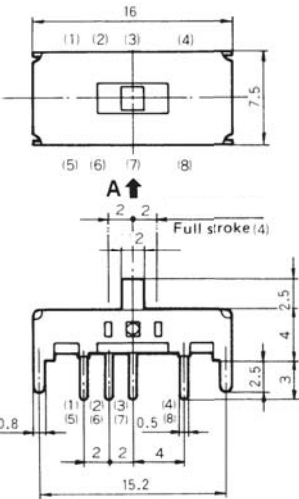
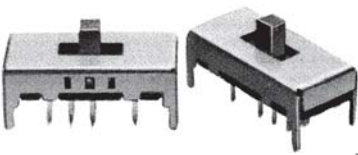

■PC Hole Layouts

(Top view)

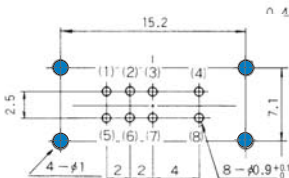

Terminal numbers are not shown on the switch.

■ Specifications

Rating	Max.	DC30V 0.3A (Resistive load)
	Min.	DC5V 10mA (Resistive load)
Initial contact resistance	20mΩ Max.	
Dielectric strength	AC500V 1 minute	
Insulation resistance	100MΩ Min.	
Electrical life	5,000 cycles	
Operating force	$4.41^{+1.67}_{-2.16}\text{N}$	
Switch timing	Undefined	

Switching function (Viewed from A)			Circuit diagram	No. of terminals
				8
ON	ON	ON		
3-1 7-5	3-2 7-6	3-4 7-8		

※ : Please note that MFS201PA-4-Z and MFS201PA-5-Z can be either Shorting or Non-shorting (See page 525).

★ : Made to order products.

MFS

★ **MFS401N-2-Z** Shorting

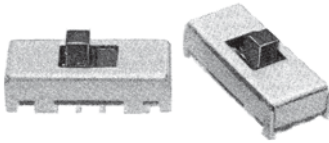

■ **PC Hole Layouts**
(Top view)

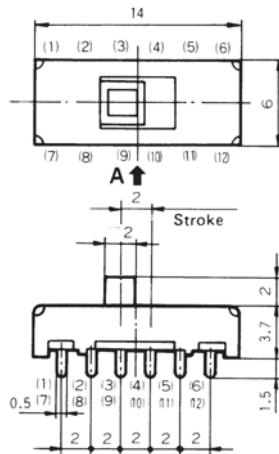
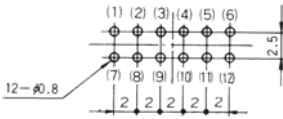

Terminal numbers are not shown on the switch.

■ **Specifications**

Rating	Max.	DC30V 0.3A (Resistive load)
	Min.	DC5V 10mA (Resistive load)
Initial contact resistance	20mΩ Max.	
Dielectric strength	AC500V 1 minute	
Insulation resistance	100MΩ Min.	
Electrical life	5,000 cycles	
Operating force	0.98 N Max. (No detent)	
Switch timing	Shorting	

Switching function (Viewed from A)	Circuit diagram	No. of terminals
ON 2-1 2-3 5-4 5-6 8-7 8-9 11-10 11-12		12

■ **Soldering**

(1) Manual Soldering

Device : Soldering iron

Please refer to “MFS Series Heat-resistant Table” shown below.

(2) Auto Soldering

MFS series are not compatible with auto soldering. Soldering should be done manually.

(3) When soldering two or more terminals to the common land, use solder resist to solder them independently.

■ **Flux Cleaning**

(1) Solvent : Fluorine or Alcohol type.

(2) MSF Series are not process sealed. If the PC board is to be cleaned, clean the soldering surface of substrate with a brush so that the switch is not exposed to the cleaning solution.

■ **Frequency of switch use**

If the switch is not likely to be operated frequently (e.g. two or three operations a year) in the dry circuit area, a sulfide film is likely to be formed on the contacts, resulting in contact failure. If this is the case, gold-plated products are recommended. Please contact your local Nidec Copal Electronics sales representative.

■ **MFS series heat-resistant table**

Resin board	Model	Temperature
Resin board	MFS101D-6-Z	270°C MAX. 3sec MAX.
	MFS101D-9-Z	
	MFS101D-11-Z	
	MFS101D-15-Z	
Phenol board	MFS101D-8-Z	360°C MAX. 3sec MAX.
	MFS201N-19-Z	
	MFS201N-20-Z	
	MFS101D-10-Z	
	MFS101D-14-Z	
	MFS201N-Z	
	MFS201N-4-Z	
	MFS201N-9-Z	
	MFS201N-16-Z	
	MFS201N-21-Z	
	MFS201N-23-Z	
	MFS201N-24-Z	
	MFS201PA-4-Z	
	MFS101EA-Z	
	MFS201PA-5-Z	
	MFS401N-2-Z	

■ **Packaging Specifications**

