

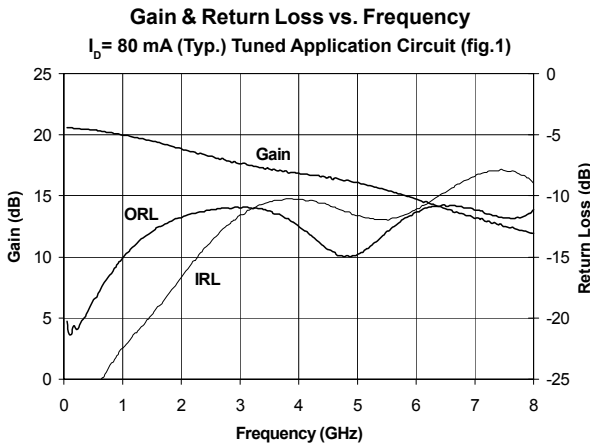

Product Description

The SBW-5089(Z) is a high performance InGaP/GaAs HBT MMIC Amplifier. A Darlington circuit fabricated with InGaP process technology provides broadband RF performance up to 8 GHz and excellent thermal performance. The heterojunction increases breakdown voltage and minimizes leakage current between junctions. Cancellation of emitter junction non-linearities results in high suppression of intermodulation products. Operation requires only a single positive voltage supply, 2 DC-blocking capacitors, a bias resistor and an RF choke.

The matte tin finish on Sirenza's lead-free "Z" package is applied using a post annealing process to mitigate tin whisker formation and is RoHS compliant per EU Directive 2002/95. The package body is manufactured with green molding compounds that contain no antimony trioxide or halogenated fire retardants.



Symbol	Parameter	Units	Frequency	Min.	Typ.	Max.
G	Small Signal Gain (PC board and connector losses de-embedded)	dB	850 MHz 3000 MHz 4200 MHz 6000 MHz	19.3 17.0 17.2 14.5	20.3 18.0 17.2 15.5	21.3 19.0
P_{1dB}	Output Power at 1dB Compression	dBm	850 MHz 1950 MHz	18.4	20.1 19.4	
OIP_3	Output Third Order Intercept Point	dBm	850 MHz 1950 MHz	32.0	35.5 34.0	
P_{out}	Output Power @ -45dBc ACP IS-95 9 Forward Channels	dBm	1950MHz		13.0	
Bandwidth	Determined by Return Loss (>10dB)	MHz			6000	
IRL	Worst case Input Return Loss	dB	DC-6000MHz	7	10	
ORL	Worst case Output Return Loss	dB	DC-6000MHz	8	10	
NF	Noise Figure	dB	1950 MHz		3.9	4.4
V_D	Device Operating Voltage	V		4.5	4.9	5.3
I_b	Device Operating Current	mA		72	80	88
$R_{TH, j-l}$	Thermal Resistance (junction to lead)	$^{\circ}\text{C/W}$			70	
Test Conditions:			$V_s = 8 \text{ V}$ $I_b = 80 \text{ mA Typ.}$	OIP_3 Tone Spacing = 1 MHz		$T_L = 25^{\circ}\text{C}$
			Bias Resistance = 39 Ohms	P_{out} per tone = 0 dBm		$Z_s = Z_L = 50 \text{ Ohms}$

SBW-5089

SBW-5089Z



DC-8 GHz Cascadable InGaP/GaAs HBT MMIC Amplifier

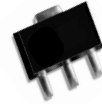

Product Features

- Available in Lead Free, RoHS Compliant green package (Z Suffix)
- 50 Ohm Cascadable Gain Block
- Wideband Flat Gain to 3 GHz: +/-1.4dB
- $P_{1dB} = 13.4 @ 6 \text{ GHz}$
- Input / Output VSWR < 2:3 to 8 GHz
- Patented Thermal Design
- Single Voltage Supply Operation

Applications

- Wideband Instrumentation
- Fiber Optic Driver
- OC-48
- Basestation
- SAT COM

The information provided herein is believed to be reliable at press time. Sirenza Microdevices assumes no responsibility for inaccuracies or omissions. Sirenza Microdevices assumes no responsibility for the use of this information, and all such information shall be entirely at the user's own risk. Prices and specifications are subject to change without notice. No patent rights or licenses to any of the circuits described herein are implied or granted to any third party. Sirenza Microdevices does not authorize or warrant any Sirenza Microdevices product for use in life-support devices and/or systems. Copyright 2005 Sirenza Microdevices, Inc.. All worldwide rights reserved.

Typical RF Performance at Key Operating Frequencies

Symbol	Parameter	Units	Frequency (MHz)					
			500	850	1950	2400	3500	5800
G	Small Signal Gain	dB	20.5	20.3	19.1	18.7	17.3	15.1
OIP ₃	Output Third Order Intercept Point	dBm	36.5	35.5	34.0	33.0	30.5	25.5
P _{1dB}	Output Power at 1dB Compression	dBm	20.2	20.1	19.4	19.4	17.5	13.4
IRL	Input Return Loss	dB	26	26	19	15	12	12.5
ORL	Output Return Loss	dB	19	17.5	12	11	10.5	10.9
S ₁₂	Reverse Isolation	dB	22	23	23	23	23	23
NF	Noise Figure	dB	3.6	3.6	3.9	3.9	4.1	4.3

Test Conditions: V_S = 8 V I_b = 80 mA Typ. Bias Resistance = 39 Ohms
 OIP₃ Tone Spacing = 1 MHz Pout per tone = 0 dBm
 T_{LEAD} = 25°C Z_S = Z_L = 50 Ohms

* 5.8GHz data measured with tuned app circuit in fig. 2.

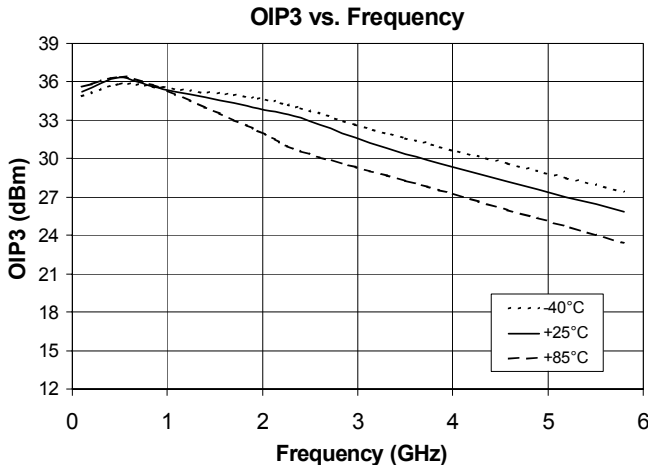
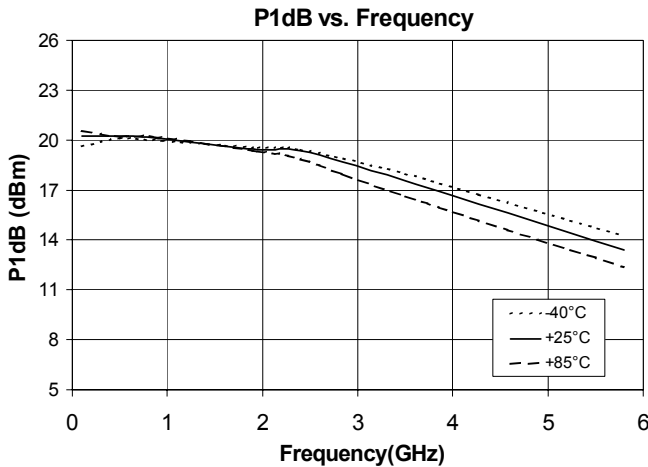

Absolute Maximum Ratings	
Parameter	Absolute Limit
Max. Device Current (I _b)	130 mA
Max. Device Voltage (V _D)	6 V
Max. RF Input Power	+17 dBm
Max. Operating Dissipated Power	0.65 W
Max. Junction Temp. (T _J)	+150°C
Operating Temp. Range (T _L)	-40°C to +85°C
Max. Storage Temp.	+150°C

Operation of this device beyond any one of these limits may cause permanent damage. For reliable continuous operation, the device voltage and current must not exceed the maximum operating values specified in the table on page one.
 Bias conditions should also satisfy the following expression:
 $I_b V_D < (T_J - T_L) / R_{TH} \text{ j-}$

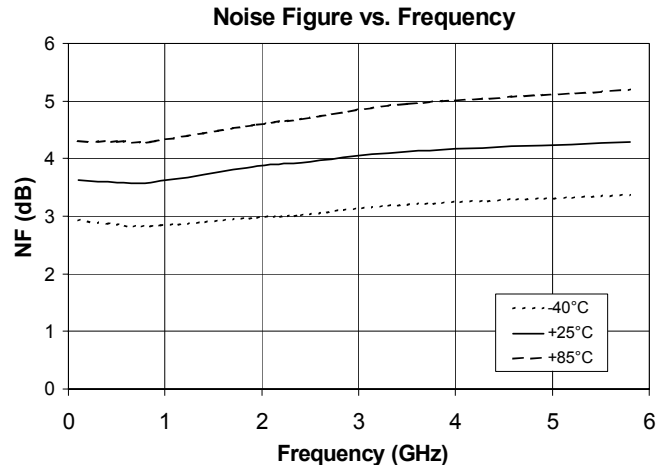

Typical RF Performance Over Lead Temperature In Basic Application Circuit (Fig.2) (Bias: $I_D = 80$ mA Typ.)

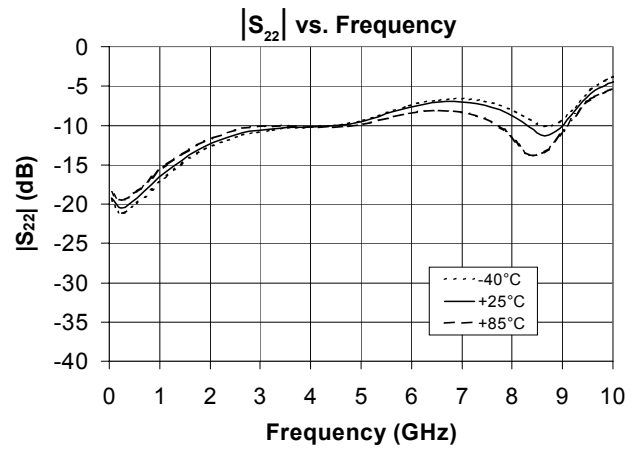
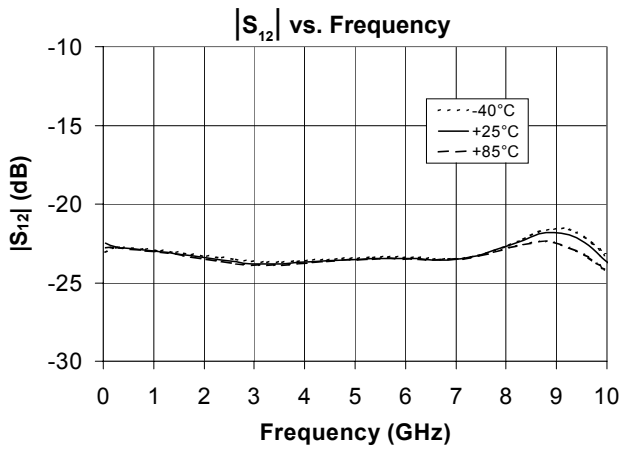
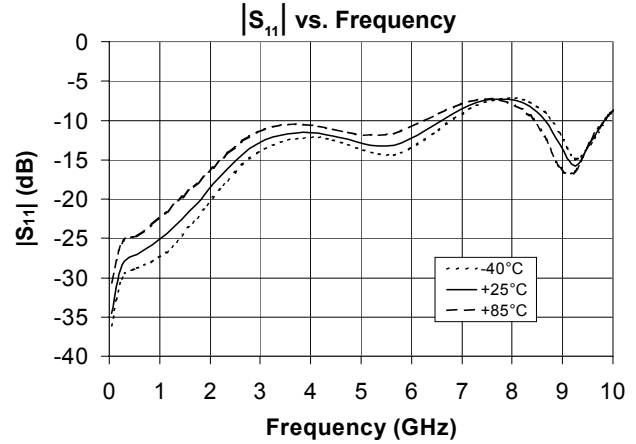
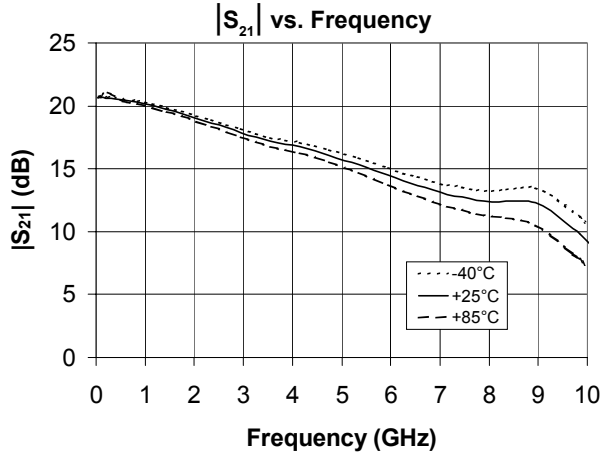

NOTE: Full S-parameter data available at www.sirenza.com

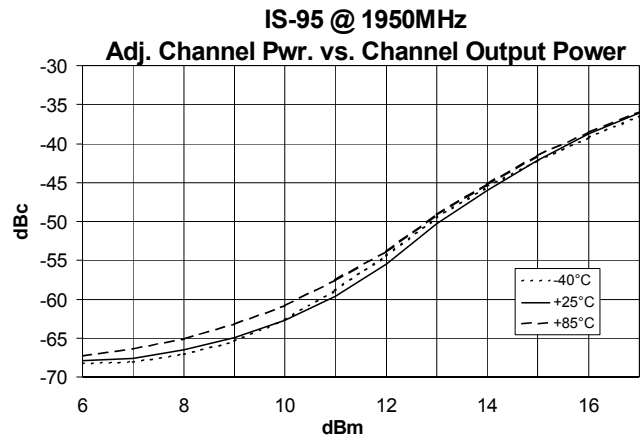
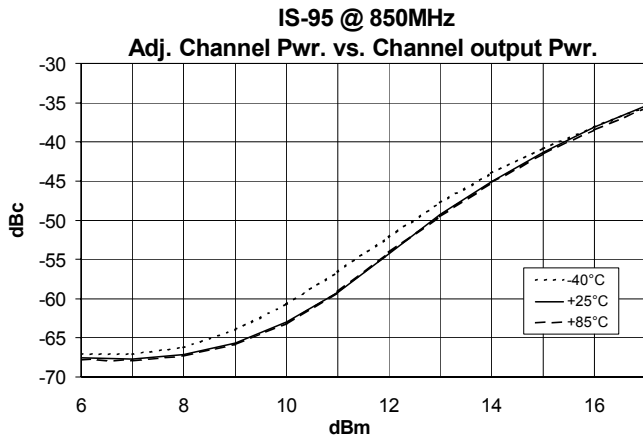

Typical RF Performance Over Lead Temperature In Tuned Application Circuit (Fig.1) (Bias: $I_b = 80$ mA Typ.)

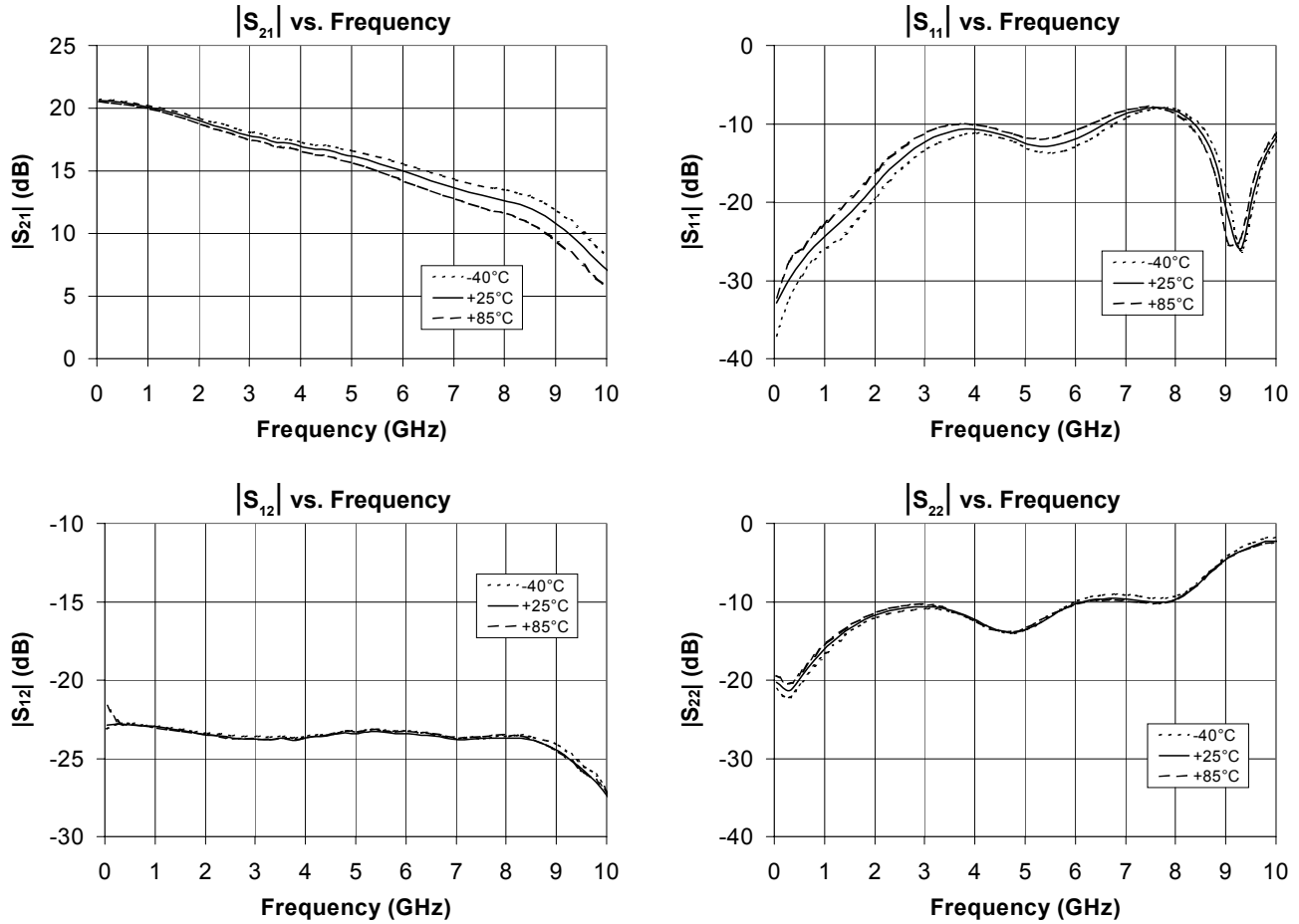

NOTE: Full S-parameter data available at www.sirenza.com

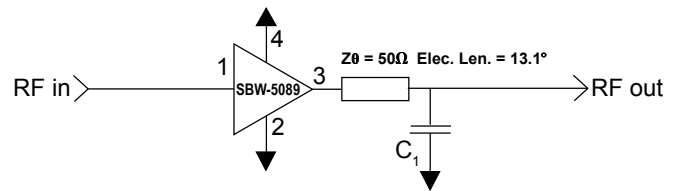
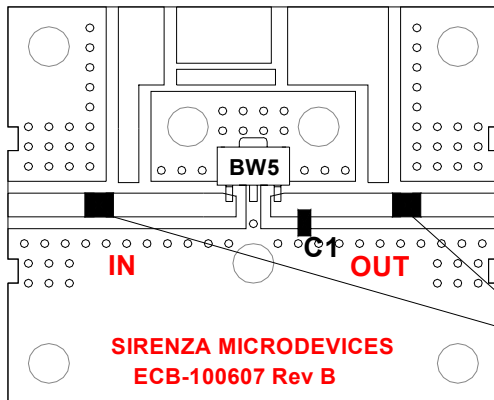

C1 = 0.1pF 0805 AVX

Substrate Material = Getek ML200C, 0.031" thick, Er = 4.2, 1oz. cladding

Copper Shims

Figure 1. Tuned Application Circuit

Fig. 2 Basic Application Circuit

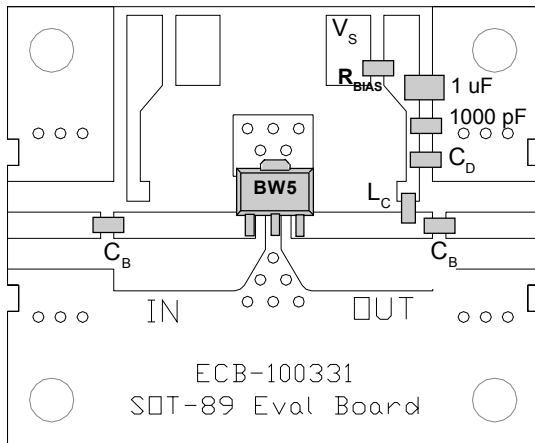
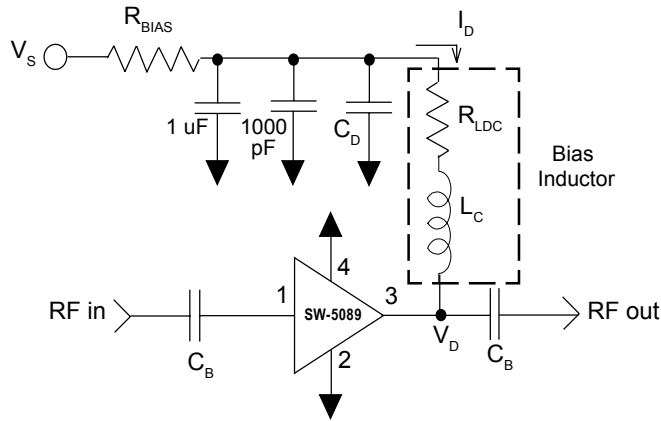

Application Circuit Element Values						
Reference Designator	Frequency (Mhz)					
	100	500	850	1950	2400	3500
C _B	1000 pF	220 pF	100 pF	68 pF	56 pF	39 pF
C _D	100 pF	100 pF	68 pF	22 pF	22 pF	15 pF
L _C	470 nH	68 nH	33 nH	22 nH	18 nH	15 nH

Recommended Bias Resistance for I _D = 80 mA							
Supply Voltage (V _s) (Volts)	< 7	7	7.5	8	9	10	12
Bias Resistance* (Ohms)	N/R	26	33	39	52	64	89

* Bias Resistance = $R_{BIAS} + R_{LDC} = (V_S - V_D) / I_D$
 Select R_{BIAS} so that $R_{BIAS} + R_{LDC} \sim$ the recommended bias resistance. Use 1% or 5% tolerance resistors or parallel combinations to attain the recommended bias resistance +/- 3%. R_{BIAS} provides current stability over temperature.
 * N/R=Not Recommended. Contact Sirenza technical support for guidance when available supply voltage is <7 V.

Device Pin Out Guide		
Pin #	Function	Description
1	RF IN	RF input pin. This pin requires the use of an external DC blocking capacitor chosen for the frequency of operation.
2, 4	GND	Connection to ground. Provide via holes as close to the device ground leads as possible to reduce ground inductance and achieve optimum RF performance.
3	RF OUT / DC BIAS	RF output and bias pin. This pin requires the use of an external DC blocking capacitor chosen for the frequency of operation.

Part Identification Marking

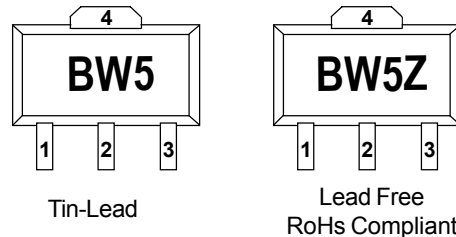

Reliability & Qualification Information	
Parameter	Rating
ESD Rating - Human Body Model (HBM)	Class 1C
Moisture Sensitivity Level	MSL 1

The product qualification report may be downloaded at www.sirenza.com



Caution: ESD sensitive
 Appropriate precautions in handling, packaging and testing devices must be observed.

Part Ordering Information			
Part Number	Package / Lead Composition	Reel Size	Devices / Reel
SBW-5089	Tin-Lead	7"	1000
SBW-5089Z	Lead Free, RoHs Compliant	7"	1000

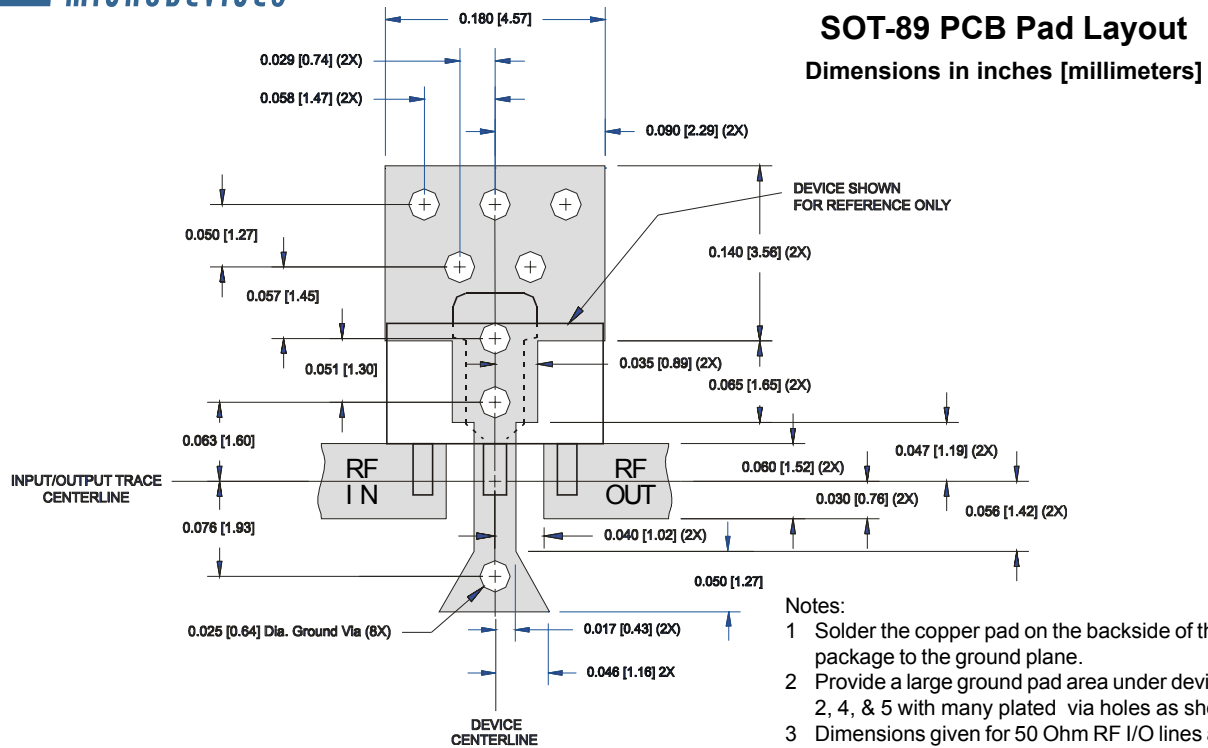

SOT-89 Nominal Package Dimensions

Dimensions in inches [millimeters]

A link to the SOT-89 package outline drawing with full dimensions and tolerances may be found on the product web page at www.sirenza.com.

