

# PRODUCT SPECIFICATION

DATE : 05/02/2011

<b>cosmo</b> ELECTRONICS CORPORATION	SOLID STATE RELAY - MOSFET OUTPUT <b>KAQW210S</b>	NO.62M20004	REV.
		SHEET 1 OF 7	3

## ● OUTSIDE DIMENSION :

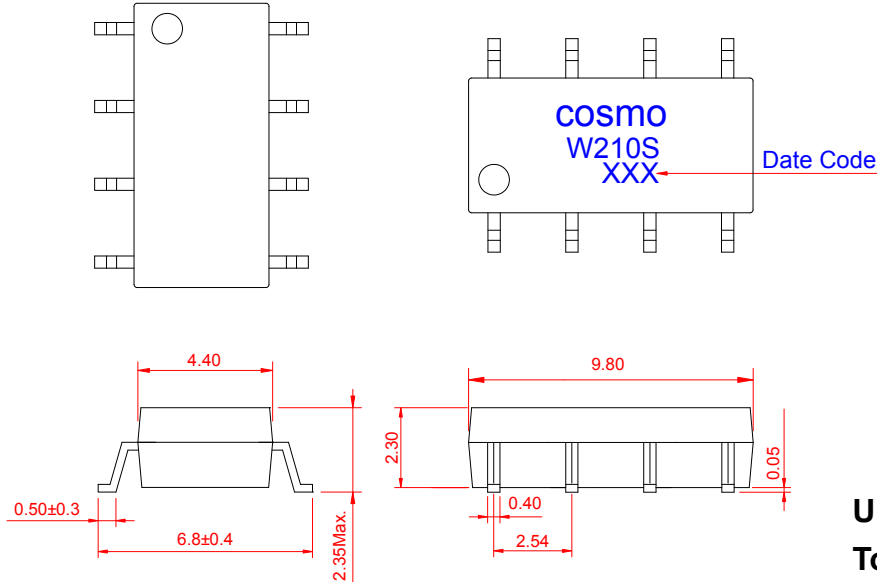

Unit : mm  
Tolerance : ±0.2mm

## ● Turn On / Turn Off time

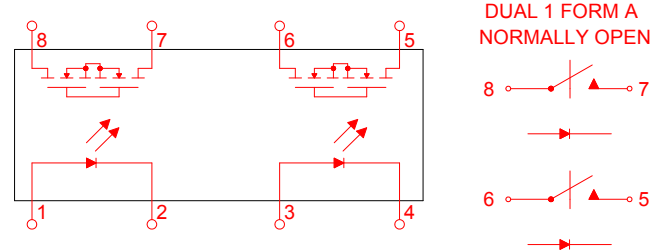
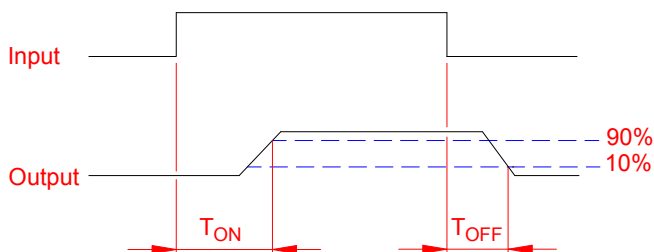

DUAL 1 FORM A  
NORMALLY OPEN

8 — o — | — o — 7  
→

6 — o — | — o — 5  
→

## ● Absolute Maximum Ratings

(Ta=25°C)

Emitter (Input)	Detector (Output)
Reverse Voltage ..... 5.0V	Output Breakdown Voltage ..... ± 350V
Continuous Forward Current ..... 50mA	Continuous Load Current ..... ± 130mA
Peak Forward Current ..... 1A	Power Dissipation ..... 500mW
Power Dissipation ..... 100mW	
Derate Linearly from 25°C ..... 1.3mW/°C	
General Characteristics	
Isolation Test Voltage ..... 1500VACrms	Storage Temperature Range ..... -40°C to +125°C
Isolation Resistance	Operating Temperature Range ... -40°C to +85°C
Vio=500V , Ta=25°C ..... ≥ 10 <sup>10</sup> Ω	Junction Temperature ..... 100°C
Total Power Dissipation ..... 550mW	Soldering Temperature ,
Derate Linearly from 25°C ..... 2.5mW/°C	2mm from case , 10 sec ..... 260°C

# PRODUCT SPECIFICATION

DATE : 05/02/2011

<b>cosmo</b> ELECTRONICS CORPORATION	SOLID STATE RELAY - MOSFET OUTPUT <b>KAQW210S</b>	NO.62M20004	REV.
		SHEET 2 OF 7	3

## ● Electro-optical Characteristics

(Ta=25°C)

Parameter	Symbol	Conditions	Min.	Typ.	Max.	Unit.
Emitter ( Input )						
Forward Voltage	$V_F$	$I_F=10\text{mA}$		1.2	1.5	V
Operation Input Current	$I_{F\text{ON}}$	$V_L=\pm 20\text{V}$ , $I_L=100\text{mA}$ , $t=10\text{ms}$			5.0	mA
Recovery Input Current	$I_{F\text{OFF}}$	$V_L=\pm 20\text{V}$ , $I_L \leq 5\mu\text{A}$	0.2			mA
Detector ( Output )						
Output Breakdown Voltage	$V_B$	$I_B=50\mu\text{A}$	350			V
Output Off-State Leakage	$I_{T\text{OFF}}$	$V_T=350\text{V}$ , $I_F=0\text{mA}$		0.2	1	$\mu\text{A}$
I/O Capacitance	$C_{\text{ISO}}$	$I_F=0$ , $f=1\text{MHz}$		6		pF
ON Resistance	$R_{\text{ON}}$	$I_L=100\text{mA}$ , $I_F=10\text{mA}$		20	30	$\Omega$
Turn-On Time	$T_{\text{ON}}$	$I_F=10\text{mA}$ , $V_L=\pm 20\text{V}$ $t=10\text{ms}$ , $I_L=\pm 100\text{mA}$		0.3	1.0	ms
Turn-Off Time	$T_{\text{OFF}}$			0.1	1.0	ms

## ● Schematic and Wiring Diagrams

Schematic	Output Configuration	Load	Connection	Wiring Diagrams
	2a	AC/DC	-	<p>( 1 ) Two Independent 1 Form A use</p> <p>( 2 ) 2 Form A use</p>

# PRODUCT SPECIFICATION

DATE : 05/02/2011

**cosmo**  
ELECTRONICS CORPORATION

SOLID STATE RELAY - MOSFET OUTPUT  
**KAQW210S**

NO.62M20004  
SHEET 3 OF 7

REV.  
3

## ● Data Curve

Load current vs. ambient temperature  
Allowable ambient Temperature :  
-40°C to +85°C

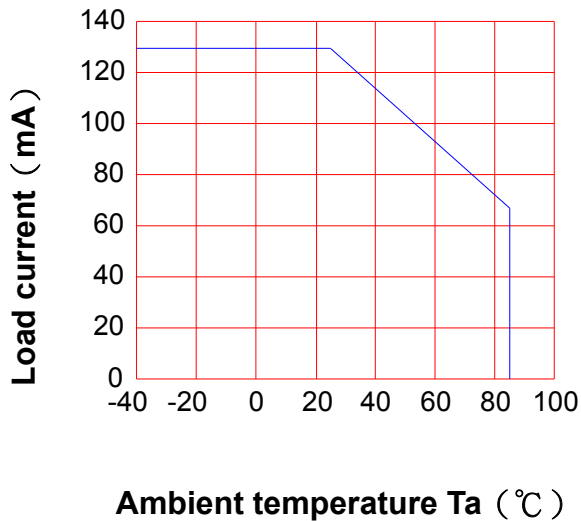

On resistance vs. ambient temperature  
across terminals 5,7 and 6,8 pin  
LED current : 5mA  
Continuous load current : 130mA (DC)

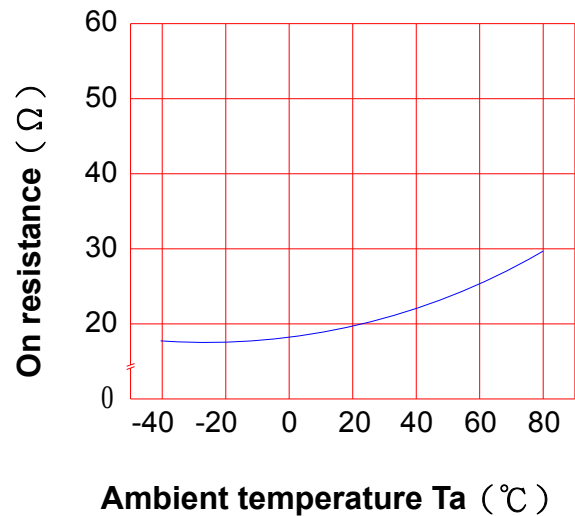

Turn On Time vs. ambient temperature  
Load voltage 350V (DC)  
LED current : 5mA  
Continuous load current : 130mA (DC)

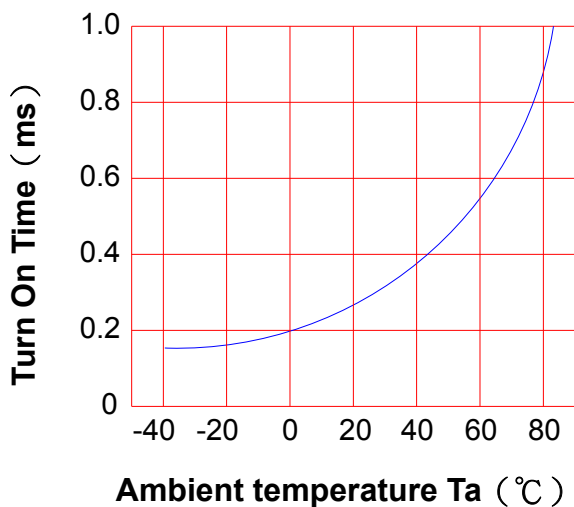

Turn Off Time vs. ambient temperature  
Load voltage 350V (DC)  
LED current : 5mA  
Continuous load current : 130mA (DC)

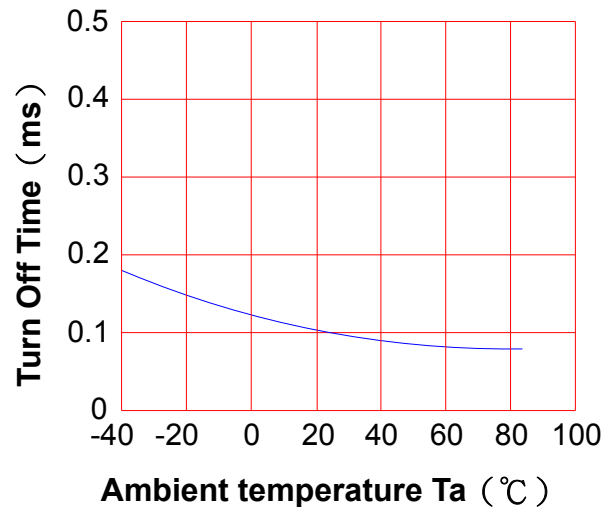

# PRODUCT SPECIFICATION

DATE : 05/02/2011

**cosmo**  
ELECTRONICS CORPORATION

SOLID STATE RELAY - MOSFET OUTPUT  
**KAQW210S**

NO.62M20004  
SHEET 4 OF 7

REV.  
3

LED operate current vs.  
ambient temperature

Load Voltage : 350V (DC)

Continuous load current : 130mA (DC)

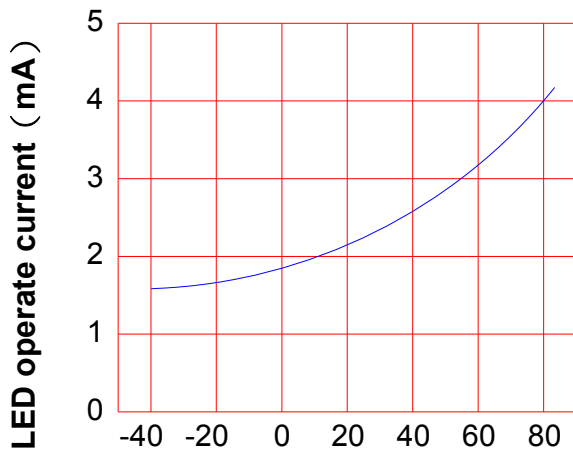

Ambient temperature Ta (°C)

LED Turn Off current vs.  
ambient temperature

Load Voltage : 350V (DC)

Continuous load current : 130mA (DC)

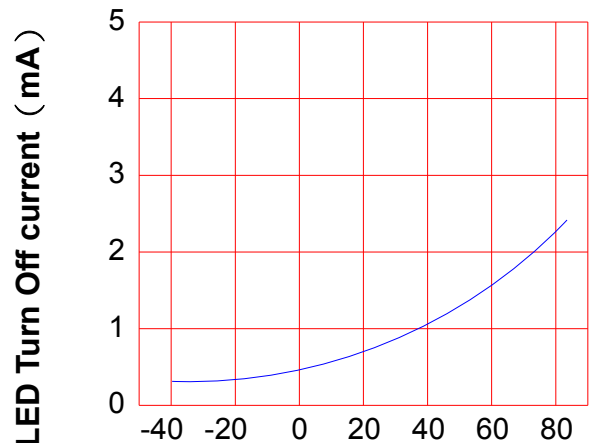

Ambient temperature Ta (°C)

LED dropout voltage vs.  
ambient temperature

LED current : 5 to 50mA

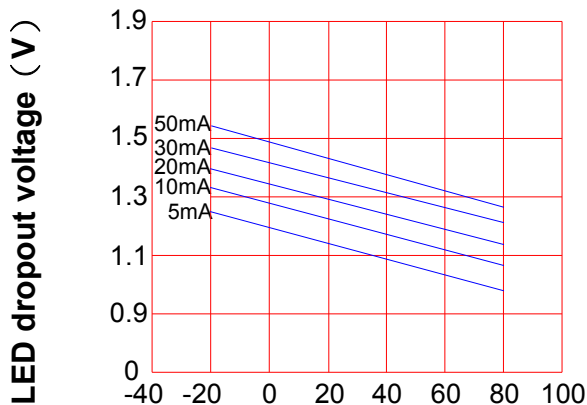

Ambient temperature Ta (°C)

Voltage vs. current characteristics  
of output at MOSFET portion

Measured portion : across terminals  
5,7 and 6,8 pin

Ambient temperature : 25°C

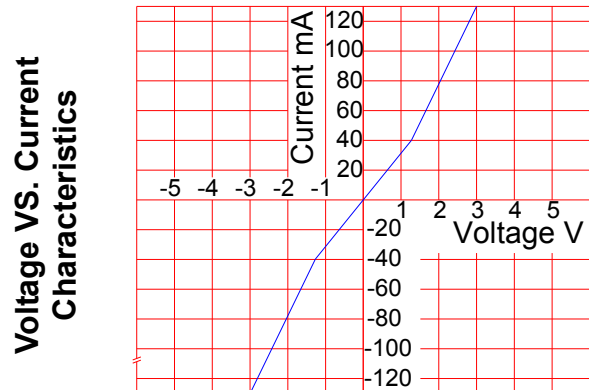

Ambient temperature : 25°C

# PRODUCT SPECIFICATION

DATE : 05/02/2011

**cosmo**  
ELECTRONICS CORPORATION

SOLID STATE RELAY - MOSFET OUTPUT  
**KAQW210S**

NO.62M20004  
SHEET 5 OF 7

REV.  
3

## LED forward current vs. Turn On Time

Across terminals 5,7 and 6,8 pin

Load voltage : 350V (DC)

Continuous load current : 130mA (DC)

Ambient temperature : 25°C

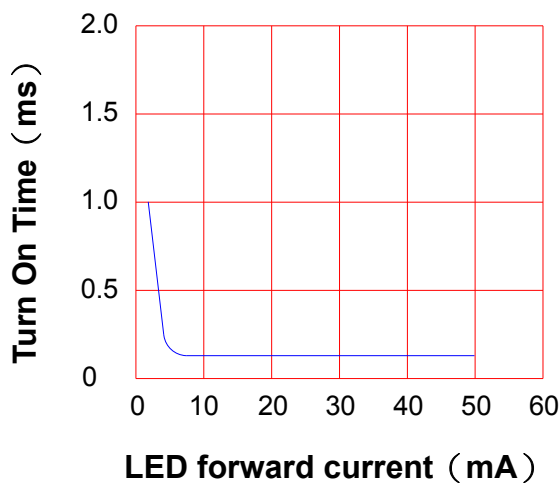

## Off state leakage current

Across terminals 5,7 and 6,8 pin

Ambient temperature : 25°C

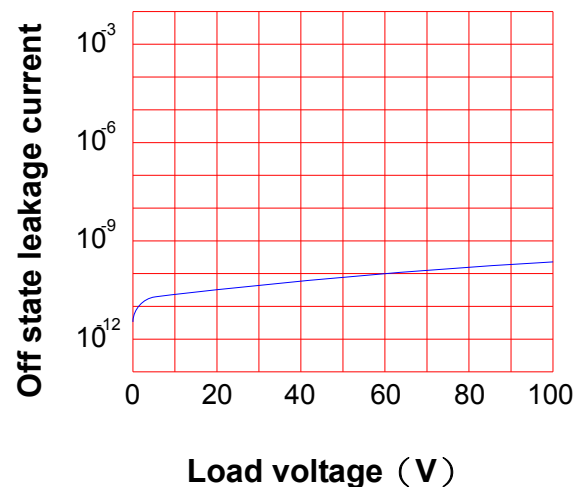

## LED forward current vs. reverse(ON) time

Across terminals 5,7 and 6,8 pin

Load voltage : 350V (DC)

Continuous load current : 130mA (DC)

Ambient temperature : 25°C

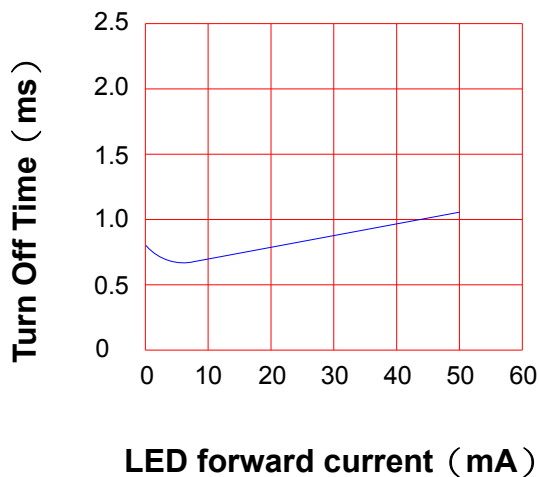

## Applied voltage vs. output capacitance

Across terminals 5,7 and 6,8 pin

Frequency : 1MHz

Ambient temperature : 25°C

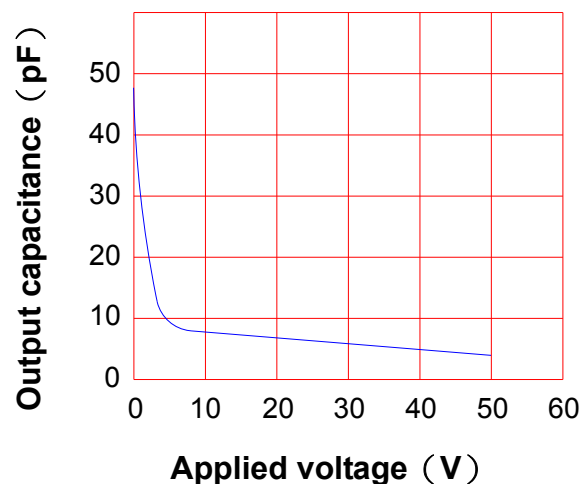

# PRODUCT SPECIFICATION

DATE : 05/02/2011

**cosmo**  
ELECTRONICS CORPORATION

SOLID STATE RELAY - MOSFET OUTPUT  
**KAQW210S**

NO.62M20004  
SHEET 6 OF 7

REV.  
3

## ● USING METHODS

Examples of resistance value to control LED forward current ( $I_F$ )

SSR-MOSFET OUTPUT

( $I_F=5\text{mA}$ )

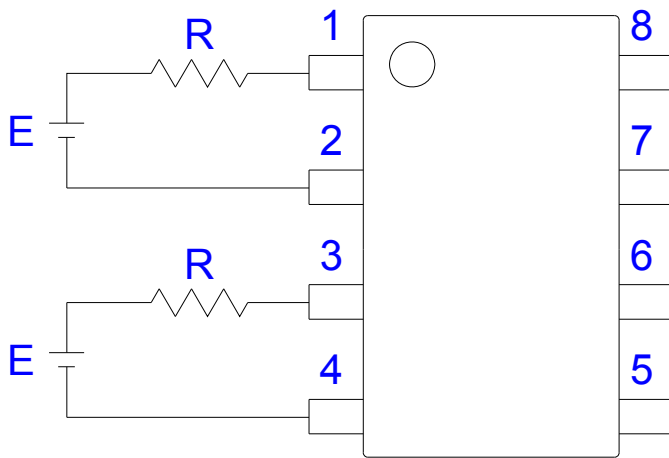

E	R
3.3V	Approx. 330 $\Omega$
5V	Approx. 640 $\Omega$
12V	Approx. 1.9K $\Omega$
15V	Approx. 2.5K $\Omega$
24V	Approx. 4.1K $\Omega$

- (1) LED forward current must be more than 5mA , at E min.
- (2) LED forward current must be less than 50mA , at E max.

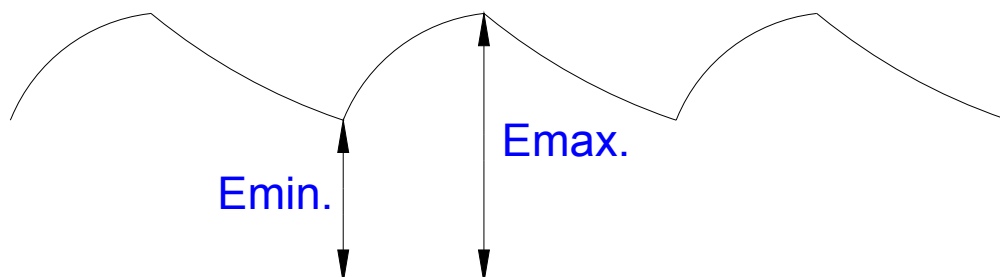

# PRODUCT SPECIFICATION

DATE : 05/02/2011

**cosmo**  
ELECTRONICS CORPORATION

SOLID STATE RELAY - MOSFET OUTPUT  
**KAQW210S**

NO.62M20004  
SHEET 7 OF 7

REV.  
3

## ● USING METHODS

Regulate the spike voltage generated on the inductive load as follows :

