

Data sheet | Item number: 750-493

3-Phase Power Measurement; 480 VAC, 1 A

www.wago.com/750-493

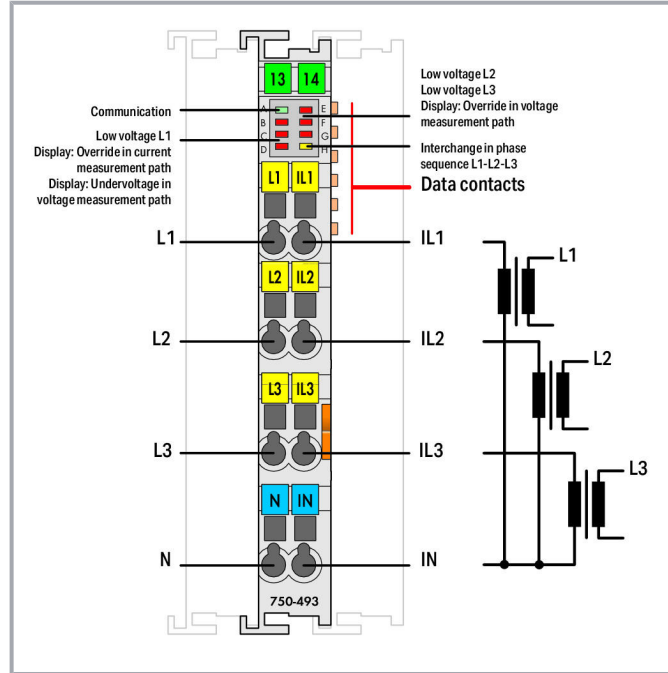
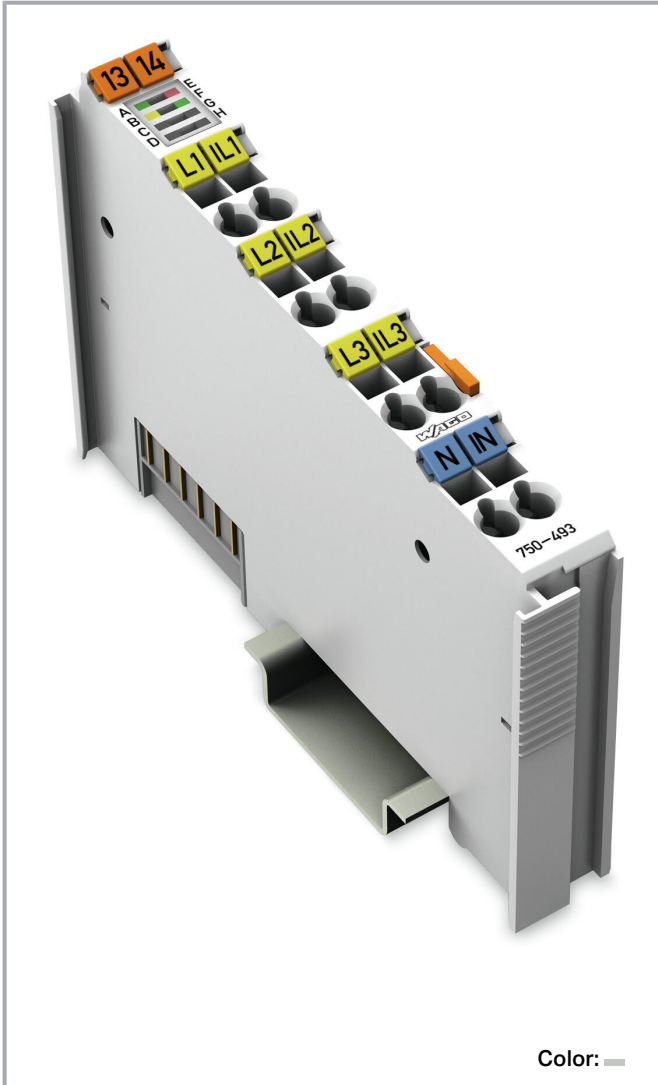

Subject to changes. Please also observe the further product documentation!

WAGO Kontakttechnik GmbH & Co. KG
Hansastr. 27
32423 Minden
Phone: +49571 887-0 | Fax: +49571 887-169
Email: info.de@wago.com | Web: www.wago.com

Do you have any questions about our products?
We are always happy to take your call at +49 (571) 887-44222.

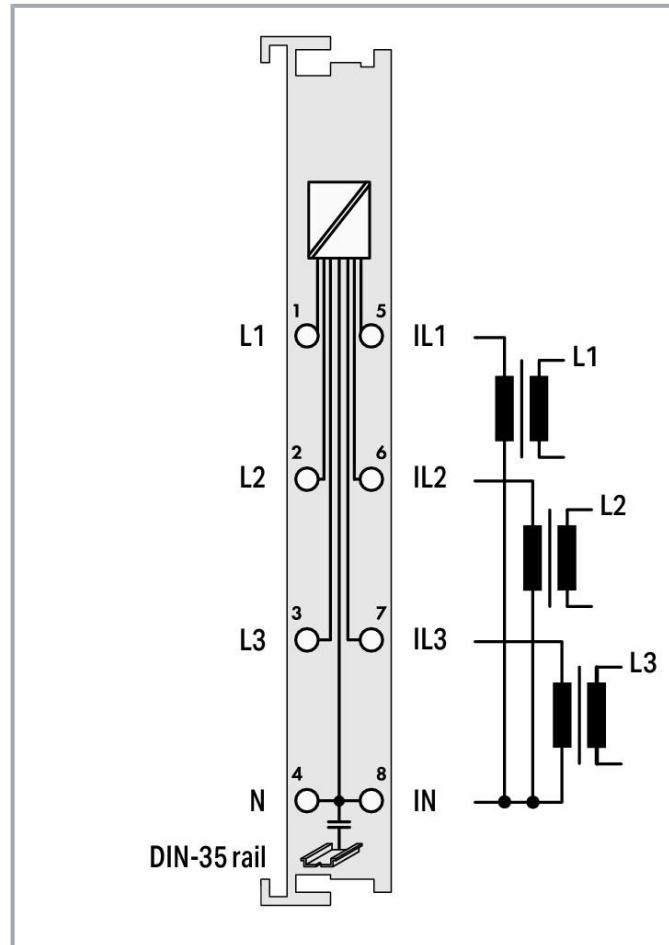
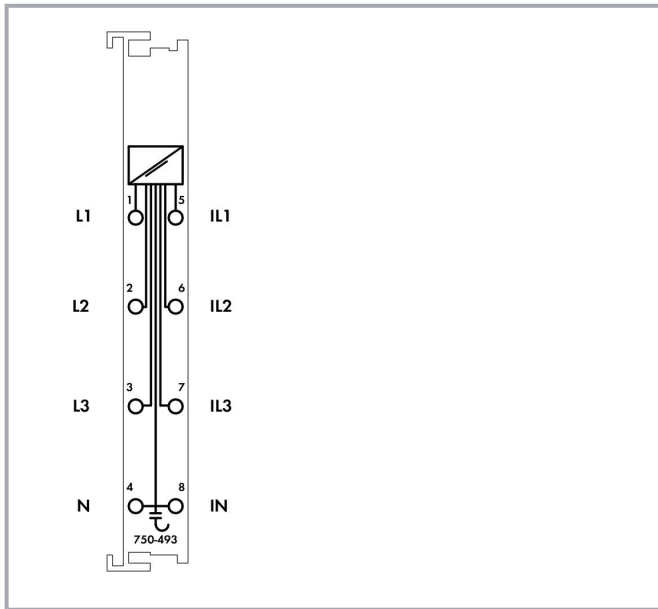

Item description

The 750-493 3-Phase Power Measurement Module measures the electrical data in a three-phase supply network.

The voltage is measured via network connection to L1, L2, L3 and N.

The current of the three phases is fed to IL1, IL2, IL3 and IN via current transformers.

The 750-493 Module transmits the root mean square values into the process image without requiring high computing power from the controller. For each phase, the effective power (P) and the energy consumption (W) are calculated by the module using the root mean square values for all measured voltages (V) and currents (I). For example, both the apparent power (S) and phase shift angle (φ) can be easily derived from these values.

Therefore, the 750-493 Module provides comprehensive network analysis via fieldbus. Metrics, such as effective and apparent power consumption or load condition, enable the operator to optimize supply to a drive or machine. This can protect the installation from damage and failure.

Subject to changes. Please also observe the further product documentation!

Data

Technical data

Number of measurement inputs	6 (3 voltage measurement inputs, 3 current measurement inputs)
Signal type	Power measurement
Signal form	Any periodic signals (considering the threshold frequencies)
Resolution [bit]	16 bits
Data width	2 x 48-bit data; 2 x 24-bit control/status (optional)
Voltage path input resistance (typ.)	1071 k Ω
Current path input resistance (typ.)	22 m Ω
Reference for measurement error	AC current/voltage
Measurement error (reference temperature)	25 °C
Measurement error – deviation (max.) from the upper-range value	0.5 %
Measurement current (max.)	1 A
Measurement voltage (max.)	500 VAC, 3 phases
Measurement cycle time	Adjustable measuring cycle time for Min_Max_Values
Frequency range with activated DC filter	10 ... 2000 Hz
Frequency range with deactivated DC filter	0 ... 2000 Hz
Frequency range (mains frequency)	45 ... 65 Hz
Limit frequency	7.2 kHz
Rated voltage	$U_{LN} = 277$ V AC/DC; $U_{LL} = 480$ VAC
Calculated values	Active power, active energy, grid frequency, $\cos \varphi$
Measurement components	Evaluating
Measurement method	True RMS measurement
Supply voltage (system)	5 VDC; via data contacts
Power consumption (5 V system supply)	100 mA
Isolation	4 kV system/field
Rated surge voltage	4 kV

Connection data

Connection technology: inputs/outputs	8 x CAGE CLAMP [®]
Connection type (1)	Inputs/Outputs
Solid conductor	0.08 ... 2.5 mm ² / 28 ... 14 AWG
Fine-stranded conductor	0.08 ... 2.5 mm ² / 28 ... 14 AWG
Strip length	8 ... 9 mm / 0.31 ... 0.35 inch

Subject to changes. Please also observe the further product documentation!



Physical data

Width	12 mm / 0.472 inch
Height	100 mm / 3.937 inch
Depth	67.8 mm / 2.669 inch
Depth from upper edge of DIN-rail	60.6 mm / 2.386 inch

Mechanical data

Mounting type	DIN-35 rail
---------------	-------------

Material data

Color	light gray
Housing material	Polycarbonate; polyamide 6.6
Fire load	0.88 MJ
Weight	48.5 g
Conformity marking	CE

Environmental requirements

Surrounding air temperature (operation)	0 ... 55 °C
Surrounding air temperature (storage)	-40 ... 85 °C
Protection type	IP20
Pollution degree (5)	2 per IEC 61131-2
Operating altitude	0 ... 2000 m
Mounting position	horizontal (standing/lying); vertical
Relative humidity (without condensation)	95 %
Vibration resistance	per IEC 60068-2-6
Shock resistance	15g per IEC 60068-2-27
EMC immunity to interference	per EN 61000-6-2
EMC emission of interference	per EN 61000-6-3
Exposure to pollutants	Per IEC 60068-2-42 and IEC 60068-2-43
Permissible H ₂ S contaminant concentration at a relative humidity 75 %	10 ppm
Permissible SO ₂ contaminant concentration at a relative humidity 75 %	25 ppm

Commercial data

PU (SPU)	1 Stück
----------	---------

Subject to changes. Please also observe the further product documentation!





WAGO Kontakttechnik GmbH & Co. KG
 Hansastr. 27
 32423 Minden
 Phone: +49571 887-0 | Fax: +49571 887-169
 Email: info.de@wago.com | Web: www.wago.com

Do you have any questions about our products?
 We are always happy to take your call at +49 (571) 887-44222.

Packaging type	box
Country of origin	DE
GTIN	4055143374385
Customs tariff number	85389099990

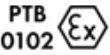
Approvals / Certificates

Ex-Approvals

Logo	Approval	Additional Approval Text	Certificate name
	ATEX TUEV Nord Cert GmbH	EN 60079-0	TÜV 07 ATEX 554086 X en.
 Ex nA IIC T4 Gc	CCCEX CQST/CNEx	CNCA-C23-01	2020312310000215
	EAC Brjansker Zertifizierungsstelle	TP TC 012/2011	EAC RU C-DE.AM02. B.00163/19
	INMETRO TÜV Rheinland do Brasil Ltda.	IEC 60079	BR-Ex_TÜV 12.1297 X
	TUEV Nord TUEV Nord Cert GmbH	IEC 60079-0	IECEX TUN 09.0001 X
	UL Underwriters Laboratories Inc. (HAZARDOUS LOCATIONS)	UL 121201	E198726 Sec.1

Country specific Approvals

Logo	Approval	Additional Approval Text	Certificate name
	KC National Radio Research Agency	Article 58-2, Clause 3	MSIP- REM-W43- AIM750

UL-Approvals

Logo	Approval	Additional Approval Text	Certificate name
------	----------	--------------------------	------------------

Subject to changes. Please also observe the further product documentation!



UL
UL International Netherlands B.V. (ORDINARY
LOCATIONS)

UL 508

E175199
Sec.1

Optional accessories













Marking accessories

✓	Item no.: 2009-145 Mini-WSB Inline; for Smart Printer; 1700 pieces on roll; stretchable 5 - 5.2 mm; plain; snap-on type; white	www.wago.com/2009-145
✓	Item no.: 2009-145/000-002 Mini-WSB Inline; for Smart Printer; 1700 pieces on roll; stretchable 5 - 5.2 mm; plain; snap-on type; yellow	www.wago.com/2009-145/000-002
✓	Item no.: 2009-145/000-005 Mini-WSB Inline; for Smart Printer; 1700 pieces on roll; stretchable 5 - 5.2 mm; plain; snap-on type; red	www.wago.com/2009-145/000-005
✓	Item no.: 2009-145/000-006 Mini-WSB Inline; for Smart Printer; 1700 pieces on roll; stretchable 5 - 5.2 mm; plain; snap-on type; blue	www.wago.com/2009-145/000-006
✓	Item no.: 2009-145/000-007 Mini-WSB Inline; for Smart Printer; 1700 pieces on roll; stretchable 5 - 5.2 mm; plain; snap-on type; gray	www.wago.com/2009-145/000-007
✓	Item no.: 2009-145/000-012 Mini-WSB Inline; for Smart Printer; 1700 pieces on roll; stretchable 5 - 5.2 mm; plain; snap-on type; orange	www.wago.com/2009-145/000-012
✓	Item no.: 2009-145/000-023 Mini-WSB Inline; for Smart Printer; 1700 pieces on roll; stretchable 5 - 5.2 mm; plain; snap-on type; green	www.wago.com/2009-145/000-023
✓	Item no.: 2009-145/000-024 Mini-WSB Inline; for Smart Printer; 1700 pieces on roll; stretchable 5 - 5.2 mm; plain; snap-on type; violet	www.wago.com/2009-145/000-024
✓	Item no.: 248-501 Mini-WSB marking card; as card; not stretchable; plain; snap-on type; white	www.wago.com/248-501
	Item no.: 248-501/000-002 Mini-WSB marking card; as card; not stretchable; plain; snap-on type; yellow	www.wago.com/248-501/000-002
	Item no.: 248-501/000-005 Mini-WSB marking card; as card; not stretchable; plain; snap-on type; red	www.wago.com/248-501/000-005













Subject to changes. Please also observe the further product documentation!

WAGO Kontakttechnik GmbH & Co. KG
Hansastr. 27
32423 Minden
Phone: +49571 887-0 | Fax: +49571 887-169
Email: info.de@wago.com | Web: www.wago.com













Do you have any questions about our products?
We are always happy to take your call at +49 (571) 887-44222.

	Item no.: 248-501/000-006 Mini-WSB marking card; as card; not stretchable; plain; snap-on type; blue	www.wago.com/248-501/000-006
	Item no.: 248-501/000-007 Mini-WSB marking card; as card; not stretchable; plain; snap-on type; gray	www.wago.com/248-501/000-007
	Item no.: 248-501/000-012 Mini-WSB marking card; as card; not stretchable; plain; snap-on type; orange	www.wago.com/248-501/000-012
	Item no.: 248-501/000-017 Mini-WSB marking card; as card; not stretchable; plain; snap-on type; light green	www.wago.com/248-501/000-017
	Item no.: 248-501/000-023 Mini-WSB marking card; as card; not stretchable; plain; snap-on type; green	www.wago.com/248-501/000-023
	Item no.: 248-501/000-024 Mini-WSB marking card; as card; not stretchable; plain; snap-on type; violet	www.wago.com/248-501/000-024
	Item no.: 750-103 Group marker carrier	www.wago.com/750-103
	Item no.: 750-107 Group marker carrier	www.wago.com/750-107
Potential distribution		
	Item no.: 855-951/250-000 Current and voltage tap up to 95 mm ² ; Primary rated current: 250 A; Secondary rated current: 1 A; Rated power: 0.2 VA; Accuracy class: 0.5; fused	www.wago.com/855-951/250-000
Current transformers		
	Item no.: 855-1001/2500-1001 Plug-in current transformer; Primary rated current: 2500 A; Secondary rated current: 1 A; Rated power: 10 VA; Accuracy class: 1	www.wago.com/855-1001/2500-1001
	Item no.: 855-1700/032-000 Plug-in current transformer; Primary rated current 32 A; Secondary rated current 320 mA	www.wago.com/855-1700/032-000
	Item no.: 855-2701/035-001 Plug-in current transformer; Primary rated current: 35 A; Secondary rated current: 1 A; Rated power: 0.2 VA; Accuracy class: 1	www.wago.com/855-2701/035-001
	Item no.: 855-2701/064-001 Plug-in current transformer; Primary rated current: 64 A; Secondary rated current: 1 A; Rated power: 0.2 VA; Accuracy class: 1	www.wago.com/855-2701/064-001

Subject to changes. Please also observe the further product documentation!















	Item no.: 855-3001/060-003 Split-core current transformer; Primary rated current: 60 A; Secondary rated current: 1 A; Rated power: 0.2 VA; Accuracy class: 3; Cable length: 3 m	www.wago.com/855-3001/060-003
	Item no.: 855-3001/100-003 Split-core current transformer; Primary rated current: 100 A; Secondary rated current: 1 A; Rated power: 0.2 VA; Accuracy class: 3; Cable length: 3 m	www.wago.com/855-3001/100-003
	Item no.: 855-3001/200-001 Split-core current transformer; Primary rated current: 200 A; Secondary rated current: 1 A; Rated power: 0.2 VA; Accuracy class: 1; Cable length: 3 m	www.wago.com/855-3001/200-001
	Item no.: 855-3001/250-001 Split-core current transformer; Primary rated current: 250 A; Secondary rated current: 1 A; Rated power: 0.2 VA; Accuracy class: 1; Cable length: 3 m	www.wago.com/855-3001/250-001
	Item no.: 855-301/050-103 Plug-in current transformer; Primary rated current: 50 A; Secondary rated current: 1 A; Rated power: 1.25 VA; Accuracy class: 3	www.wago.com/855-301/050-103
	Item no.: 855-301/060-101 Plug-in current transformer; Primary rated current: 60 A; Secondary rated current: 1 A; Rated power: 1.25 VA; Accuracy class: 1	www.wago.com/855-301/060-101
	Item no.: 855-301/075-201 Plug-in current transformer; Primary rated current: 75 A; Secondary rated current: 1 A; Rated power: 2.5 VA; Accuracy class: 1	www.wago.com/855-301/075-201
	Item no.: 855-301/100-201 Plug-in current transformer; Primary rated current: 100 A; Secondary rated current: 1 A; Rated power: 2.5 VA; Accuracy class: 1	www.wago.com/855-301/100-201
	Item no.: 855-301/150-501 Plug-in current transformer; Primary rated current: 150 A; Secondary rated current: 1 A; Rated power: 5 VA; Accuracy class: 1	www.wago.com/855-301/150-501
	Item no.: 855-301/200-501 Plug-in current transformer; Primary rated current: 200 A; Secondary rated current: 1 A; Rated power: 5 VA; Accuracy class: 1	www.wago.com/855-301/200-501
	Item no.: 855-301/250-501 Plug-in current transformer; Primary rated current: 250 A; Secondary rated current: 1 A; Rated power: 5 VA; Accuracy class: 1	www.wago.com/855-301/250-501
	Item no.: 855-301/400-1001 Plug-in current transformer; Primary rated current: 400 A; Secondary rated current: 1 A; Rated power: 10 VA; Accuracy class: 1	www.wago.com/855-301/400-1001
	Item no.: 855-301/600-1001 Plug-in current transformer; Primary rated current: 600 A; Secondary rated current: 1 A; Rated power: 10 VA; Accuracy class: 1	www.wago.com/855-301/600-1001
	Item no.: 855-4001/100-001	

Subject to changes. Please also observe the further product documentation!

	Split-core current transformer; Primary rated current: 100 A; Secondary rated current: 1 A; Rated power: 0.2 VA; Accuracy class: 1; Cable length: 3 m	www.wago.com/855-4001/100-001
	Item no.: 855-4001/150-001	
	Split-core current transformer; Primary rated current: 150 A; Secondary rated current: 1 A; Rated power: 0.2 VA; Accuracy class: 1; Cable length: 3 m	www.wago.com/855-4001/150-001
	Item no.: 855-4001/200-001	
	Split-core current transformer; Primary rated current: 200 A; Secondary rated current: 1 A; Rated power: 0.2 VA; Accuracy class: 0.5; Cable length: 3 m	www.wago.com/855-4001/200-001
	Item no.: 855-401/250-501	
	Plug-in current transformer; Primary rated current: 250 A; Secondary rated current: 1 A; Rated power: 5 VA; Accuracy class: 1	www.wago.com/855-401/250-501
	Item no.: 855-401/400-501	
	Plug-in current transformer; Primary rated current: 400 A; Secondary rated current: 1 A; Rated power: 5 VA; Accuracy class: 1	www.wago.com/855-401/400-501
	Item no.: 855-401/600-501	
	Plug-in current transformer; Primary rated current: 600 A; Secondary rated current: 1 A; Rated power: 10 VA; Accuracy class: 1	www.wago.com/855-401/600-501
	Item no.: 855-4101/200-001	
	Split-core current transformer; Primary rated current: 200 A; Secondary rated current: 1 A; Rated power: 0.2 VA; Accuracy class: 1; Cable length: 3 m	www.wago.com/855-4101/200-001
	Item no.: 855-4101/250-001	
	Split-core current transformer; Primary rated current: 250 A; Secondary rated current: 1 A; Rated power: 0.2 VA; Accuracy class: 1; Cable length: 3 m	www.wago.com/855-4101/250-001
	Item no.: 855-4101/400-001	
	Split-core current transformer; Primary rated current: 400 A; Secondary rated current: 1 A; Rated power: 0.2 VA; Accuracy class: 1; Cable length: 3 m	www.wago.com/855-4101/400-001
	Item no.: 855-5001/1000-000	
	Split-core current transformer; Primary rated current: 1000 A; Secondary rated current: 1 A; Rated power: 0.5 VA; Accuracy class: 0.5; Cable length: 5 m	www.wago.com/855-5001/1000-000
	Item no.: 855-5001/250-001	
	Split-core current transformer; Primary rated current: 250 A; Secondary rated current: 1 A; Rated power: 0.5 VA; Accuracy class: 1; Cable length: 5 m	www.wago.com/855-5001/250-001
	Item no.: 855-5001/400-000	
	Split-core current transformer; Primary rated current: 400 A; Secondary rated current: 1 A; Rated power: 0.5 VA; Accuracy class: 0.5; Cable length: 5 m	www.wago.com/855-5001/400-000
	Item no.: 855-5001/600-000	
	Split-core current transformer; Primary rated current: 600 A; Secondary rated current: 1 A; Rated power: 0.5 VA; Accuracy class: 0.5; Cable length: 5 m	www.wago.com/855-5001/600-000

Item no.: 855-501/1000-1001

Subject to changes. Please also observe the further product documentation!





	Plug-in current transformer; Primary rated current: 1000 A; Secondary rated current: 1 A; Rated power: 10 VA; Accuracy class: 1	www.wago.com/855-501/1000-1001
	Item no.: 855-501/400-1001 Plug-in current transformer; Primary rated current: 400 A; Secondary rated current: 1 A; Rated power: 10 VA; Accuracy class: 1	www.wago.com/855-501/400-1001
	Item no.: 855-501/600-1001 Plug-in current transformer; Primary rated current: 600 A; Secondary rated current: 1 A; Rated power: 10 VA; Accuracy class: 1	www.wago.com/855-501/600-1001
	Item no.: 855-501/800-1001 Plug-in current transformer; Primary rated current: 800 A; Secondary rated current: 1 A; Rated power: 10 VA; Accuracy class: 1	www.wago.com/855-501/800-1001
	Item no.: 855-5101/1000-000 Split-core current transformer; Primary rated current: 1000 A; Secondary rated current: 1 A; Rated power: 0.5 VA; Accuracy class: 0.5; Cable length: 5 m	www.wago.com/855-5101/1000-000
	Item no.: 855-601/1500-501 Plug-in current transformer; Primary rated current: 1500 A; Secondary rated current: 1 A; Rated power: 5 VA; Accuracy class: 1	www.wago.com/855-601/1500-501
	Item no.: 855-801/1000-1001 Plug-in current transformer; Primary rated current: 1000 A; Secondary rated current: 1 A; Rated power: 10 VA; Accuracy class: 1	www.wago.com/855-801/1000-1001
	Item no.: 855-801/2000-1001 Plug-in current transformer; Primary rated current: 2000 A; Secondary rated current: 1 A; Rated power: 10 VA; Accuracy class: 1	www.wago.com/855-801/2000-1001
Shield termination		
	Item no.: 790-108 Shield clamping saddle; 11 mm wide; diameter of compatible conductor; 3 ... 8 mm	www.wago.com/790-108
	Item no.: 790-116 Shield clamping saddle; 19 mm wide; diameter of compatible conductor; 7 ... 16 mm	www.wago.com/790-116
	Item no.: 790-124 Shield clamping saddle; 27 mm wide; diameter of compatible conductor; 6 ... 24 mm	www.wago.com/790-124
	Item no.: 790-140 Shield clamping saddle; diameter of compatible conductor	www.wago.com/790-140
	Item no.: 790-208 Shield clamping saddle; 12.4 mm wide; 3 ... 8 mm	www.wago.com/790-208
	Item no.: 790-216 Shield clamping saddle; 21.8 mm wide; 6 ... 16 mm	www.wago.com/790-216
	Item no.: 790-220 Shield clamping saddle; 30 mm wide; 6 ... 20 mm	www.wago.com/790-220

Subject to changes. Please also observe the further product documentation!

Carrier rail

	Item no.: 210-112 Steel carrier rail; 35 x 7.5 mm; 1 mm thick; 2 m long; slotted; according to EN 60715; "Hole width 25 mm; silver-colored	www.wago.com/210-112
	Item no.: 210-113 Steel carrier rail; 35 x 7.5 mm; 1 mm thick; 2 m long; unslotted; according to EN 60715; silver-colored	www.wago.com/210-113
	Item no.: 210-114 Steel carrier rail; 35 x 15 mm; 1.5 mm thick; 2 m long; unslotted; similar to EN 60715; silver-colored	www.wago.com/210-114
	Item no.: 210-115 Steel carrier rail; 35 x 7.5 mm; 1 mm thick; 2 m long; slotted; according to EN 60715; "Hole width 18 mm; silver-colored	www.wago.com/210-115
	Item no.: 210-118 Steel carrier rail; 35 x 15 mm; 2.3 mm thick; 2 m long; unslotted; according to EN 60715; silver-colored	www.wago.com/210-118
	Item no.: 210-196 Aluminum carrier rail; 35 x 8.2 mm; 1.6 mm thick; 2 m long; unslotted; similar to EN 60715; silver-colored	www.wago.com/210-196
	Item no.: 210-197 Steel carrier rail; 35 x 15 mm; 1.5 mm thick; 2 m long; slotted; similar to EN 60715; silver-colored	www.wago.com/210-197
	Item no.: 210-198 Copper carrier rail; 35 x 15 mm; 2.3 mm thick; 2 m long; unslotted; according to EN 60715; copper-colored	www.wago.com/210-198
	Item no.: 210-504 Steel carrier rail; 35 x 7.5 mm; 1 mm thick; 2 m long; slotted; galvanized; according to EN 60715; silver-colored	www.wago.com/210-504
	Item no.: 210-505 Steel carrier rail; 35 x 7.5 mm; 1 mm thick; 2 m long; unslotted; galvanized; according to EN 60715; silver-colored	www.wago.com/210-505
	Item no.: 210-506 Steel carrier rail; 35 x 15 mm; 1.5 mm thick; 2 m long; unslotted; galvanized; similar to EN 60715; silver-colored	www.wago.com/210-506
	Item no.: 210-508 Steel carrier rail; 35 x 15 mm; 1.5 mm thick; 2 m long; slotted; galvanized; similar to EN 60715; silver-colored	www.wago.com/210-508





System housing

	Item no.: 850-804 IP65 enclosure; Stainless steel; WxHxD (400x123x200 mm); 4 x M20, 16 x M16, 28 x M12 cable grip	www.wago.com/850-804
	Item no.: 850-804/000-001 IP65 enclosure; Stainless steel; WxHxD (400x123x200 mm); 2 x M20, 13 x M16, 32 x M12 cable grip	www.wago.com/850-804/000-001
	Item no.: 850-805 IP65 enclosure; Stainless steel; WxHxD (600x123x200 mm); 4 x M20, 19 x M16, 67 x M12 cable grip	www.wago.com/850-805
	Item no.: 850-814/002-000 IP65 enclosure; Sheet steel (RAL 7035); WxHxD (200x120x200 mm); without flange plate	www.wago.com/850-814/002-000

Subject to changes. Please also observe the further product documentation!

	Item no.: 850-815/002-000 IP65 enclosure; Sheet steel (RAL 7035); WxHxD (300x120x200 mm); without flange plate	www.wago.com/850-815/002-000
	Item no.: 850-816/002-000 IP65 enclosure; Sheet steel (RAL 7035); WxHxD (400x120x200 mm); without flange plate	www.wago.com/850-816/002-000
	Item no.: 850-817/002-000 IP65 enclosure; Sheet steel (RAL 7035); WxHxD (600x120x200 mm); without flange plate	www.wago.com/850-817/002-000
	Item no.: 850-825 IP65 enclosure; Aluminium (RAL 7032); WxHxD (160x100x160 mm); 9 x M12, 4 x M20	www.wago.com/850-825
	Item no.: 850-826 IP65 enclosure; Aluminium (RAL 7032); WxHxD (240x100x160 mm); 4 x M20, 4 x M16, 14 x M12 cable grip	www.wago.com/850-826
	Item no.: 850-826/002-000 IP65 enclosure; Aluminium (RAL 7035); WxHxD (240x100x160 mm); 4 x M20, 4 x M16, 14 x M12 cable grip	www.wago.com/850-826/002-000
	Item no.: 850-827 IP65 enclosure; Aluminium (RAL 7032); WxHxD (320x100x160 mm); 4 x M20, 8 x M16, 17 x M12 cable grip	www.wago.com/850-827
	Item no.: 850-827/002-000 IP65 enclosure; Aluminium (RAL 7035); WxHxD (320x100x160 mm); 4 x M20, 8 x M16, 17 x M12 cable grip	www.wago.com/850-827/002-000
	Item no.: 850-828 IP65 enclosure; Aluminium (RAL 7032); WxHxD (480x100x160 mm); 4 x M20, 10 x M16, 35 x M12 cable grip	www.wago.com/850-828
	Item no.: 850-828/002-000 IP65 enclosure; Aluminium (RAL 7035); WxHxD (480x100x160 mm); 4 x M20, 10 x M16, 35 x M12 cable grip	www.wago.com/850-828/002-000
	Item no.: 850-834 IP65 enclosure; Polyester (RAL 7032); WxHxD (164x100x164 mm); 9 x M12, 4 x M20	www.wago.com/850-834
	Item no.: 850-835 IP65 enclosure; Polyester (RAL 7032); WxHxD (244x100x164 mm); 4 x M20, 4 x M16, 14 x M12 cable grip	www.wago.com/850-835
	Item no.: 850-836 IP65 enclosure; Polyester (RAL 7032); WxHxD (324x100x164 mm); 4 x M20, 8 x M16, 17 x M12 cable grip	www.wago.com/850-836
General accessories		
	Item no.: 2007-8873 Compact terminal block; for current and voltage transformers; 6,00 mm ² ; multicoloured	www.wago.com/2007-8873
	Item no.: 2007-8875	

Subject to changes. Please also observe the further product documentation!

	Compact terminal block; for current transformer circuit; 6,00 mm ² ; multicoloured	www.wago.com/2007-8875
	Item no.: 855-8001 Power tap; with fuse; 2,5 mm ² (12 AWG) - 6 mm ² (10 AWG); Phase	www.wago.com/855-8001
	Item no.: 855-8002 Power tap; without fuse; 2,5 mm ² (12 AWG) - 6 mm ² (10 AWG); N-conductor	www.wago.com/855-8002
	Item no.: 855-8003 Power tap; with fuse; 10 mm ² (8 AWG) - 16 mm ² (6 AWG); Phase	www.wago.com/855-8003
	Item no.: 855-8004 Power tap; without fuse; 10 mm ² (8 AWG) - 16 mm ² (6 AWG); N-conductor	www.wago.com/855-8004

Downloads

Documentation

Manual

3-Phase Power Measurement Module	V 1.2.0	pdf 3.4 MB	Download
System Manual WAGO I/O System 750 / 753 Decentralized Automation Technology	V 3.0.2 2021. 4. 27.	pdf 6.6 MB	Download
System Manual Series 750/753 Online HTML		URL	Download

Bid Text

750-493 docx - Datei	2019. 6. 26.	docx 18.4 kB	Download
750-493 X81 - Datei	2019. 2. 19.	xml 6.0 kB	Download

System Description

Use in Hazardous Environments Term definition, marking and installation regulations	V 1.0.0	pdf 1.0 MB	Download
750/753 Series I/O-System – General Product Information		pdf 1.7 MB	Download
Overview on WAGO-I/O-SYSTEM 750 approvals		pdf 780.2 kB	Download

Subject to changes. Please also observe the further product documentation!



Additional Information

Disposal; Electrical and electronic equipment, Packaging	V 1.0.0	pdf 265.8 kB	Download
--	---------	-----------------	----------

Application Notes

Application Note CoDeSys 2.3

Application Note PowerMeasurement_03 Library	19.01.2011	zip	Download
This application note describes how current, voltage, effective power, power factor and energy consumption can be measured using 3-phase power measurement modules (750-493).	2012. 3. 19.	954.5 kB	

Libraries

Library

Libraries for Building Automation CODESYS 2.3	2021-08-13	zip	Download
This zip file contains WAGO I / O PRO libraries for building automation. Blocks are available for the following applications: - DALI - DALI sensors - DALI Color Control - DALI Emergency Lighting - Enocean - SMI - HVAC / HVAC functions - General building functions such as blinds, dimmers, impulse switches - Scheduler - KNX function blocks - BACnet - WINSTA blind box - DMX - Elsner weather station - M-Bus, MBus - MP-Bus, MPBus - Romutec handset - Thermokon Thanos room thermostat - Thermokon WRF04 room thermostat - Thermokon WRF06 room thermostat - Thermokon WRF07 room thermostat - Thermokon WRF08 room thermostat - 3-phase Power measuring module 750-493 - LON - Grundfos pumps with GENibus interface - EAP Modbus® room control units - Conversion of color formats - "robutecheasy" modules - Schüco TipTronic group control units - Weather station Thies	2021. 8. 13.	76.0 MB	

CAD/CAE-Data

CAD data

2D/3D Models 750-493	URL	Download
----------------------	-----	----------

CAE data

EPLAN Data Portal 750-493	URL	Download
---------------------------	-----	----------

WSCAD Universe 750-493	URL	Download
------------------------	-----	----------

Subject to changes. Please also observe the further product documentation!

WAGO Kontakttechnik GmbH & Co. KG
 Hansastr. 27
 32423 Minden
 Phone: +49571 887-0 | Fax: +49571 887-169
 Email: info.de@wago.com | Web: www.wago.com

Do you have any questions about our products?
 We are always happy to take your call at +49 (571) 887-44222.



ZUKEN Portal 750-493

[URL](#)

[Download](#)

Device Files

Device Driver

WAGO USB Service Kabel Treiber / Serie 750 und 857	6.5.3.0 2014. 9. 10.	zip 4.8 MB	Download
--	-------------------------	---------------	--------------------------

Environmental Product Compliance

Compliance Search

Environmental Product Compliance 750-493 3-Phase Power Measurement; 480 VAC, 1 A	URL	Download
---	---------------------	--------------------------

Installation Notes

Product family

750/753 Series I/O System
[Show all products from the family](#)

Subject to changes. Please also observe the further product documentation!