

## PS2625, PS2626, PS2625L, PS2626L

HIGH ISOLATION VOLTAGE AC INPUT  
LARGE FORWARD AC INPUT TYPE  
6 PIN PHOTOCOUPLER

— NEPOC Series —

**DESCRIPTION**

PS2625, PS2626 and PS2625L, PS2626L are optically coupled isolators containing a GaAs light emitting diode and an NPN silicon phototransistor.

PS2625, PS2626 are in a plastic DIP (Dual In-line Package).

PS2625L, PS2626L are lead bending type (Gull-wing) for surface mount.

PS2625, PS2625L have base pin and PS2622, PS2622L have no base pin.

**FEATURES**

- High isolation voltage (BV: 5 kV<sub>r.m.s.</sub> MIN.)
- AC input response
- Large forward input (current) (I<sub>F</sub>: ±150 mA MAX.)
- High collector to emitter voltage (V<sub>CEO</sub>: 80 V MIN.)
- High speed switching (t<sub>r</sub> = 3 μs, t<sub>f</sub> = 5 μs TYP.)
- UL recognized [File No. E72422(S)]
- Taping product name (PS2625L-E3, E4, PS2626L-E3, E4)

**APPLICATIONS**

Interface circuit for various instrumentations, control equipments.

- AC Line/Digital Logic ..... Isolate high voltage transient
- Digital Logic/Digital Logic ..... Eliminate spurious ground loops
- Twisted pair line receiver ..... Eliminate ground loop pick-up
- Telephone/Telegraph line receiver ..... Isolate high voltage transient
- High Frequency Power Supply Feedback Control ..... Maintain floating ground

**PACKAGE DIMENSIONS (Unit: mm)**

**DIP (Dual In-line Package)**

**Lead Bending type (Gull-wing)**

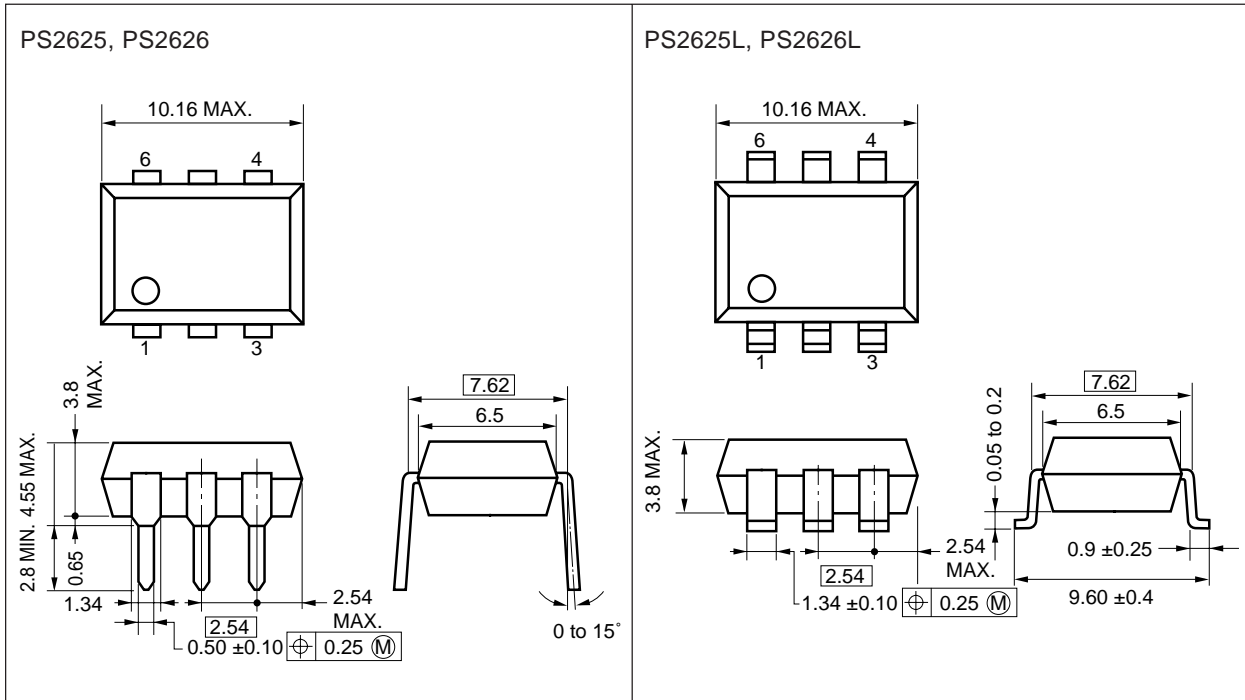

**PIN CONNECTION (Top View)**

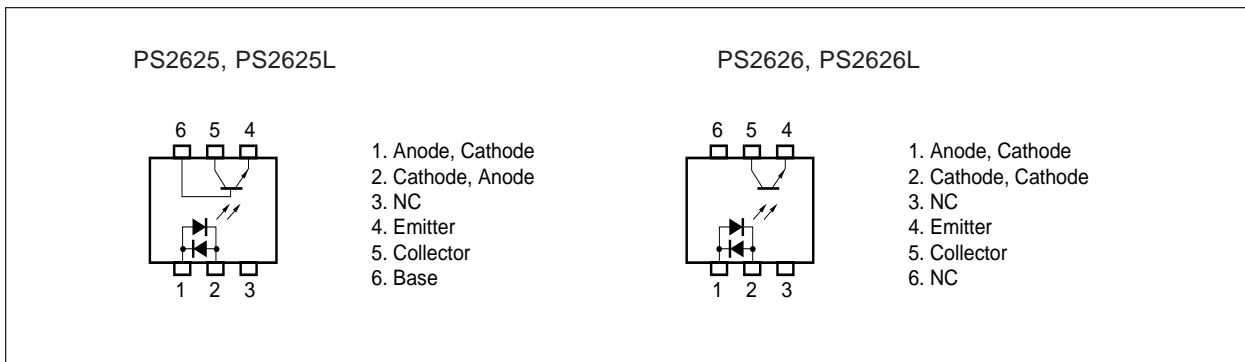

**ABSOLUTE MAXIMUM RATINGS (T<sub>A</sub> = 25 °C)**

Diode

Forward Current (DC)	I <sub>F</sub>	±150	mA
Power Dissipation Derating	ΔP <sub>D</sub> /°C	2.0	mW/°C
Power Dissipation	P <sub>D</sub>	200	mW
Peak Forward Current (PW = 100 μs, Duty Cycle 1 %)	I <sub>F(Peak)</sub>	±1	A

Transistor

Collector to Emitter Voltage	V <sub>CEO</sub>	80	V
Emitter to Collector Voltage	V <sub>ECO</sub>	7	V
Collector Current	I <sub>c</sub>	50	mA
Power Dissipation Derating	ΔP <sub>c</sub> /°C	1.5	mW/°C
Power Dissipation	P <sub>c</sub>	150	mW

Coupled

Isolation Voltage *1)	BV	5 000	V <sub>r.m.s.</sub>
Storage Temperature	T <sub>stg</sub>	-55 to +150	°C
Operating Temperature	T <sub>opt</sub>	-55 to +100	°C

\*1) AC voltage for 1 minute at T<sub>A</sub> = 25 °C, RH = 60 % between input (Pin No. 1, 2, 3, Common) and output (Pin No. 4, 5, 6 Common).

**ELECTRICAL CHARACTERISTICS (T<sub>A</sub> = 25 °C)**

CHARACTERISTIC		SYMBOL	MIN.	TYP.	MAX.	UNIT	TEST CONDITIONS
Diode	Forward Voltage	V <sub>F</sub>		1.3	1.7	V	I <sub>F</sub> = ±100 mA
	Junction Capacitance	C		140		pF	V = 0, f = 1.0 MHz
Transistor	Collector to Emitter Dark Current	I <sub>CEO</sub>			100	nA	V <sub>CE</sub> = 80 V, I <sub>F</sub> = 0
	DC Current Gain*2)	h <sub>FE</sub>		700			I <sub>c</sub> = 2 mA, V <sub>CE</sub> = 5 V
Coupled	Current Transfer Ratio	CTR	20		50	%	I <sub>F</sub> = ±100 mA, V <sub>CE</sub> = 3 V
	CTR Ratio*3)	CTR1/CTR2	0.3	1.0	3.0		I <sub>F</sub> = ±100 mA, V <sub>CE</sub> = 3 V
	Collector Saturation Voltage	V <sub>CE(sat)</sub>			0.3	V	I <sub>F</sub> = ±100 mA, I <sub>c</sub> = 4 mA
	Isolation Resistance	R <sub>1-2</sub>	10 <sup>11</sup>			Ω	V <sub>in-out</sub> = 1.0 kV
	Isolation Capacitance	C <sub>1-2</sub>		0.6		pF	V = 0, f = 1.0 MHz
	Rise Time*4)	t <sub>r</sub>		3		μs	V <sub>CC</sub> = 5 V, I <sub>c</sub> = 2 mA, R <sub>L</sub> = 100 Ω
Fall Time*4)	t <sub>f</sub>		5		μs	V <sub>CC</sub> = 5 V, I <sub>c</sub> = 2 mA, R <sub>L</sub> = 100 Ω	

\*2) PS2625, PS2625L only

\*4) Test Circuit for Switching Time

\*3)  $CTR1 = \frac{I_{c1}}{I_{F1}}$ ,  $CTR2 = \frac{I_{c2}}{I_{F2}}$

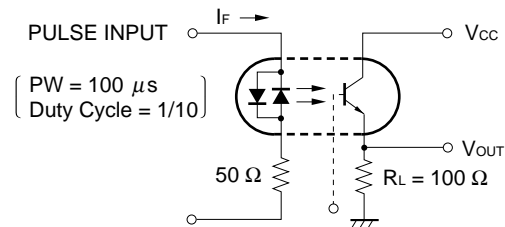
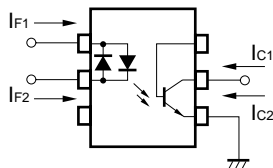

TYPICAL CHARACTERISTICS (T<sub>A</sub> = 25 °C)

DIODE POWER DISSIPATION vs. AMBIENT TEMPERATURE

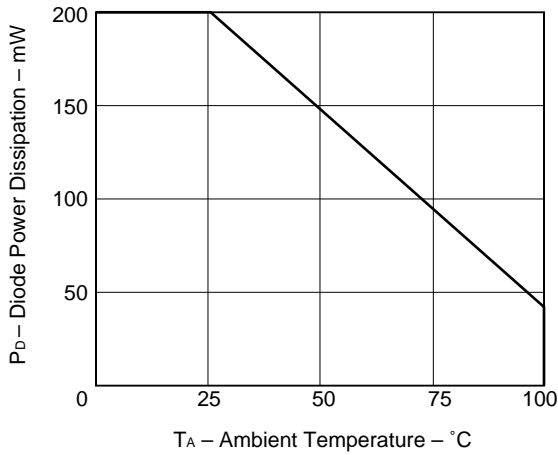

TRANSISTOR POWER DISSIPATION vs. AMBIENT TEMPERATURE

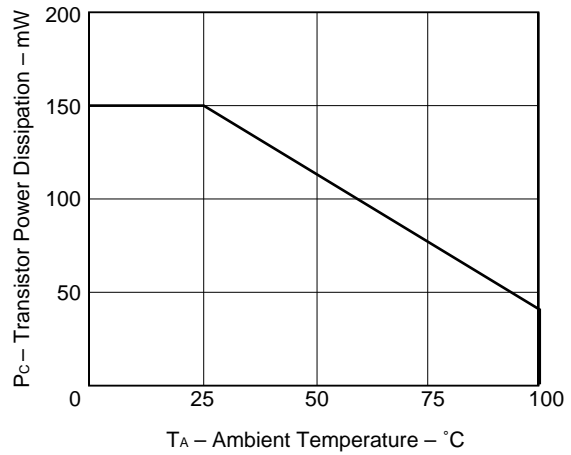

FORWARD CURRENT vs. FORWARD VOLTAGE

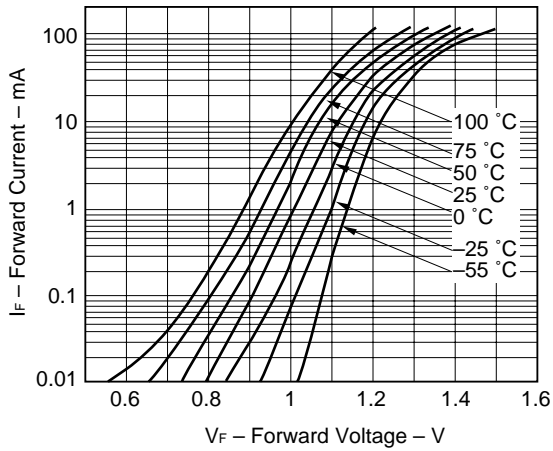

FORWARD CURRENT vs. FORWARD VOLTAGE

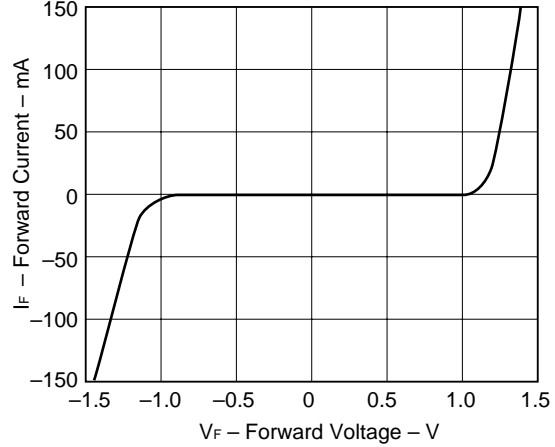

COLLECTOR TO EMITTER DARK CURRENT vs. AMBIENT TEMPERATURE

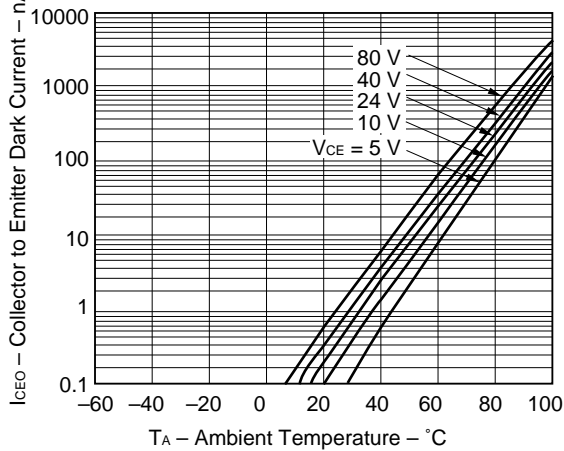

COLLECTOR CURRENT vs. COLLECTOR SATURATION VOLTAGE

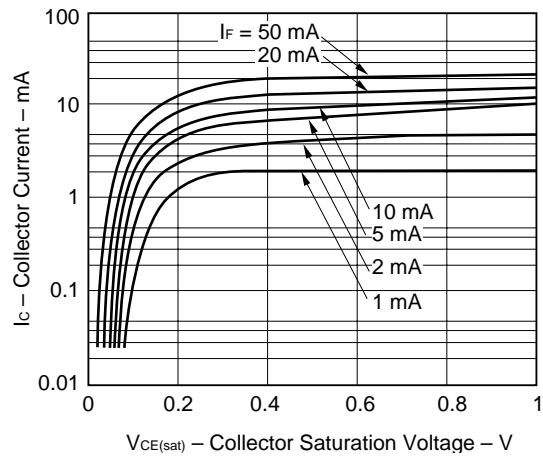

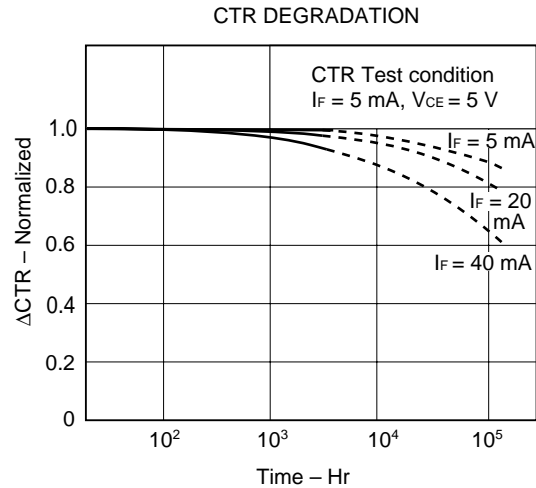
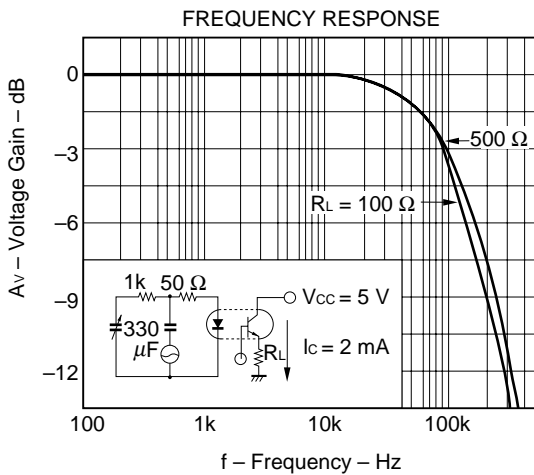
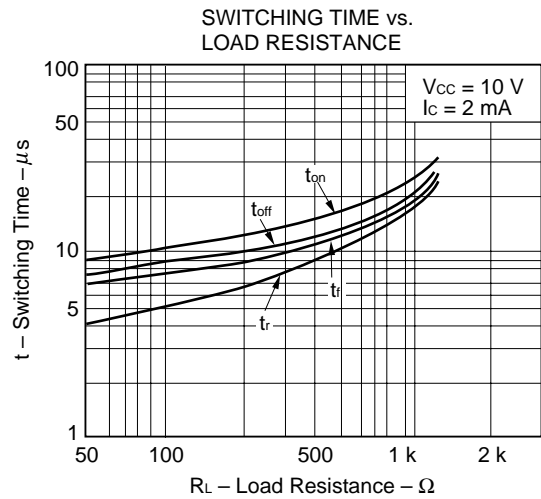
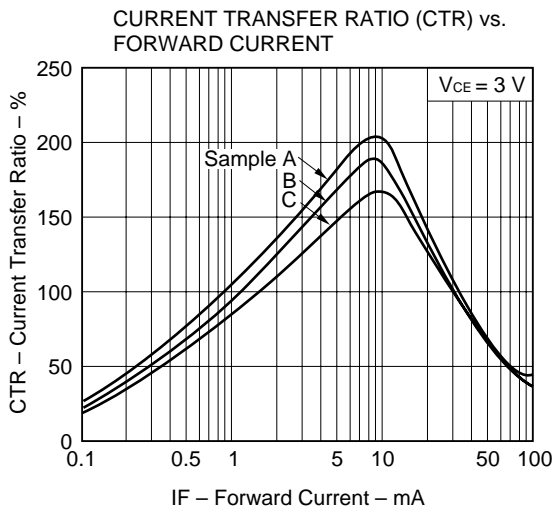
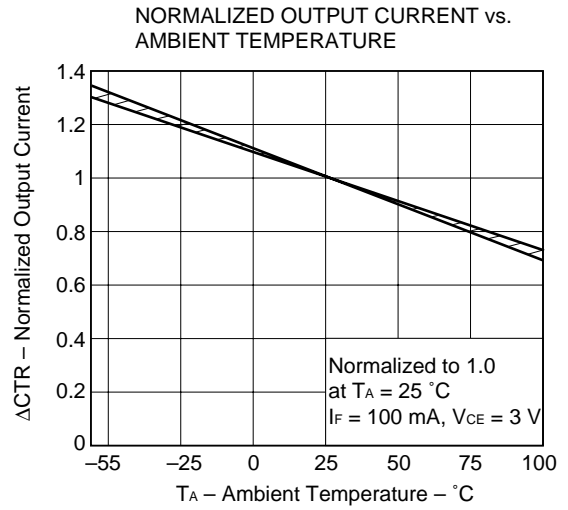
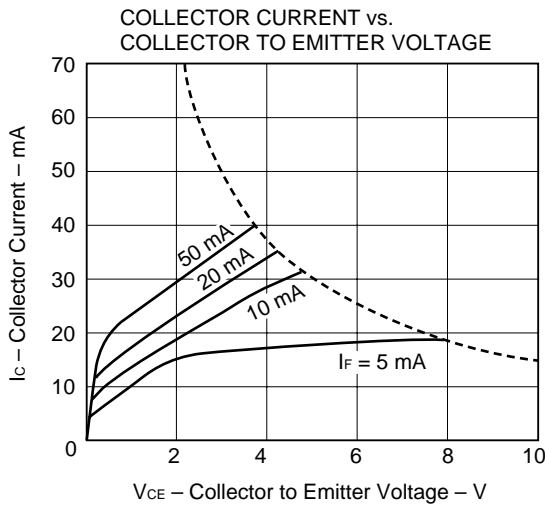

★ The measurement of TYPICAL CHARACTERISTICS are only for reference, not guaranteed.

**SOLDERING PRECAUTION**

(1) Infrared reflow soldering

- Peak reflow temperature : 235 °C or below (Plastic surface temperature)
- Reflow time : 30 seconds or less  
(Time period during which the plastic surface temperature is 210 °C)
- Number of reflow processes : Three
- Flux : Rosin flux containing small amount of chlorine  
(The flux with a maximum chlorine content of 0.2 Wt % is recommended.)

**INFRARED RAY REFLOW TEMPERATURE PROFILE**

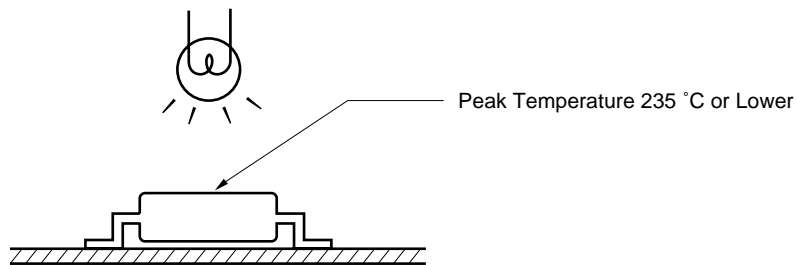
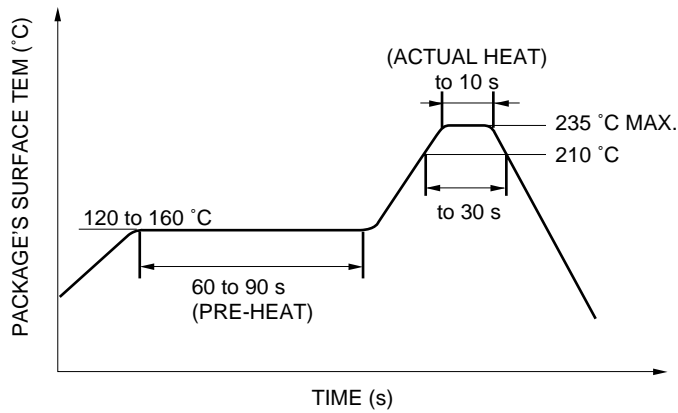

(2) Dip soldering

- Peak temperature : 260 °C or lower
- Time : 10 s or less
- Flux : Rosin-base flux

[MEMO]

## Caution

**The Great Care must be taken in dealing with the devices in this guide.  
The reason is that the material of the devices is GaAs (Gallium Arsenide), which is  
designated as harmful substance according to the law concerned.  
Keep the law concerned and so on, especially in case of removal.**

No part of this document may be copied or reproduced in any form or by any means without the prior written consent of NEC Corporation. NEC Corporation assumes no responsibility for any errors which may appear in this document.

NEC Corporation does not assume any liability for infringement of patents, copyrights or other intellectual property rights of third parties by or arising from use of a device described herein or any other liability arising from use of such device. No license, either express, implied or otherwise, is granted under any patents, copyrights or other intellectual property rights of NEC Corporation or others.

While NEC Corporation has been making continuous effort to enhance the reliability of its semiconductor devices, the possibility of defects cannot be eliminated entirely. To minimize risks of damage or injury to persons or property arising from a defect in an NEC semiconductor device, customer must incorporate sufficient safety measures in its design, such as redundancy, fire-containment, and anti-failure features.

NEC devices are classified into the following three quality grades:

“Standard”, “Special”, and “Specific”. The Specific quality grade applies only to devices developed based on a customer designated “quality assurance program” for a specific application. The recommended applications of a device depend on its quality grade, as indicated below. Customers must check the quality grade of each device before using it in a particular application.

Standard: Computers, office equipment, communications equipment, test and measurement equipment, audio and visual equipment, home electronic appliances, machine tools, personal electronic equipment and industrial robots

Special: Transportation equipment (automobiles, trains, ships, etc.), traffic control systems, anti-disaster systems, anti-crime systems, safety equipment and medical equipment (not specifically designed for life support)

Specific: Aircrafts, aerospace equipment, submersible repeaters, nuclear reactor control systems, life support systems or medical equipment for life support, etc.

The quality grade of NEC devices in “Standard” unless otherwise specified in NEC's Data Sheets or Data Books. If customers intend to use NEC devices for applications other than those specified for Standard quality grade, they should contact NEC Sales Representative in advance.

Anti-radioactive design is not implemented in this product.