

Rectifier diode ultrafast, low switching loss

BYC8B-600

FEATURES

- Extremely fast switching
- Low reverse recovery current
- Low thermal resistance
- Reduces switching losses in associated MOSFET

SYMBOL

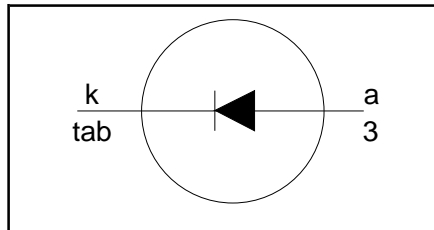

QUICK REFERENCE DATA

$V_R = 600\text{ V}$
$V_F \leq 1.85\text{ V}$
$I_{F(AV)} = 8\text{ A}$
$t_{rr} = 19\text{ ns (typ)}$

APPLICATIONS

- Active power factor correction
- Half-bridge lighting ballasts
- Half-bridge/ full-bridge switched mode power supplies.

The BYC8B-600 is supplied in the SOT404 surface mounting package.

PINNING

PIN	DESCRIPTION
1	no connection
2	cathode ¹
3	anode
tab	cathode

SOT404

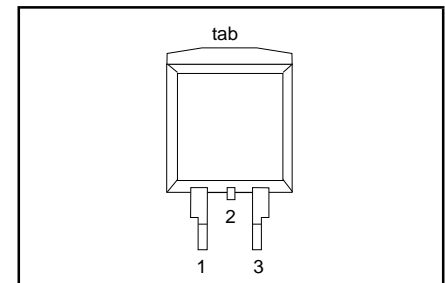

LIMITING VALUES

Limiting values in accordance with the Absolute Maximum System (IEC 134).

SYMBOL	PARAMETER	CONDITIONS	MIN.	MAX.	UNIT
V_{RRM}	Peak repetitive reverse voltage		-	600	V
V_{RWM}	Crest working reverse voltage		-	600	V
V_R	Continuous reverse voltage	$T_{mb} \leq 110\text{ °C}$	-	500	V
$I_{F(AV)}$	Average forward current	$\delta = 0.5$; with reapplied $V_{RRM(max)}$; $T_{mb} \leq 82\text{ °C}^1$	-	8	A
I_{FRM}	Repetitive peak forward current	$\delta = 0.5$; with reapplied $V_{RRM(max)}$; $T_{mb} \leq 82\text{ °C}^1$	-	16	A
I_{FSM}	Non-repetitive peak forward current.	$t = 10\text{ ms}$	-	55	A
		$t = 8.3\text{ ms}$	-	60	A
		sinusoidal; $T_j = 150\text{ °C}$ prior to surge with reapplied $V_{RWM(max)}$			
T_{stg}	Storage temperature		-40	150	°C
T_j	Operating junction temperature		-	150	°C

THERMAL RESISTANCES

SYMBOL	PARAMETER	CONDITIONS	MIN.	TYP.	MAX.	UNIT
$R_{th\ j-mb}$	Thermal resistance junction to mounting base		-	-	2.2	K/W
$R_{th\ j-a}$	Thermal resistance junction to ambient	minimum footprint, FR4 board	-	50	-	K/W

¹ it is not possible to make connection to pin 2 of the SOT404 package

Rectifier diode
ultrafast, low switching loss

BYC8B-600

ELECTRICAL CHARACTERISTICS

$T_j = 25\text{ }^\circ\text{C}$ unless otherwise stated

SYMBOL	PARAMETER	CONDITIONS	MIN.	TYP.	MAX.	UNIT
V_F	Forward voltage	$I_F = 8\text{ A}; T_j = 150\text{ }^\circ\text{C}$	-	1.4	1.85	V
		$I_F = 16\text{ A}; T_j = 150\text{ }^\circ\text{C}$	-	1.7	2.3	V
		$I_F = 8\text{ A}; V_R = 600\text{ V}$	-	2.0	2.8	V
I_R	Reverse current	$V_R = 500\text{ V}; T_j = 100\text{ }^\circ\text{C}$	-	9	150	μA
t_{rr}	Reverse recovery time	$I_F = 8\text{ A to } V_R = 400\text{ V};$ $dI_F/dt = 500\text{ A}/\mu\text{s}$	-	1.1	3.0	ns
t_{rr}	Reverse recovery time	$I_F = 8\text{ A to } V_R = 400\text{ V};$ $dI_F/dt = 500\text{ A}/\mu\text{s}; T_j = 125\text{ }^\circ\text{C}$	-	19	-	ns
I_{rrm}	Peak reverse recovery current	$I_F = 8\text{ A to } V_R = 400\text{ V};$ $dI_F/dt = 500\text{ A}/\mu\text{s}; T_j = 125\text{ }^\circ\text{C}$	-	32	40	ns
V_{fr}	Forward recovery voltage	$I_F = 10\text{ A}; dI_F/dt = 100\text{ A}/\mu\text{s}$	-	9.5	12	A
			-	8	10	V

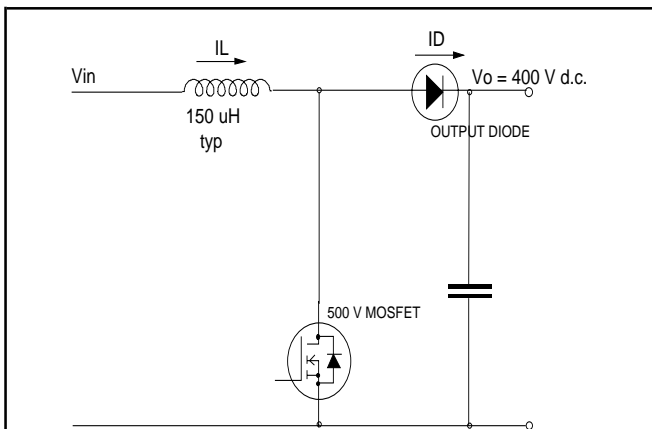

Fig.1. Typical application, output rectifier in boost converter power factor correction circuit. Continuous conduction, mode where the transistor turns on whilst forward current is still flowing in the diode.

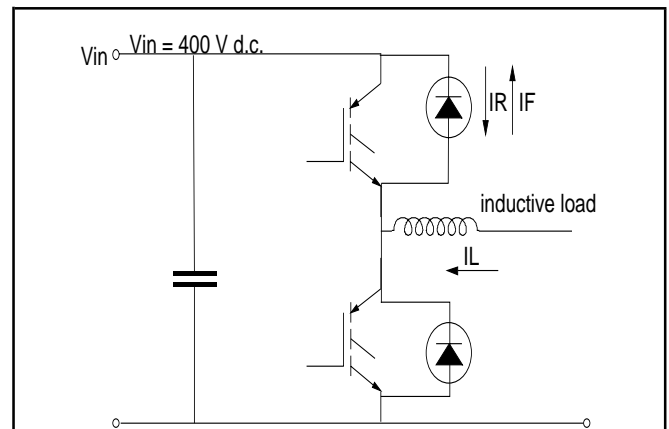
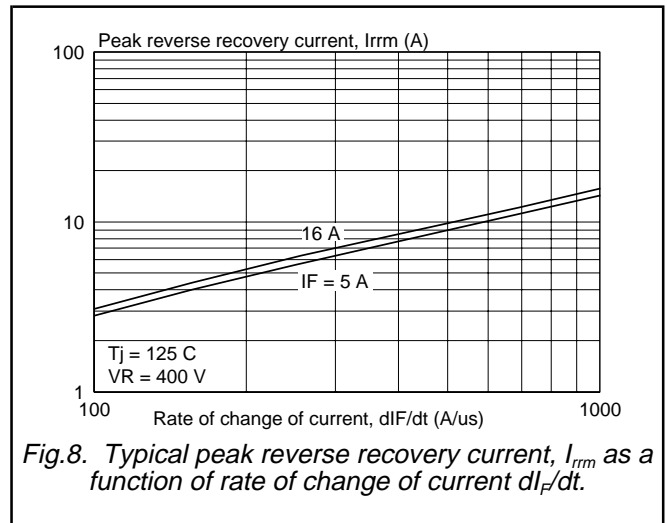
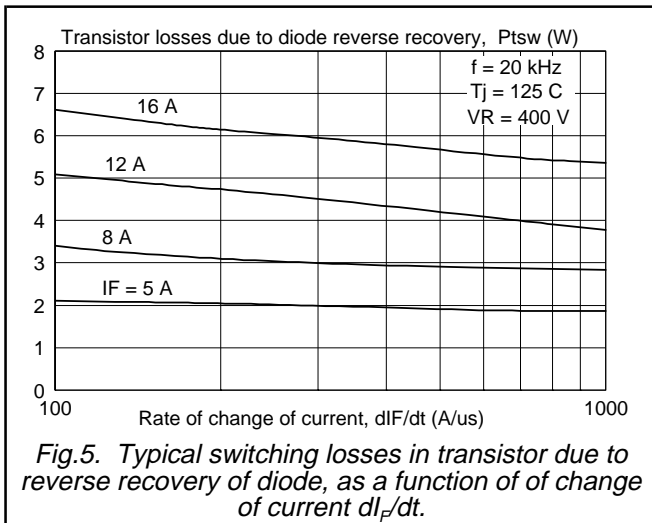
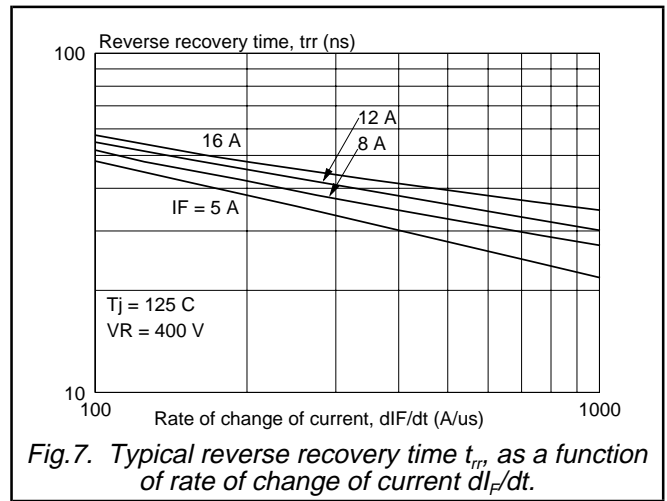
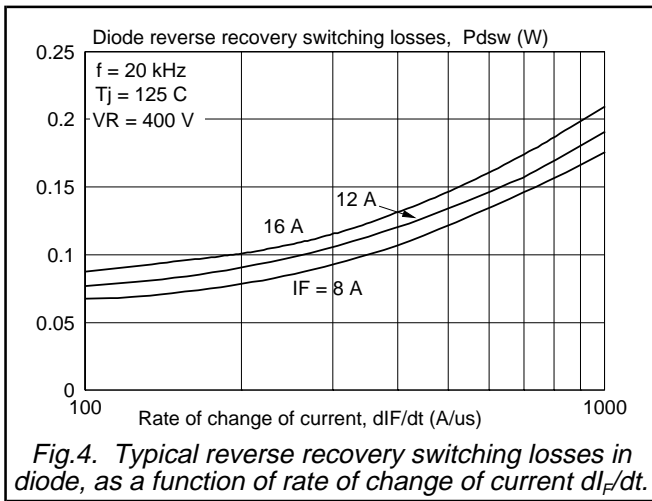
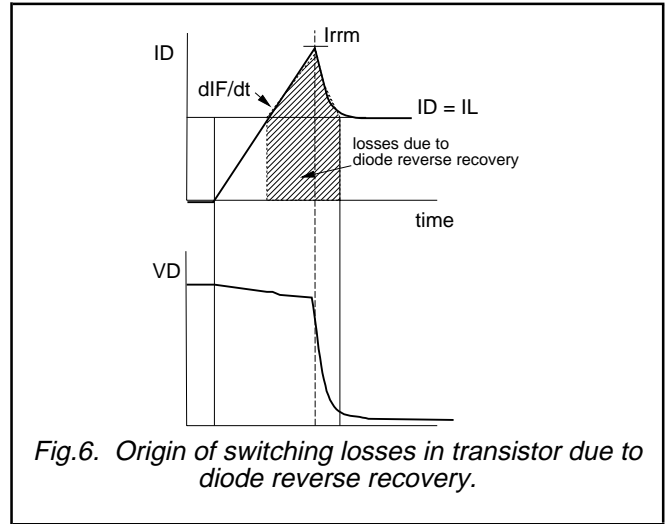
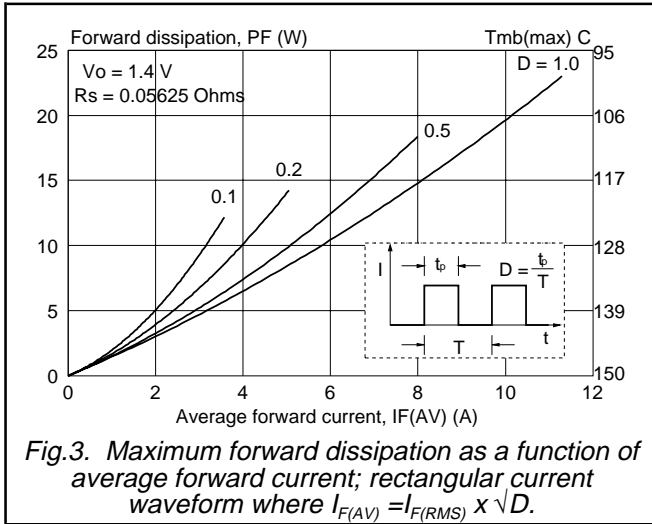

Fig.2. Typical application, freewheeling diode in half bridge converter. Continuous conduction mode, where each transistor turns on whilst forward current is still flowing in the other bridge leg diode.

Rectifier diode
ultrafast, low switching loss

BYC8B-600



Rectifier diode
ultrafast, low switching loss

BYC8B-600

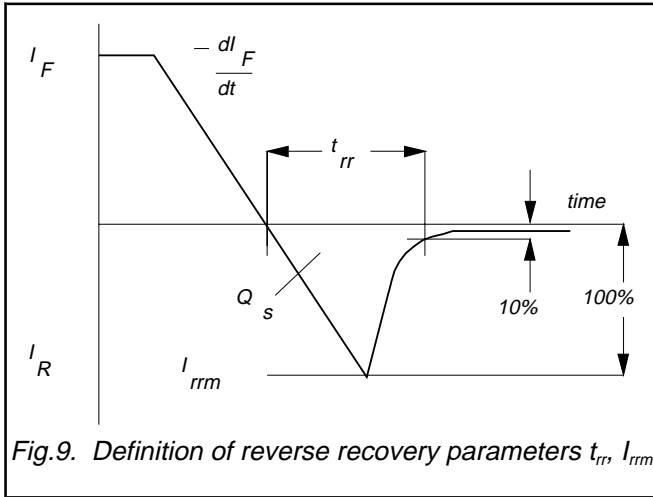

Fig.9. Definition of reverse recovery parameters t_{rr} , I_{rrm}

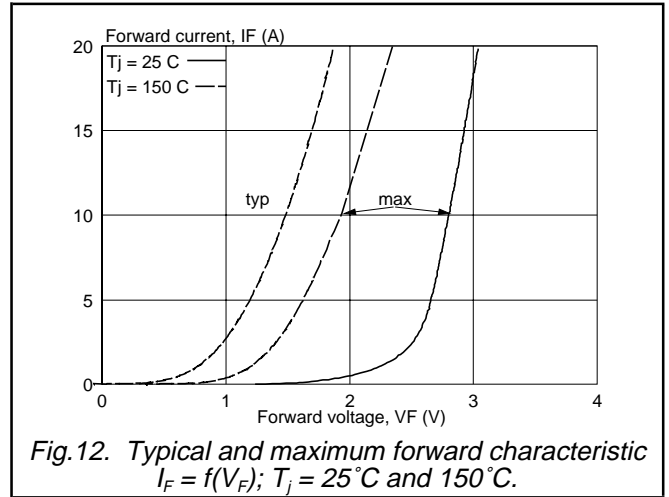

Fig.12. Typical and maximum forward characteristic $I_F = f(V_F)$; $T_j = 25^\circ\text{C}$ and 150°C .

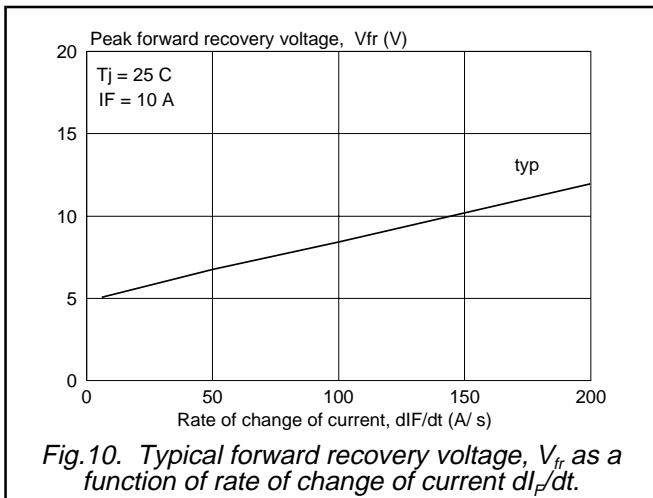

Fig.10. Typical forward recovery voltage, V_{fr} as a function of rate of change of current dl_F/dt .

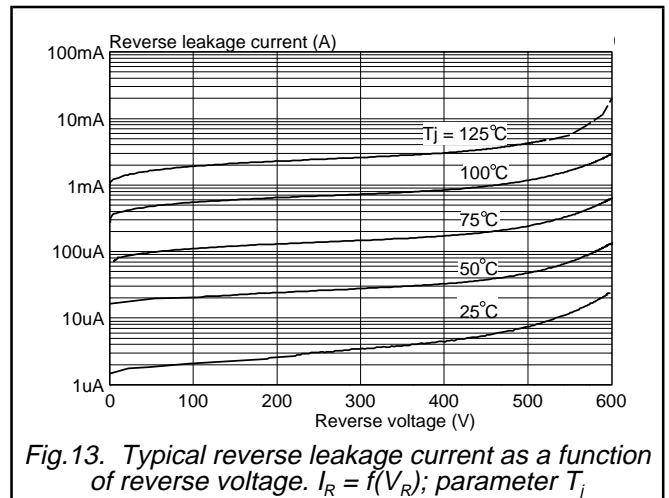

Fig.13. Typical reverse leakage current as a function of reverse voltage. $I_R = f(V_R)$; parameter T_j

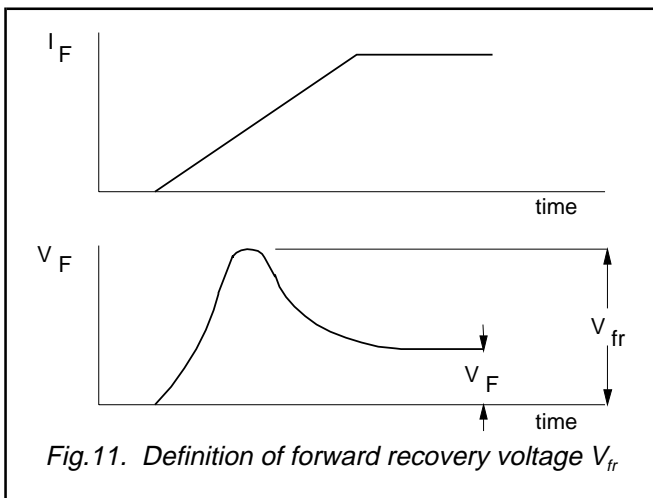

Fig.11. Definition of forward recovery voltage V_{fr}

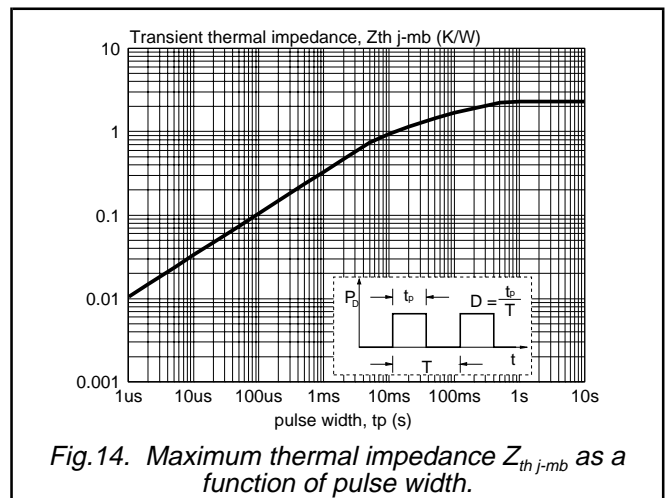
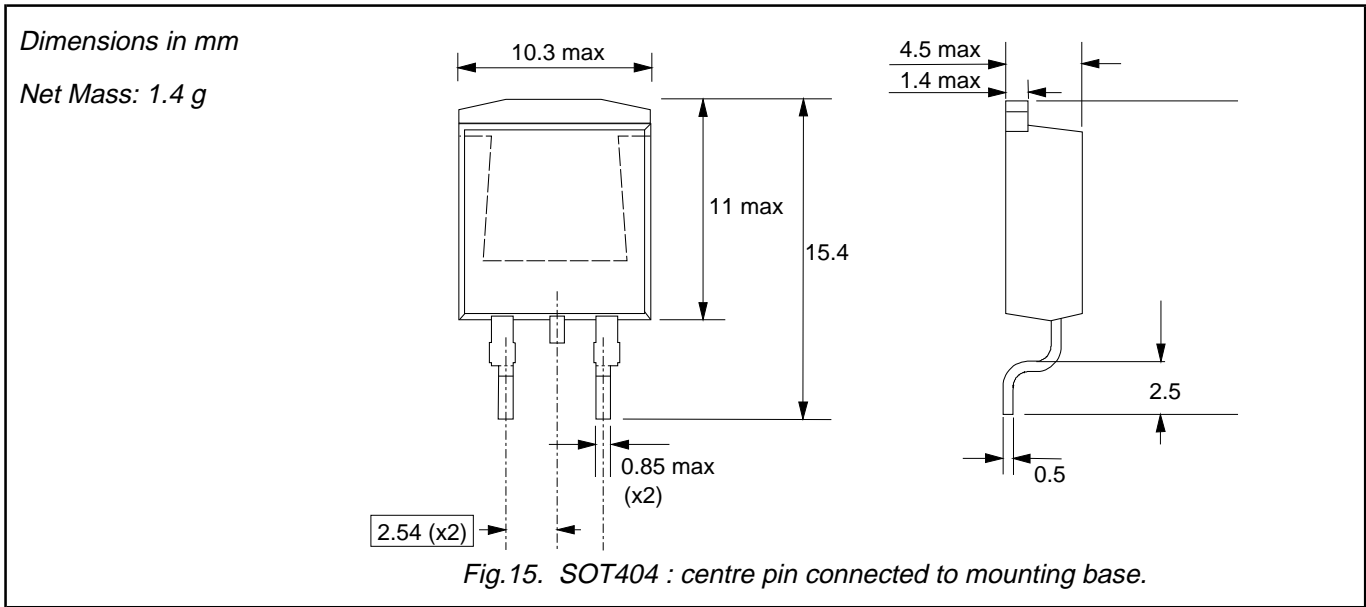

Fig.14. Maximum thermal impedance $Z_{th j-mb}$ as a function of pulse width.

Rectifier diode
ultrafast, low switching loss

BYC8B-600

MECHANICAL DATA



MOUNTING INSTRUCTIONS

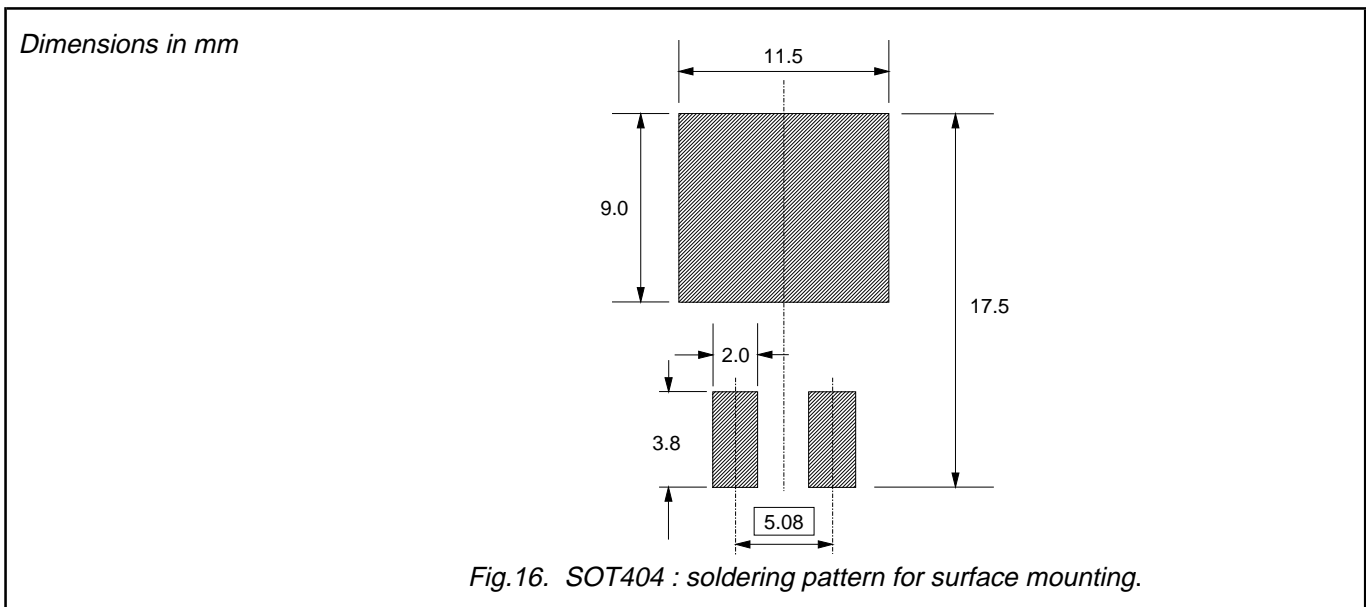

Notes

- 1. Epoxy meets UL94 V0 at 1/8".

Rectifier diode
ultrafast, low switching loss

BYC8B-600**DEFINITIONS**

Data sheet status	
Objective specification	This data sheet contains target or goal specifications for product development.
Preliminary specification	This data sheet contains preliminary data; supplementary data may be published later.
Product specification	This data sheet contains final product specifications.
Limiting values	
Limiting values are given in accordance with the Absolute Maximum Rating System (IEC 134). Stress above one or more of the limiting values may cause permanent damage to the device. These are stress ratings only and operation of the device at these or at any other conditions above those given in the Characteristics sections of this specification is not implied. Exposure to limiting values for extended periods may affect device reliability.	
Application information	
Where application information is given, it is advisory and does not form part of the specification.	
© Philips Electronics N.V. 1998	
All rights are reserved. Reproduction in whole or in part is prohibited without the prior written consent of the copyright owner.	
The information presented in this document does not form part of any quotation or contract, it is believed to be accurate and reliable and may be changed without notice. No liability will be accepted by the publisher for any consequence of its use. Publication thereof does not convey nor imply any license under patent or other industrial or intellectual property rights.	

LIFE SUPPORT APPLICATIONS

These products are not designed for use in life support appliances, devices or systems where malfunction of these products can be reasonably expected to result in personal injury. Philips customers using or selling these products for use in such applications do so at their own risk and agree to fully indemnify Philips for any damages resulting from such improper use or sale.