

EXTRUSION

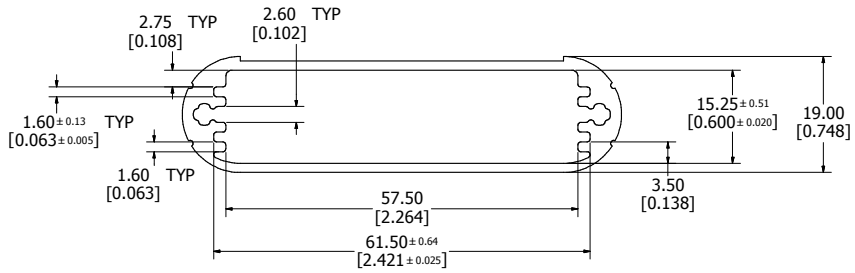

Extrusion designed for 60mm wide x 100mm long PCBs.

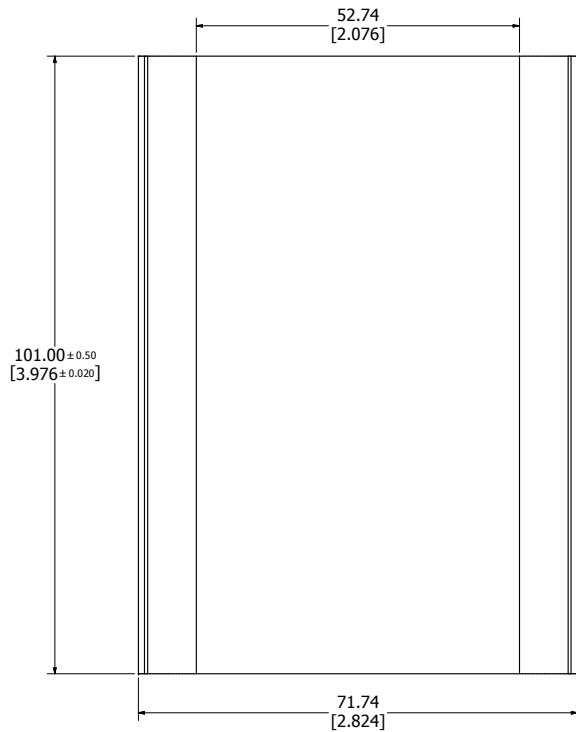

BEZEL

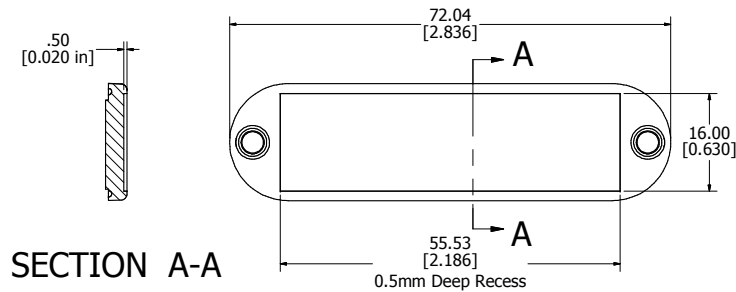

SECTION A-A

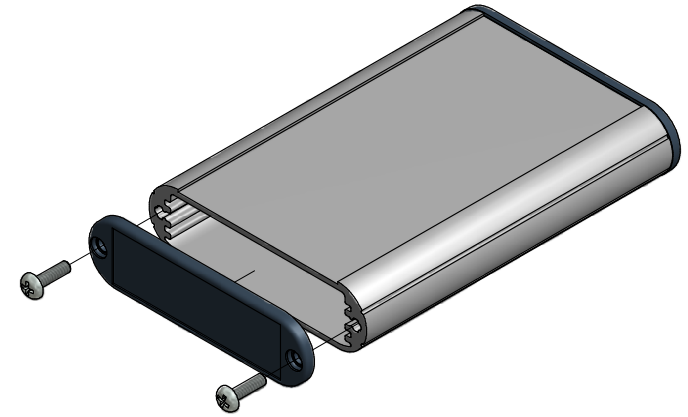
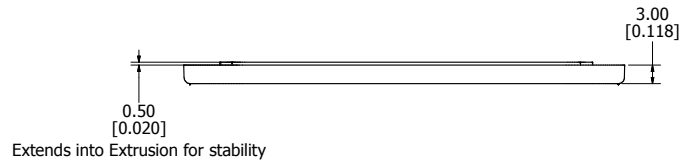

Enclosures can be Factory Modified (Milling, Drilling, Printing etc.)
Solid models of this enclosure available in STEP or IGES.
Contact Factory mjm@hammondmfg.com

NOTE

Purchased assembly includes box, plastic bezels, #6 Taptight screws and self adhesive rubber feet.
Box made from Extruded Aluminum 6063.
Bezels made from polycarbonate.

1455B1002

PART NUMBERS

Clear Anodized	1455B1002
Black Anodized	1455B1002BK

ACCESSORIES

See website for accessories.

