

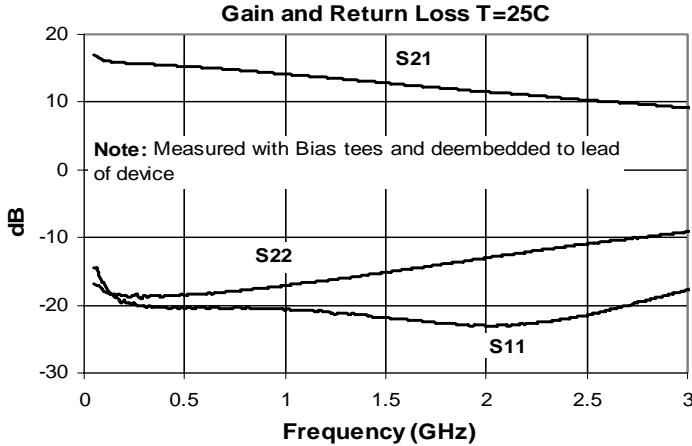

Product Description

Sirenza Microdevices' SXE-1089Z is a high performance pHEMT MMIC amplifier utilizing a patented self-bias Darlington topology housed in a low-cost, surface mountable SOT-89 package. The active bias network provides stable current over temperature and process threshold voltage variations. Designed to run directly from a 5V supply, the SXE-1089Z does not require a dropping resistor as compared to typical Darlington amplifiers. The SXE-1089Z product is designed for high linearity 5V gain block applications that require small size and minimal external components. It is internally matched to 50 ohms.



Preliminary

SXE-1089Z

0.05-3 GHz, Cascadable pHEMT MMIC Amplifier



Product Features

- Excellent ACP -65dBc with 9.5dBm Ch. Pwr. @ 2140 MHz
- OIP3 = 38.5 dBm @ 2140 MHz
- P1dB = 22.6 dBm @ 2140 MHz
- Gain = 11.7 dB @ 1960 MHz
- NF = 3.2 dB @ 1960 MHz
- Single-supply operation: 5V @ Idq=128mA
- Broadband internal matching, no dropping resistor
- Patented Self-Bias Darlington Topology
- Consistent current vs. temperature
- Insensitive to process threshold voltage variation

Applications

- PA Driver Amplifier, Multi-carrier Applications
- GSM, CDMA, TDSCDMA, WCDMA

Symbol	Parameters	Units	Frequency	Min.	Typ.	Max.
S ₂₁	Small Signal Gain	dB	880 MHz		14.2	
			1960 MHz		11.7	
			2140 MHz		11.2	
P _{1dB}	Output Power at 1 dB Compression	dBm	880 MHz		22.4	
			1960 MHz		22.9	
			2140 MHz		22.6	
OIP ₃	Output Third Order Intercept Point 5 dBm per tone, 1MHz spacing	dBm	880 MHz		38.0	
			1960 MHz		38.5	
			2140 MHz		38.5	
ACP	IS-95 Channel Power tested with 9 Channels FWD	-65dBc ACP -45dBc ACP	dBm	880MHz	13.2 17	
	WCDMA Channel Power tested with 64 Channels FWD	-65dBc ACP -45dBc ACP	dBm	2140MHz	9.5 14.5	
S ₁₁	Input Return Loss	dB	2140 MHz		-21.5	
S ₂₂	Output Return Loss	dB	2140 MHz		-23.0	
NF	Noise Figure	dB	2140 MHz		3.2	
V _D	Device Operating Voltage	V			5	
I _D	Device Operating Current	mA			128	
R _{TH, j-l}	Thermal Resistance (junction - lead)	°C/W			45	

Test Conditions: V_D = 5V I_{DQ} = 128mA Typ.
 T_L = 25°C Z_S = Z_L = 50 Ohms Tested with Broadband Application Circuit

The information provided herein is believed to be reliable at press time. Sirenza Microdevices assumes no responsibility for inaccuracies or omissions. Sirenza Microdevices assumes no responsibility for the use of this information, and all such information shall be entirely at the user's own risk. Prices and specifications are subject to change without notice. No patent rights or licenses to any of the circuits described herein are implied or granted to any third party. Sirenza Microdevices does not authorize or warrant any Sirenza Microdevices product for use in life-support devices and/or systems. Copyright 2005 Sirenza Microdevices, Inc.. All worldwide rights reserved.

Typical RF Performance at Key Operating Frequencies (with Broadband Application Circuit)

Symbol	Parameter	Unit	Frequency (MHz)						
			500	880	1570	1960	2140	2440	3000
S ₂₁	Small Signal Gain	dB	14.7	14.2	12.6	11.7	11.2	10.5	9.1
OIP ₃	Output Third Order Intercept Point 5 dBm per tone, 1MHz spacing	dBm	38	38	38.5	38.5	38.5	38.5	37
ACP ¹	Channel Power at -65dBc	dBm		13.2			9.5		
P _{1dB}	Output Power at 1dB Compression	dBm	20.6	22.4	23	22.9	22.6	22.3	21.3
S ₁₁	Input Return Loss	dB	-23.5	-13.5	-15.5	-19	-21.5	-31.5	-23
S ₂₂	Output Return Loss	dB	-9	-13	-19.5	-24	-23	-18.5	-13
S ₁₂	Reverse Isolation	dB	-21	-20	-18.5	-18	-17.5	-17	-16
NF	Noise Figure	dB	3.2	3.2	3.2	3.2	3.2	3.2	3.4

Test Conditions: V_D = 5V I_{DQ} = 128mA Typ. ACP¹ = 880MHz tested with IS-95 9 Ch. FWD
T_L = 25°C Z_S = Z_L = 50 Ohms 2140MHz tested with WCDMA 64 Ch. FWD

Note: OIP3 can be improved to 39-40 dBm by lowering the output choke and/or increasing the output DC block. These changes will reduce P1dB and ACP

Absolute Maximum Ratings	
Parameter	Absolute Limit
Max Device Current (I _D)	170mA
Max Device Voltage (V _D)	5.5V
Max. RF Input Power* (See Note)	25dBm
Max. Junction Temp. (T _J)	+150°C
Operating Temp. Range (T _L)	-40°C to +85°C
Max. Storage Temp.	+150°C

***Note:** Load condition, Z_L = 50 Ohms
Operation of this device beyond any one of these limits may cause permanent damage. For reliable continuous operation, the device voltage and current must not exceed the maximum operating values specified in the table on page one.
Bias Conditions should also satisfy the following expression:
 $I_D V_D < (T_J - T_L) / R_{TH}, j-l \quad T_L = T_{LEAD}$

Reliability & Qualification Information	
Parameter	Rating
ESD Rating - Human Body Model (HBM)	Class 1B
Moisture Sensitivity Level	MSL1

This product qualification report can be downloaded at
www.sirenza.com



Caution: ESD sensitive
Appropriate precautions in handling, packaging and testing devices must be observed.

Typical RF Performance (with Broadband Application Circuit)

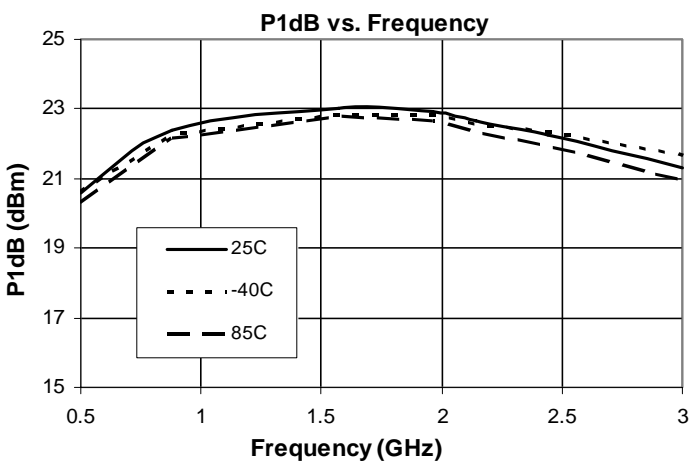
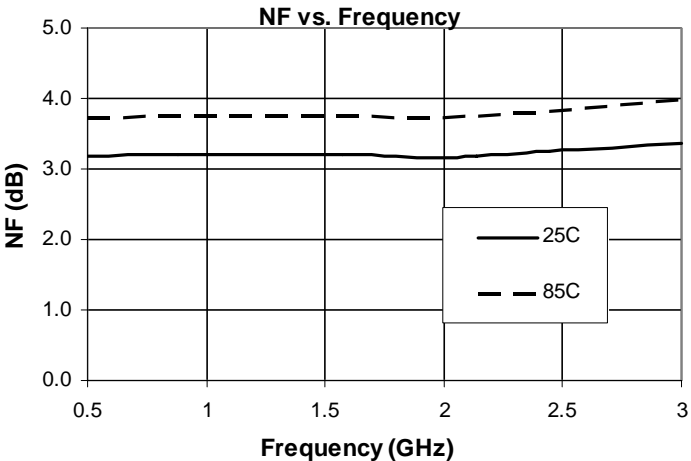

Typical RF Performance (with Broadband Application Circuit)

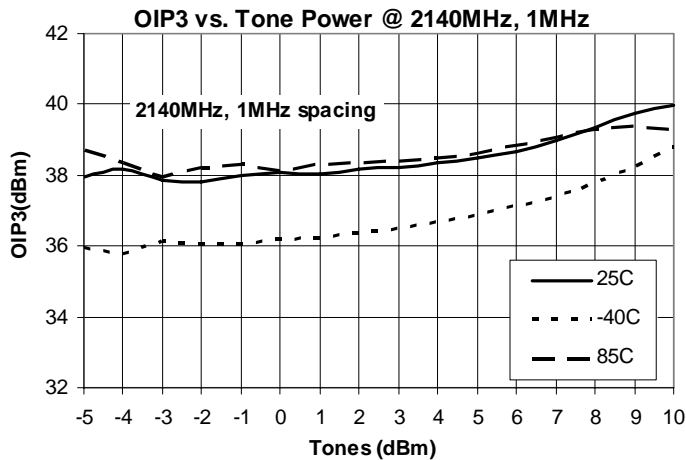
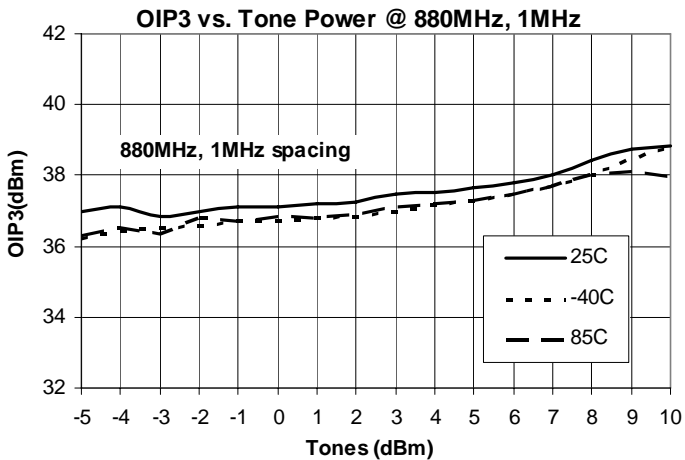
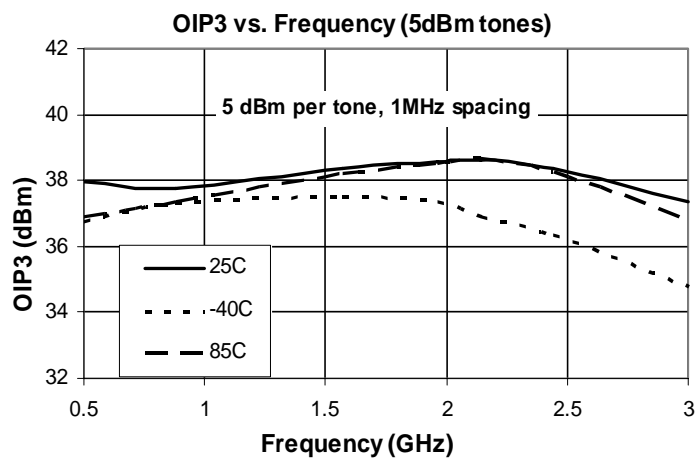
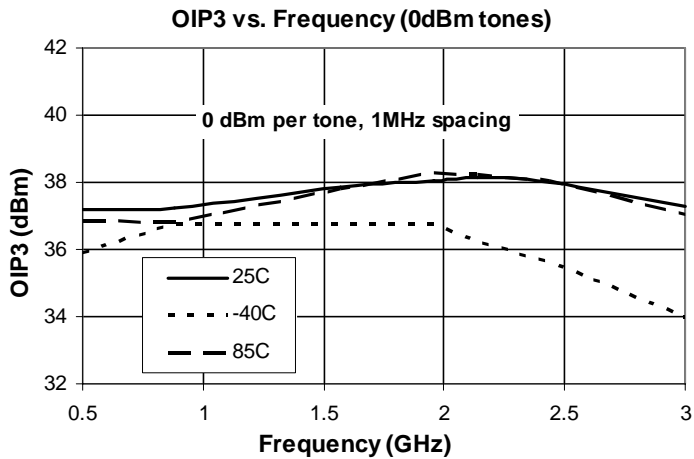
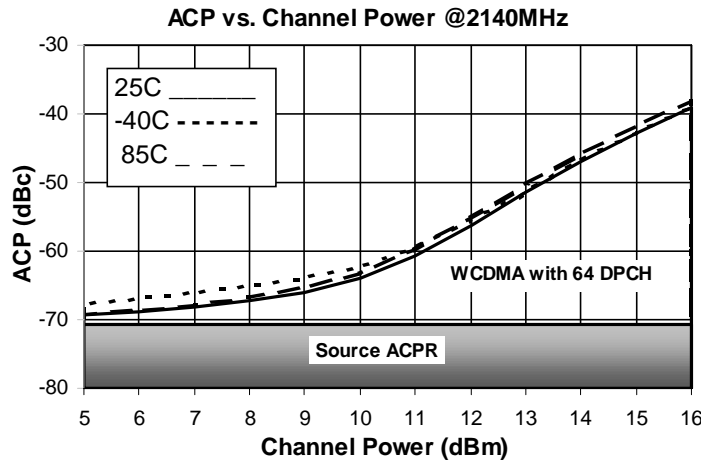
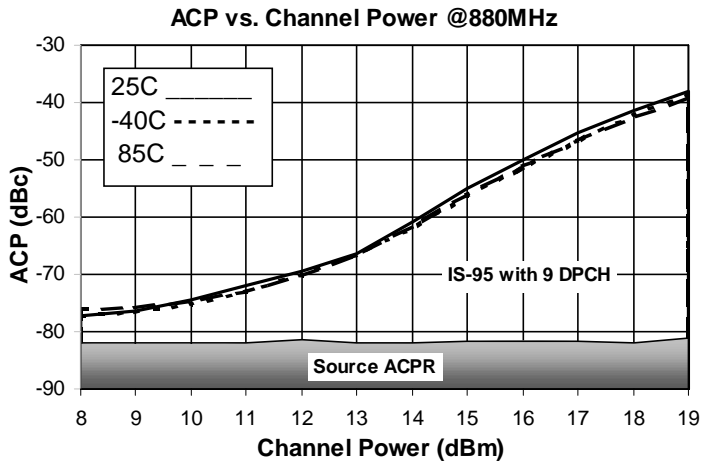

S-Parameters over Temperature (with Broadband Application Circuit)

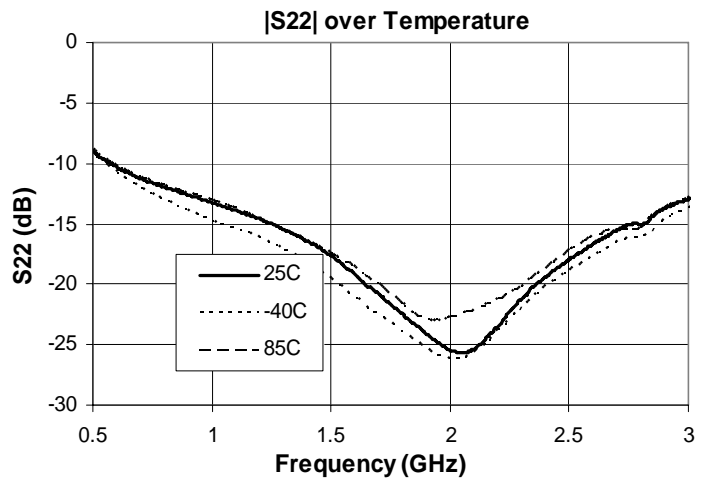
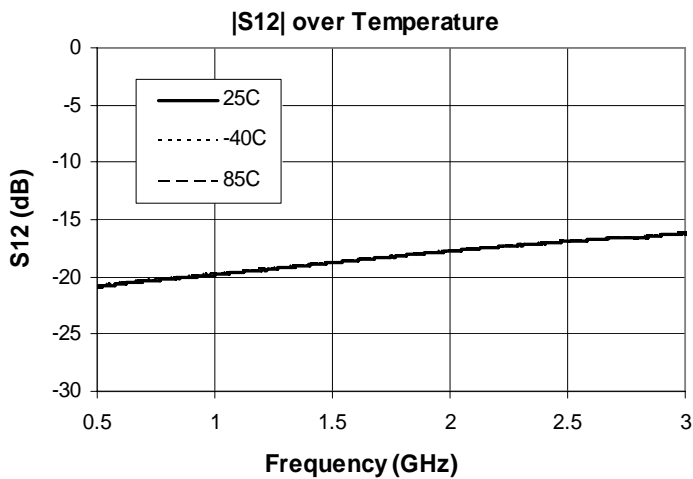
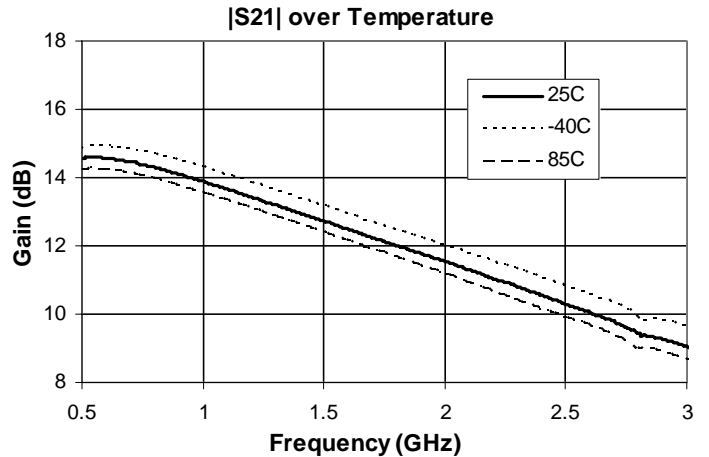
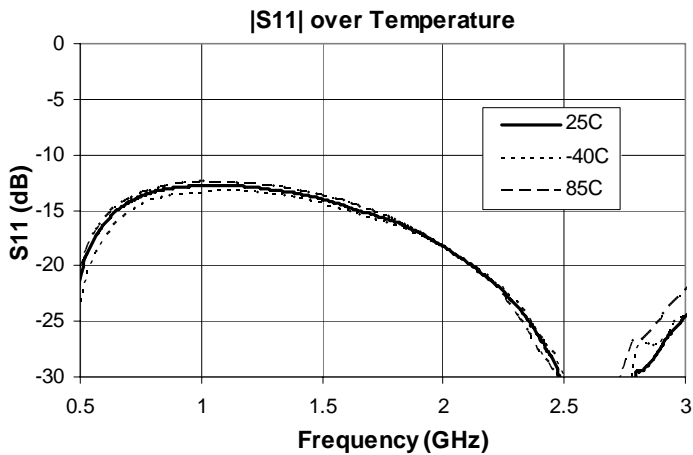

Device Current over Temperature

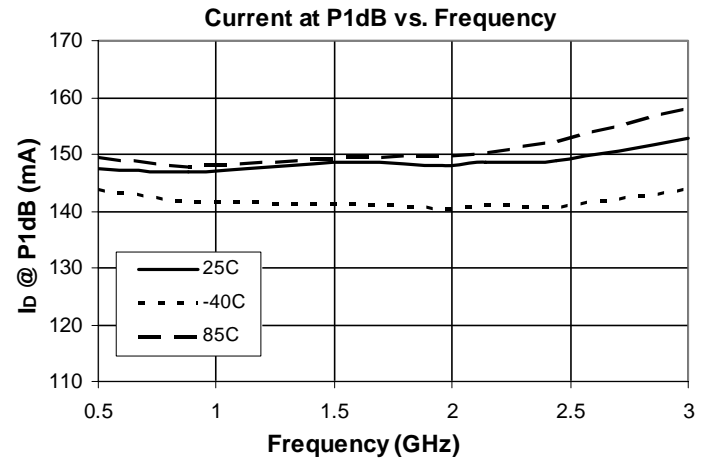
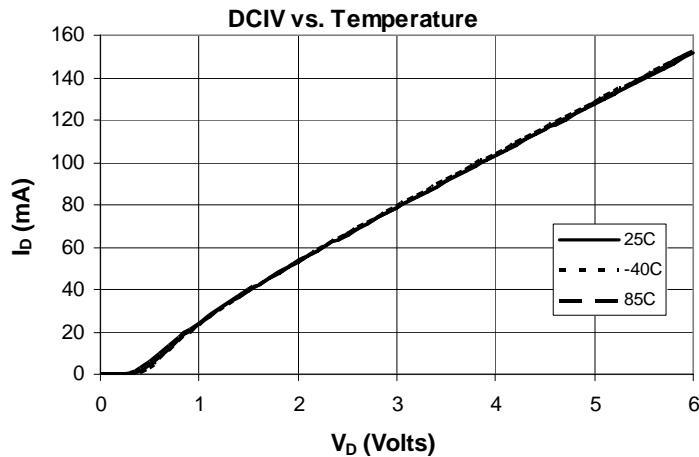

Typical Performance - De-embedded S-parameters

Note: S-parameters are de-embedded to the device leads with $Z_S=Z_L=50\Omega$. The device was mounted on Sirenza's recommended evaluation board. De-embedded S-parameters can be downloaded from our website (www.sirenza.com)

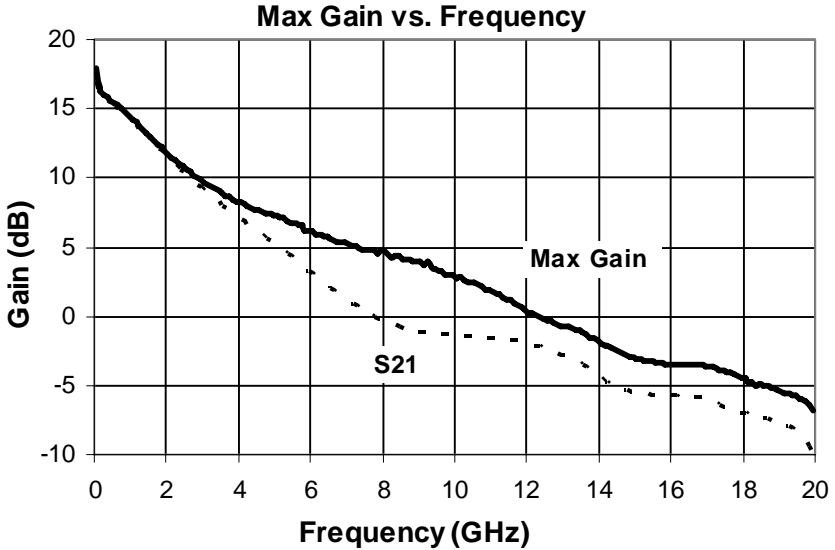

S11 Vs. Frequency

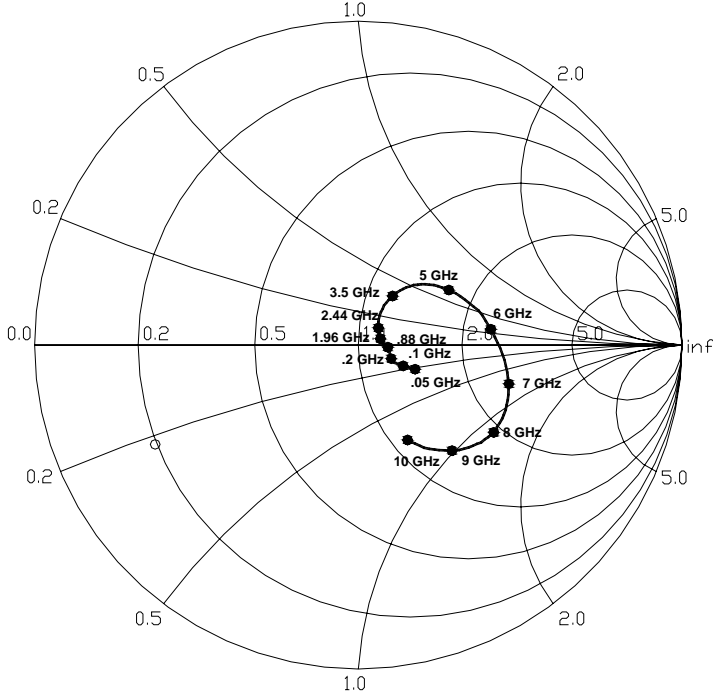

S22 Vs. Frequency

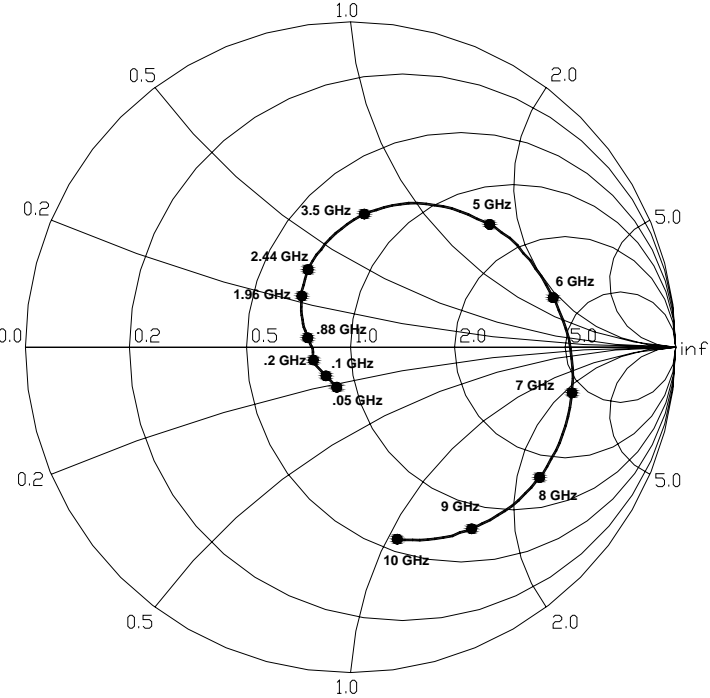

Broadband Application Schematic (500 - 2500MHz)

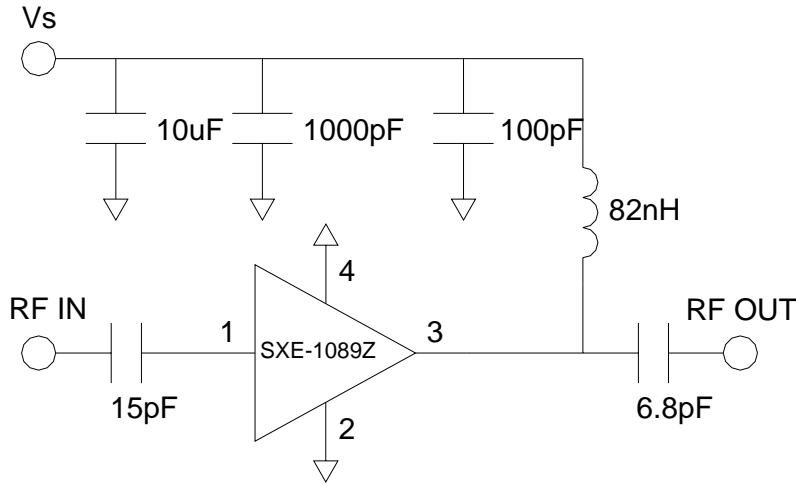

Part Identification Marking & Pinout

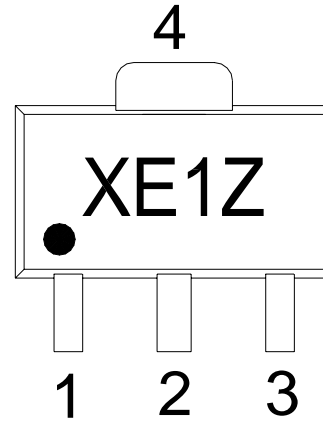

Evaluation Board Layout

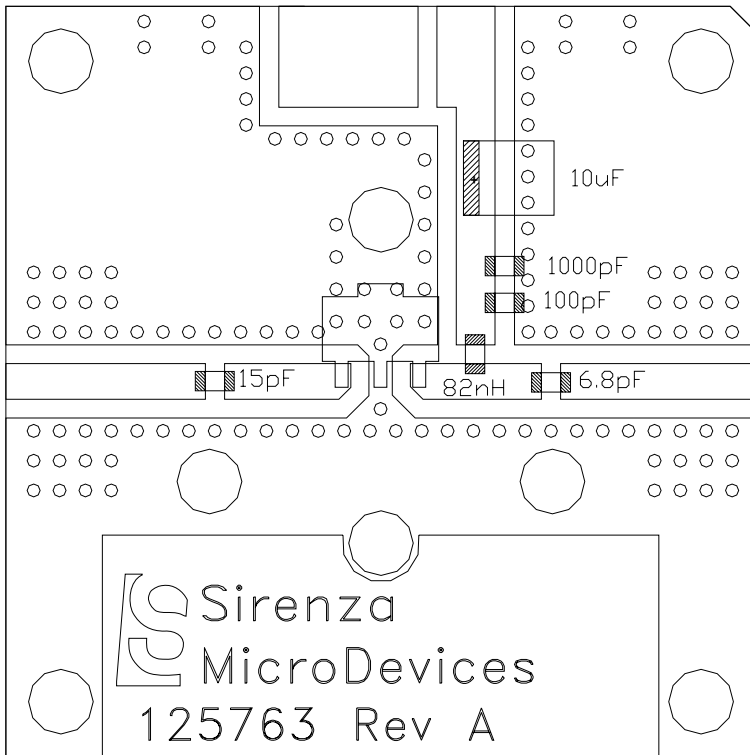

Pin #	Function	Description
1	RF IN	RF input pin. This pin requires the use of an external DC blocking capacitor chosen for the frequency of operation.
2, 4	GND	Connection to ground. Use via holes for best performance to reduce lead inductance as close to ground leads as possible
3	RF OUT/ BIAS	RF output and bias pin. DC voltage is present on this pin, therefore a DC blocking capacitor is necessary for proper operation.

Mounting Instructions

1. Solder the copper pad on the backside of the device package to the ground plane.
2. Use a large ground pad area with many plated through-holes as shown.
3. We recommend 1 or 2 ounce copper. Measurements for this data sheet were made on a 31 mil thick FR-4 board with 1 ounce copper on both sides.

Part Number Ordering Information

Part Number	Reel Size	Devices / Reel
SXE-1089Z	7"	1000

Suggested PCB Pad Layout
 Dimensions in inches [millimeters]

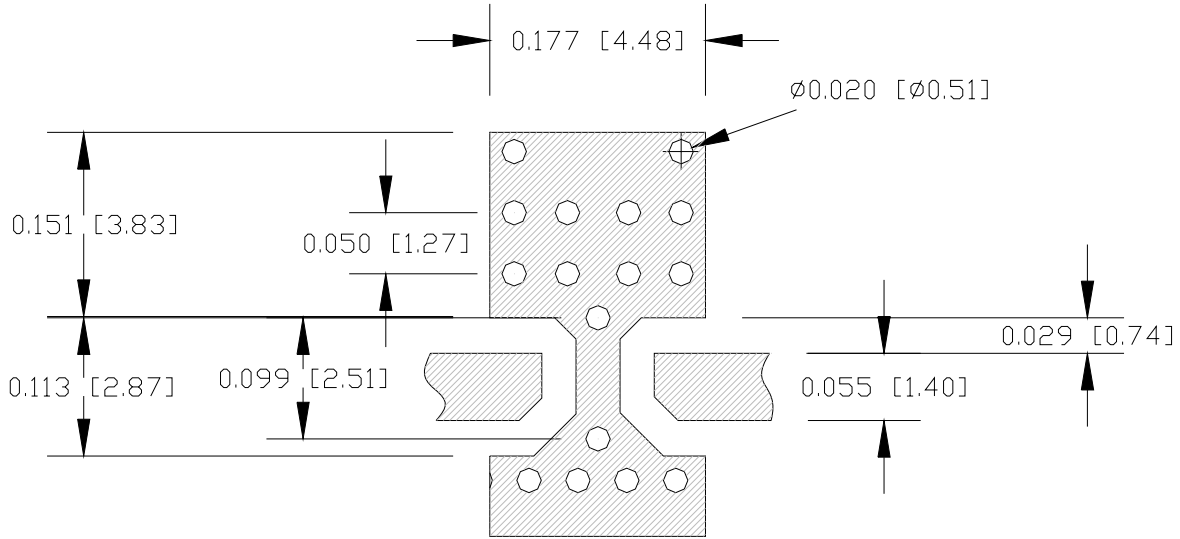

Nominal Package Dimensions

Dimensions in inches (millimeters)
 Refer to package drawing posted at www.sirenza.com for tolerances

Bottom View

Package Type: SOT- 89

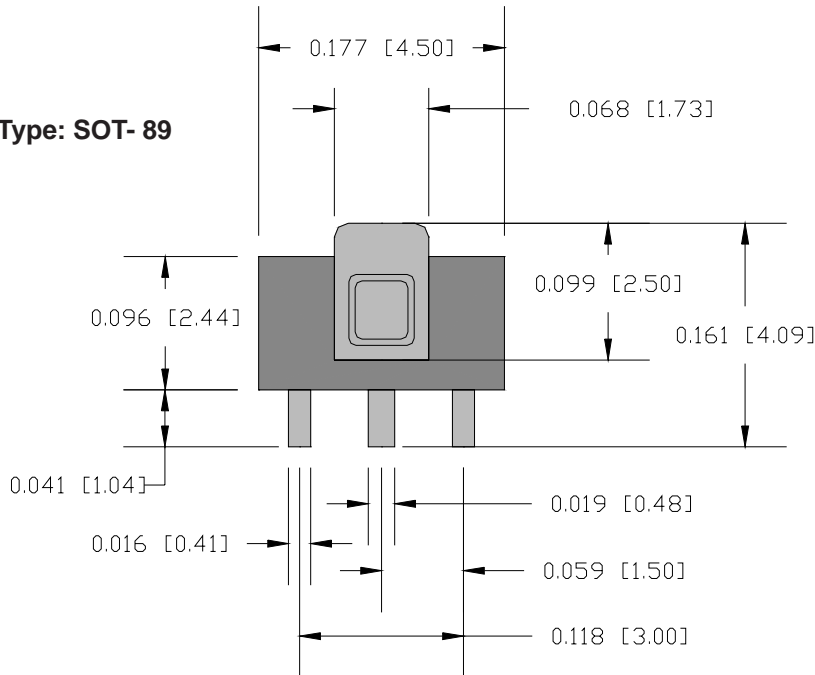

Side View

