

## CHIP COIL (CHIP INDUCTORS) LQG15HS□□□□02D REFERENCE SPECIFICATION

### 1. Scope

This reference specification applies to LQG15HS\_02 series, for Chip Coil (Chip Inductors).

### 2. Part Numbering

(ex) LQ G 15 H S 1N0 S 0 2 D  
 Product ID Structure Dimension Applications Category Inductance Tolerance Features Electrode Packaging  
 (L×W) and Characteristics D:Taping \*B:BULK

\*Bulk packing (B) also available

### 3. Rating

•Operating Temperature Range  $-55^{\circ}\text{C}$  to  $+125^{\circ}\text{C}$

•Storage Temperature Range  $-55^{\circ}\text{C}$  to  $+125^{\circ}\text{C}$

Customer Part Number	MURATA Part Number	Inductance (nH)	Tolerance	Q (min.)	DC Resistance ( $\Omega$ max.)	Self Resonant Frequency (MHz min.)	Rated Current (mA)
	LQG15HS1N0B02D	1.0	B:±0.1nH C:±0.2nH S:±0.3nH	8	0.07	10000	
	LQG15HS1N0C02D						
	LQG15HS1N0S02D						
	LQG15HS1N1B02D	1.1					
	LQG15HS1N1C02D						
	LQG15HS1N1S02D						
	LQG15HS1N2B02D	1.2					
	LQG15HS1N2C02D						
	LQG15HS1N2S02D						
	LQG15HS1N3B02D	1.3					
	LQG15HS1N3C02D						
	LQG15HS1N3S02D						
	LQG15HS1N5B02D	1.5					
	LQG15HS1N5C02D						
	LQG15HS1N5S02D						
	LQG15HS1N6B02D	1.6					
	LQG15HS1N6C02D						
	LQG15HS1N6S02D						
	LQG15HS1N8B02D	1.8					
	LQG15HS1N8C02D						
	LQG15HS1N8S02D						
	LQG15HS2N0B02D	2.0					
	LQG15HS2N0C02D						
	LQG15HS2N0S02D						
	LQG15HS2N2B02D	2.2					
	LQG15HS2N2C02D						
	LQG15HS2N2S02D						
	LQG15HS2N4B02D	2.4					
	LQG15HS2N4C02D						
	LQG15HS2N4S02D						
	LQG15HS2N7B02D	2.7					
	LQG15HS2N7C02D						
	LQG15HS2N7S02D						
	LQG15HS3N0B02D	3.0					
	LQG15HS3N0C02D						
	LQG15HS3N0S02D						
	LQG15HS3N3B02D	3.3					
	LQG15HS3N3C02D						
	LQG15HS3N3S02D						
	LQG15HS3N6B02D	3.6					
	LQG15HS3N6C02D						
	LQG15HS3N6S02D						

Customer Part Number	MURATA Part Number	Inductance (nH)	Tolerance	Q (min.)	DC Resistance ( $\Omega$ max.)	Self Resonant Frequency (MHz min.)	Rated Current (mA)
	LQG15HS3N9B02D	3.9	B: $\pm 0.1$ nH C: $\pm 0.2$ nH S: $\pm 0.3$ nH	8	0.14	6000	750
	LQG15HS3N9C02D						
	LQG15HS3N9S02D						
	LQG15HS4N3B02D	4.3					
	LQG15HS4N3C02D						
	LQG15HS4N3S02D						
	LQG15HS4N7B02D	4.7					
	LQG15HS4N7C02D						
	LQG15HS4N7S02D						
	LQG15HS5N1B02D	5.1					
	LQG15HS5N1C02D						
	LQG15HS5N1S02D						
	LQG15HS5N6B02D	5.6					
	LQG15HS5N6C02D						
	LQG15HS5N6S02D						
	LQG15HS6N2B02D	6.2					
	LQG15HS6N2C02D						
	LQG15HS6N2S02D						
	LQG15HS6N8G02D	6.8					
	LQG15HS6N8H02D						
	LQG15HS6N8J02D						
	LQG15HS7N5G02D	7.5					
	LQG15HS7N5H02D						
	LQG15HS7N5J02D						
	LQG15HS8N2G02D	8.2					
	LQG15HS8N2H02D						
	LQG15HS8N2J02D						
	LQG15HS9N1G02D	9.1					
	LQG15HS9N1H02D						
	LQG15HS9N1J02D						
	LQG15HS10NG02D	10					
	LQG15HS10NH02D						
	LQG15HS10NJ02D						
	LQG15HS12NG02D	12					
	LQG15HS12NH02D						
	LQG15HS12NJ02D						
	LQG15HS15NG02D	15					
	LQG15HS15NH02D						
	LQG15HS15NJ02D						
	LQG15HS18NG02D	18					
	LQG15HS18NH02D						
	LQG15HS18NJ02D						
	LQG15HS22NG02D	22					
	LQG15HS22NH02D						
	LQG15HS22NJ02D						
	LQG15HS27NG02D	27					
	LQG15HS27NH02D						
	LQG15HS27NJ02D						
	LQG15HS33NG02D	33					
	LQG15HS33NH02D						
	LQG15HS33NJ02D						
	LQG15HS39NG02D	39					
	LQG15HS39NH02D						
	LQG15HS39NJ02D						
			G: $\pm 2\%$ H: $\pm 3\%$ J: $\pm 5\%$				

Customer Part Number	MURATA Part Number	Inductance (nH)	Tolerance	Q (min.)	DC Resistance ( $\Omega$ max.)	Self Resonant Frequency (MHz min.)	Rated Current (mA)
	LQG15HS47NG02D	47	G: $\pm$ 2% H: $\pm$ 3% J: $\pm$ 5%	8	0.72	1000	300
	LQG15HS47NH02D						
	LQG15HS47NJ02D						
	LQG15HS56NG02D	56			0.82	800	250
	LQG15HS56NH02D						
	LQG15HS56NJ02D						
	LQG15HS68NG02D	68			0.92	800	250
	LQG15HS68NH02D						
	LQG15HS68NJ02D						
	LQG15HS82NG02D	82			1.20	700	200
	LQG15HS82NH02D						
	LQG15HS82NJ02D						
	LQG15HSR10G02D	100			1.25	600	
	LQG15HSR10H02D						
	LQG15HSR10J02D						
	LQG15HSR12G02D	120			1.30	150	
	LQG15HSR12H02D						
	LQG15HSR12J02D						
	LQG15HSR15G02D	150			2.99	550	
	LQG15HSR15H02D						
	LQG15HSR15J02D						
	LQG15HSR18G02D	180			3.38	500	
	LQG15HSR18H02D						
	LQG15HSR18J02D						
	LQG15HSR22G02D	220	3.77	450	120		
	LQG15HSR22H02D						
	LQG15HSR22J02D						
	LQG15HSR27G02D	270	4.94	400	110		
	LQG15HSR27H02D						
	LQG15HSR27J02D						

#### 4. Testing Conditions

《Unless otherwise specified》

Temperature : Ordinary Temperature / 15°C to 35°C  
 Humidity : Ordinary Humidity / 25%(RH) to 85%(RH)

《In case of doubt》

Temperature : 20°C  $\pm$  2°C  
 Humidity : 60%(RH) to 70%(RH)  
 Atmospheric Pressure : 86kPa to 106 kPa

#### 5. Appearance and Dimensions

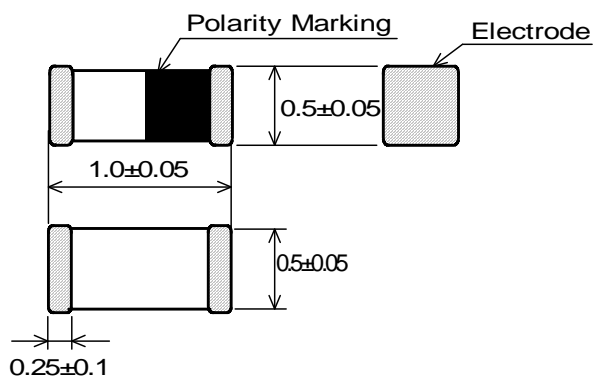

■ Unit Mass (Typical value)  
0.001g

(in mm)

## 6. Electrical Performance

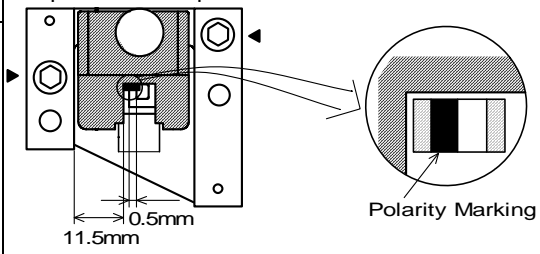
No.	Item	Specification	Test Method
6.1	Inductance	Inductance shall meet item 3.	Measuring Equipment: Agilent 4291A or equivalent Measuring Frequency: 100MHz Measuring Condition: Test signal level/ about 7dBm Electrical length/ 0.94cm Weight/ about 1N to 5N Measuring Fixture: Agilent 16193A Position coil under test as shown in below and contact coil with each terminal by adding weight. Polarity marking should be a topside, and polarity marking should be in the direction of the fixture for position of chip coil.
6.2	Q	Q shall meet item 3.	 Measuring Method: See P.11 [Electrical Performance: Measuring Method of Inductance/ Q]
6.3	DC Resistance	DC Resistance shall meet item 3.	Measuring Equipment: Digital multi meter
6.4	Self Resonant Frequency (S.R.F)	S.R.F shall meet item 3.	Measuring Equipment: Agilent 8753C or equivalent
6.5	Rated Current	Self temperature rise shall be limited to 25°C max.	The rated current is applied.

## 7. Mechanical Performance

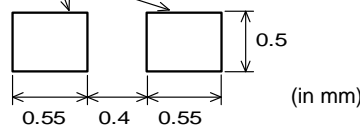
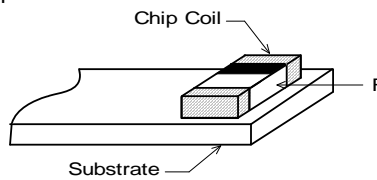
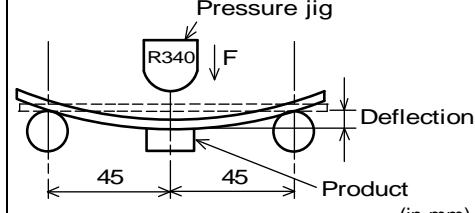
No.	Item	Specification	Test Method
7.1	Shear Test	Chip coil shall not be damaged after tested as test method.	Substrate: Glass-epoxy substrate  Force: 5N Hold Duration: 5s±1s Applied Direction: Parallel to PCB 
7.2	Bending Test	Chip coil shall not be damaged after tested as test method.	Substrate: Glass-epoxy substrate (100mm × 40mm × 0.8mm) Speed of Applying Force: 1mm / s Deflection: 2mm Hold Duration: 30s 

No.	Item	Specification	Test Method
7.3	Vibration	Appearance: No damage Inductance Change: within $\pm 10\%$	Oscillation Frequency: 10Hz to 55Hz to 10Hz for 1 min Total Amplitude: 1.5mm Testing Time: A period of 2 hours in each of 3 mutually perpendicular directions.
7.4	Solderability	The wetting area of the electrode shall be at least 90% covered with new solder coating.	Flux: Ethanol solution of rosin 25(wt)% (Immersed for 5s to 10s) Solder: Sn-3.0Ag-0.5Cu Pre-Heating: $150^{\circ}\text{C} \pm 10^{\circ}\text{C}$ / 60s to 90s Solder Temperature: $240^{\circ}\text{C} \pm 5^{\circ}\text{C}$ Immersion Time: $3\text{s} \pm 1\text{s}$
7.5	Resistance to Soldering Heat	Appearance: No damage Inductance Change: within $\pm 10\%$	Flux: Ethanol solution of rosin 25(wt)% (Immersed for 5s to 10s) Solder: Sn-3.0Ag-0.5Cu Pre-Heating: $150^{\circ}\text{C} \pm 10^{\circ}\text{C}$ / 1 min to 2 min Solder Temperature: $270^{\circ}\text{C} \pm 5^{\circ}\text{C}$ Immersion Time: $10\text{s} \pm 1\text{s}$ Then measured after exposure in the room condition for $24\text{h} \pm 2\text{h}$ .

## 8. Environmental Performance

It shall be soldered on the substrate.

No.	Item	Specification	Test Method
8.1	Humidity	Appearance: No damage Inductance Change: within $\pm 10\%$	Temperature: $40^{\circ}\text{C} \pm 2^{\circ}\text{C}$ Humidity: 90%(RH) to 95%(RH) Time: 1000h (+48h, -0h) Then measured after exposure in the room condition for $24\text{h} \pm 2\text{h}$ .
8.2	Heat Life		Temperature: $125^{\circ}\text{C} \pm 2^{\circ}\text{C}$ Current: Rated Current (See the 3.) Time: 1000h (+48h, -0h) Then measured after exposure in the room condition for $24\text{h} \pm 2\text{h}$ .
8.3	Humidity Load		Temperature: $40^{\circ}\text{C} \pm 2^{\circ}\text{C}$ Humidity: 90%(RH) to 95%(RH) Current: Rated Current (See the 3.) Time: 1000h (+48h, -0h) Then measured after exposure in the room condition for $24\text{h} \pm 2\text{h}$ .
8.4	Temperature Cycle		1 cycle: 1 step: $-55^{\circ}\text{C}$ ( $+0^{\circ}\text{C}$ , $-3^{\circ}\text{C}$ ) / $30\text{ min} \pm 3\text{ min}$ 2 step: Ordinary temp. / 2 min to 3 min 3 step: $+125^{\circ}\text{C}$ ( $+3^{\circ}\text{C}$ , $-0^{\circ}\text{C}$ ) / $30\text{ min} \pm 3\text{ min}$ 4 step: Ordinary temp. / 2 min to 3 min Total of 10 cycles Then measured after exposure in the room condition for $24\text{h} \pm 2\text{h}$ .

## 9. Specification of Packaging

### 9.1 Appearance and Dimensions of paper tape (8mm-wide)

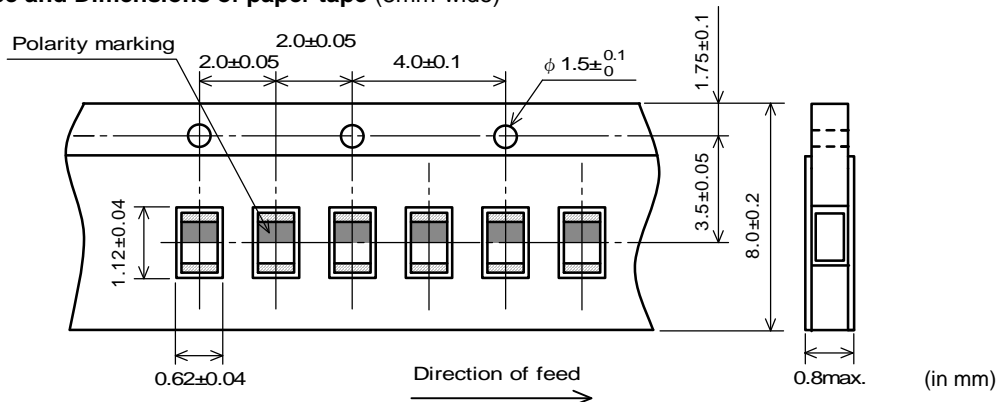

### 9.2 Specification of Taping

- (1) Packing quantity (standard quantity)  
10,000 pcs. / reel
- (2) Packing Method  
Products shall be packed in the cavity of the base tape and sealed by top tape and bottom tape.
- (3) Sprocket hole  
The sprocket holes are to the right as the tape is pulled toward the user.
- (4) Spliced point  
Base tape and Top tape has no spliced point.
- (5) Missing components number  
Missing components number within 0.1 % of the number per reel or 1 pc., whichever is greater, and are not continuous. The Specified quantity per reel is kept.

### 9.3 Pull Strength

Top tape	5N min.
Bottom tape	

### 9.4 Peeling off force of cover tape

Speed of Peeling off	300mm / min
Peeling off force	0.1N to 0.6N (minimum value is typical)

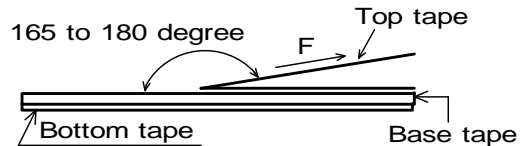

### 9.5 Dimensions of Leader-tape, Trailer and Reel

There shall be leader-tape ( top tape and empty tape) and trailer-tape (empty tape) as follows.

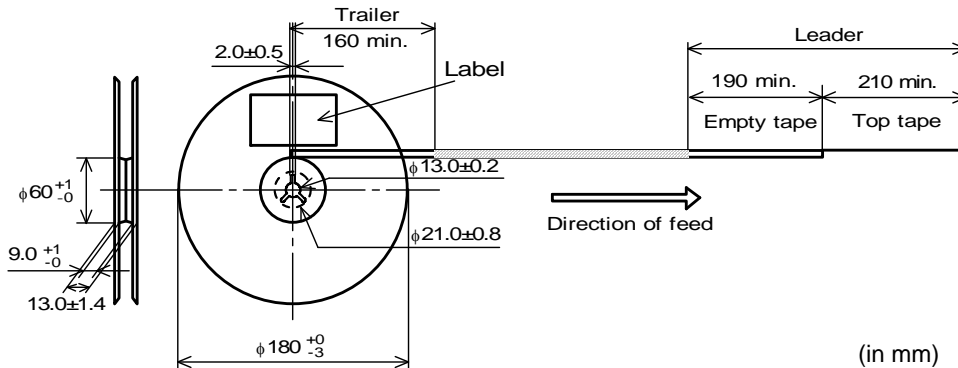

### 9.6 Marking for reel

Customer part number, MURATA part number, Inspection number (\*1), RoHS marking (\*2), Quantity etc ...

\*1) <Expression of Inspection No.>

□□ 0000 XXX  
(1) (2) (3)

- (1) Factory Code
- (2) Date      First digit : Year / Last digit of year  
                  Second digit : Month / Jan. to Sep. → 1 to 9, Oct. to Dec. → O, N, D  
                  Third, Fourth digit : Day
- (3) Serial No.

\*2) <Expression of RoHS marking >

ROHS - Y (Δ)  
(1) (2)

- (1) RoHS regulation conformity parts.
- (2) MURATA classification number

### 9.7 Marking for Outside package (corrugated paper box)

Customer name, Purchasing order number, Customer part number, MURATA part number, RoHS marking (\*2), Quantity, etc ...

### 9.8. Specification of Outer Case

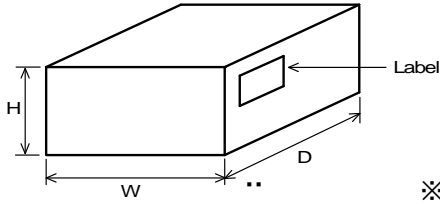

Outer Case Dimensions (mm)			Standard Reel Quantity in Outer Case (Reel)
W	D	H	
186	186	93	5

※ Above Outer Case size is typical. It depends on a quantity of an order.

### 10. ⚠ Caution

#### Limitation of Applications

Please contact us before using our products for the applications listed below which require especially high reliability for the prevention of defects which might directly cause damage to the third party's life, body or property.

- |                                   |  |
|-----------------------------------|--|
| (1) Aircraft equipment            | (6) Transportation equipment (vehicles, trains, ships, etc.)   |
| (2) Aerospace equipment           | (7) Traffic signal equipment   |
| (3) Undersea equipment            | (8) Disaster prevention / crime prevention equipment   |
| (4) Power plant control equipment | (9) Data-processing equipment  |
| (5) Medical equipment             | (10) Applications of similar complexity and /or reliability requirements to the applications listed in the above |

### 11. Notice

Products can only be soldered with reflow.  
 This product is designed for solder mounting.  
 Please consult us in advance for applying other mounting method such as conductive adhesive.

#### 11.1 Land pattern designing

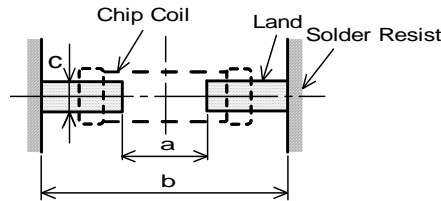

a	0.4
b	1.4 to 1.5
c	0.5 to 0.6

(in mm)

#### 11.2 Flux, Solder

- Use rosin-based flux.  
 Don't use highly acidic flux with halide content exceeding 0.2(wt)% (chlorine conversion value).  
 Don't use water-soluble flux.
- Use Sn-3.0Ag-0.5Cu solder.
- Standard thickness of solder paste : 100 μm to 150 μm.

### 11.3 Reflow soldering conditions

- Inductance value may be changed a little due to the amount of solder.  
So, the chip coil shall be soldered by reflow so that the solder volume can be controlled.
- Pre-heating should be in such a way that the temperature difference between solder and product surface is limited to 150°C max. Cooling into solvent after soldering also should be in such a way that the temperature difference is limited to 100°C max.  
Insufficient pre-heating may cause cracks on the product, resulting in the deterioration of products quality.
- Standard soldering profile and the limit soldering profile is as follows.  
The excessive limit soldering conditions may cause leaching of the electrode and/or resulting in the deterioration of product quality.

#### • Reflow soldering profile

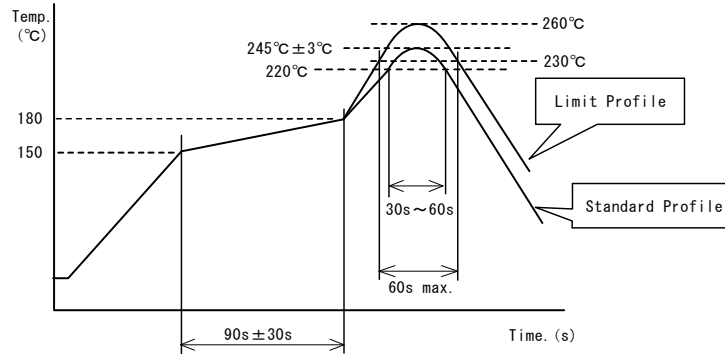

	Standard Profile	Limit Profile
Pre-heating	150°C~180°C, 90s±30s	
Heating	above 220°C, 30s~60s	above 230°C, 60s max.
Peak temperature	245°C±3°C	260°C, 10s
Cycle of reflow	2 times	2 times

### 11.4 Reworking with soldering iron

The following conditions must be strictly followed when using a soldering iron.

Pre-heating	150°C, 1 min
Tip temperature	350°C max.
Soldering iron output	80W max.
Tip diameter	φ 3mm max.
Soldering time	3(+1, -0)s
Time	2 times

Note : Do not directly touch the products with the tip of the soldering iron in order to prevent the crack on the products due to the thermal shock.

### 11.5 Solder Volume

- Solder shall be used not to be exceed the upper limits as shown below.
- Accordingly increasing the solder volume, the mechanical stress to Chip is also increased.  
Exceeding solder volume may cause the failure of mechanical or electrical performance.

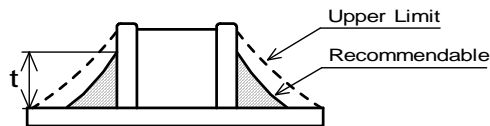

$$1/3T \leq t \leq T$$

T : thickness of product



**11.6 Product's location**

The following shall be considered when designing and laying out P.C.B.'s.

- (1) P.C.B. shall be designed so that products are not subject to the mechanical stress due to warping the board.

[Products direction]

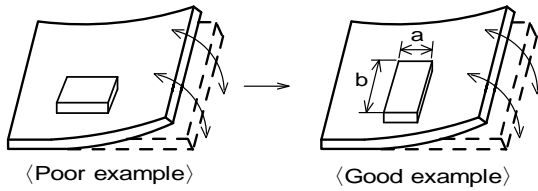

Products shall be located in the sideways direction (Length: $a < b$ ) to the mechanical stress.

- (2) Products location on P.C.B. separation

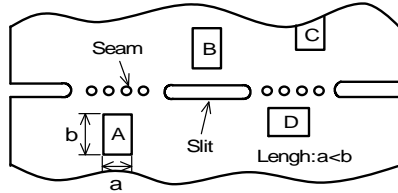

Products (A, B, C, D) shall be located carefully so that products are not subject to the mechanical stress due to warping the board. Because they may be subjected the mechanical stress in order of  $A > C > B \cong D$ .

**11.7 Cleaning Conditions**

Products shall be cleaned on the following conditions.

- (1) Cleaning temperature shall be limited to 60°C max. (40°C max for IPA.)
- (2) Ultrasonic cleaning shall comply with the following conditions with avoiding the resonance phenomenon at the mounted products and P.C.B.
  - Power : 20 W / l max.      Frequency : 28kHz to 40kHz      Time : 5 min max.
- (3) Cleaner
  - 1. Alcohol type cleaner  
Isopropyl alcohol (IPA)
  - 2. Aqueous agent  
PINE ALPHA ST-100S
- (4) There shall be no residual flux and residual cleaner after cleaning. In the case of using aqueous agent, products shall be dried completely after rinse with de-ionized water in order to remove the cleaner.
- (5) Other cleaning    Please contact us.

**11.8 Resin coating**

The inductance value may change and/or it may affect on the product's performance due to high cure-stress of resin to be used for coating/molding products. So please pay your careful attention when you select resin. In prior to use, please make the reliability evaluation with the product mounted in your application set.

**11.9 Handling of a substrate**

After mounting products on a substrate, do not apply any stress to the product caused by bending or twisting to the substrate when cropping the substrate, inserting and removing a connector from the substrate or tightening screw to the substrate. Excessive mechanical stress may cause cracking in the product.

Bending

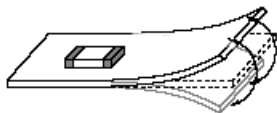

Twisting

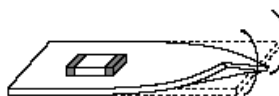

**11.10 Storage and Handling Requirements**

## (1) Storage period

Use the products within 6 months after delivered.  
Solderability should be checked if this period is exceeded.

## (2) Storage conditions

• Products should be stored in the warehouse on the following conditions.

Temperature : -10°C to 40°C

Humidity : 15% to 85% relative humidity No rapid change on temperature and humidity

Don't keep products in corrosive gases such as sulfur, chlorine gas or acid, or it may cause oxidization of electrode, resulting in poor solderability.

• Products should be stored on the palette for the prevention of the influence from humidity, dust and so on.

• Products should be stored in the warehouse without heat shock, vibration, direct sunlight and so on.

• Products should be stored under the airtight packaged condition.

## (3) Handling Condition

Care should be taken when transporting or handling product to avoid excessive vibration or mechanical shock.

**12. ⚠ Note**

(1) Please make sure that your product has been evaluated in view of your specifications with our product being mounted to your product.

(2) You are requested not to use our product deviating from the reference specifications.

(3) The contents of this reference specification are subject to change without advance notice.

Please approve our product specifications or transact the approval sheet for product specifications before ordering.

**<Electrical Performance:Measuring Method of Inductance/Q>**

(1) Residual elements and stray elements of test fixture can be described by F-parameter shown in following.

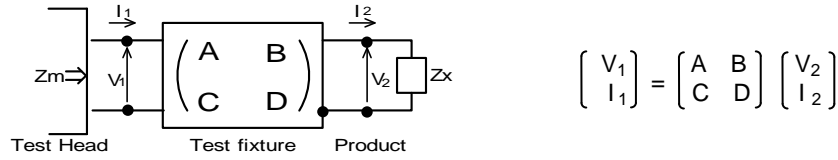

(2) The impedance of chip coil Zx and measured value Zm can be described by input/output current/voltage.

$$Z_m = \frac{V_1}{I_1} \quad , \quad Z_x = \frac{V_2}{I_2}$$

(3) Thus, the relation between Zx and Zm is following;

$$Z_x = \alpha \frac{Z_m - \beta}{1 - Z_m \Gamma} \quad \text{where, } \alpha = D / A = 1$$

$$\beta = B / D = Z_{sm} - (1 - Y_{om}) Z_{ss}$$

$$\Gamma = C / A = Y_{om}$$

$Z_{sm}$ :measured impedance of short chip  
 $Z_{ss}$ :residual impedance of short chip (0nH)  
 $Y_{om}$ :measured admittance when opening the fixture

(4) Lx and Qx shall be calculated with the following equation.

$$L_x = \frac{\text{Im}(Z_x)}{2 \pi f} \quad , \quad Q_x = \frac{\text{Im}(Z_x)}{\text{Re}(Z_x)}$$

$L_x$  :Inductance of chip coil  
 $Q_x$ :Q of chip coil  
 $f$  :Measuring frequency