

MITSUBISHI IGBT MODULES
CM100DUS-12F
 HIGH POWER SWITCHING USE
 INSULATED TYPE

CM100DUS-12F



Dual (Half-Bridge)

- 4th generation Fast switching IGBT module -

Collector current I_C **100 A**
 Collector-emitter voltage V_{CES} **600 V**
 Maximum junction temperature T_{jmax} ... **150 °C**

- Flat base Type
- Copper base plate
- RoHS Directive compliant
- UL Recognized under UL1557, File E323585

APPLICATION

High frequency (30 kHz ~ 60 kHz) switching use: Induction heating, Power supply, etc.

OUTLINE DRAWING & INTERNAL CONNECTION

Dimension in mm

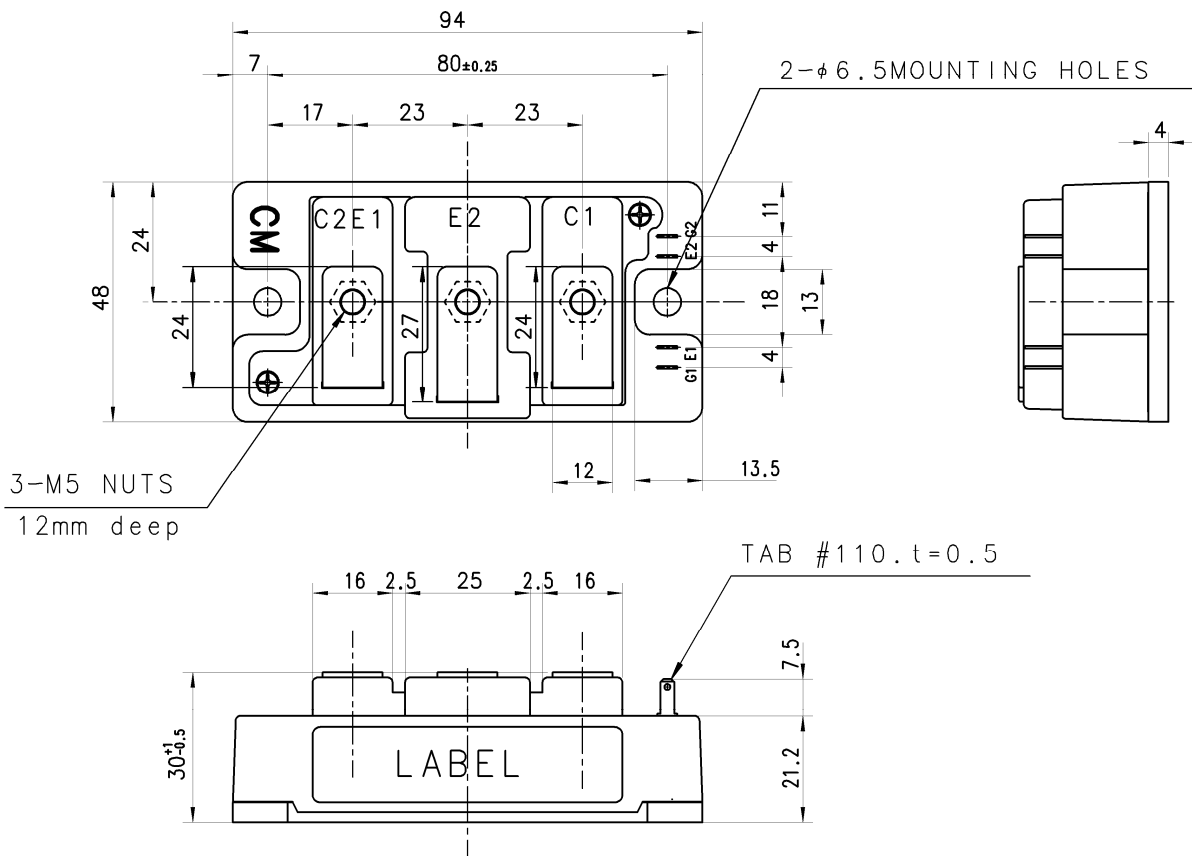

3-M5 NUTS
 12mm deep

TAB #110. t=0.5

Tolerance otherwise specified

Division of Dimension	Tolerance
0.5 to 3	±0.2
over 3 to 6	±0.3
over 6 to 30	±0.5
over 30 to 120	±0.8
over 120 to 400	±1.2

INTERNAL CONNECTION

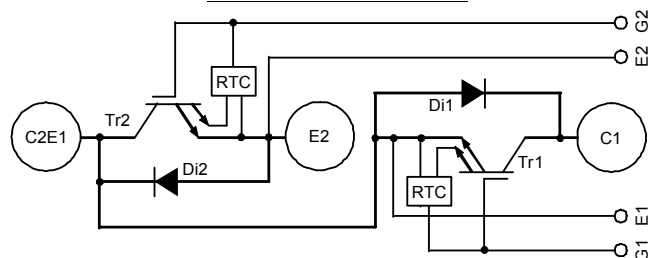

MITSUBISHI IGBT MODULES
CM100DUS-12F
HIGH POWER SWITCHING USE
INSULATED TYPE

ABSOLUTE MAXIMUM RATINGS ($T_j=25\text{ }^\circ\text{C}$, unless otherwise specified)

Symbol	Item	Conditions	Rating	Unit
V_{CES}	Collector-emitter voltage	G-E short-circuited	600	V
V_{GES}	Gate-emitter voltage	C-E short-circuited	± 20	V
I_C	Collector current	$T_C=25\text{ }^\circ\text{C}$ (Note.2)	100	A
I_{CRM}		Pulse, Repetitive (Note.4)	200	
P_{tot}	Total power dissipation	$T_C=25\text{ }^\circ\text{C}$ (Note.2, 5)	350	W
P_{tot}'		$T_C'=25\text{ }^\circ\text{C}$ (Note.3, 5)	445	
I_E (Note.1)	Emitter current (Free wheeling diode forward current)	$T_C=25\text{ }^\circ\text{C}$ (Note.2)	100	A
I_{ERM} (Note.1)		Pulse, Repetitive (Note.4)	200	
T_j	Junction temperature	-	-40 ~ +150	$^\circ\text{C}$
T_{stg}	Storage temperature	-	-40 ~ +125	
V_{isol}	Isolation voltage	Terminals to base plate, RMS, f=60 Hz, AC 1 min	2500	V

ELECTRICAL CHARACTERISTICS ($T_j=25\text{ }^\circ\text{C}$, unless otherwise specified)

Symbol	Item	Conditions	Limits			Unit	
			Min.	Typ.	Max.		
I_{CES}	Collector-emitter cut-off current	$V_{CE}=V_{CES}$, G-E short-circuited	-	-	1	mA	
I_{GES}	Gate-emitter leakage current	$\pm V_{GE}=V_{GES}$, C-E short-circuited	-	-	20	μA	
$V_{GE(th)}$	Gate-emitter threshold voltage	$I_C=10\text{ mA}$, $V_{CE}=10\text{ V}$	5	6	7	V	
V_{CESat}	Collector-emitter saturation voltage	$I_C=100\text{ A}$ (Note.6), $V_{GE}=15\text{ V}$	$T_j=25\text{ }^\circ\text{C}$	1.7	2.0	2.7	V
			$T_j=125\text{ }^\circ\text{C}$	-	1.95	-	
C_{ies}	Input capacitance	$V_{CE}=10\text{ V}$, G-E short-circuited	-	-	27	nF	
C_{oes}	Output capacitance		-	-	1.8		
C_{res}	Reverse transfer capacitance		-	-	1.0		
Q_G	Gate charge	$V_{CC}=300\text{ V}$, $I_C=100\text{ A}$, $V_{GE}=15\text{ V}$	-	620	-	nC	
$t_{d(on)}$	Turn-on delay time	$V_{CC}=300\text{ V}$, $I_C=100\text{ A}$, $V_{GE}=\pm 15\text{ V}$, $R_G=6.3\text{ }\Omega$, Inductive load	-	-	100	ns	
t_r	Rise time		-	-	80		
$t_{d(off)}$	Turn-off delay time		-	-	300		
t_f	Fall time		-	-	150		
V_{EC} (Note.1)	Emitter-collector voltage	$I_E=100\text{ A}$ (Note.6), G-E short-circuited	-	2.0	2.6	V	
t_{rr} (Note.1)	Reverse recovery time	$V_{CC}=300\text{ V}$, $I_E=100\text{ A}$, $V_{GE}=\pm 15\text{ V}$, $R_G=6.3\text{ }\Omega$, Inductive load	-	-	150	ns	
Q_{rr} (Note.1)	Reverse recovery charge	$R_G=6.3\text{ }\Omega$, Inductive load	-	1.9	-	μC	
E_{on}	Turn-on switching energy per pulse	$V_{CC}=300\text{ V}$, $I_C=I_E=100\text{ A}$,	-	1.55	-	mJ	
E_{off}	Turn-off switching energy per pulse	$V_{GE}=\pm 15\text{ V}$, $R_G=6.3\text{ }\Omega$, $T_j=125\text{ }^\circ\text{C}$,	-	2.2	-		
E_{rr} (Note.1)	Reverse recovery energy per pulse	Inductive load	-	1.2	-		
r_g	Internal gate resistance	Per switch	-	0	-	Ω	

THERMAL RESISTANCE CHARACTERISTICS

Symbol	Item	Conditions	Limits			Unit
			Min.	Typ.	Max.	
$R_{th(j-c)Q}$	Thermal resistance (Note.2)	Junction to case, per IGBT	-	-	0.35	K/W
$R_{th(j-c)D}$		Junction to case, per FWDi	-	-	0.70	
$R_{th(c-s)}$	Contact thermal resistance (Note.2)	Case to heat sink, per 1/2 module, Thermal grease applied (Note.7)	-	0.07	-	K/W
$R_{th(j-c')Q}$	Thermal resistance (Note.3)	Junction to case, per IGBT	-	-	0.28	K/W
$R_{th(j-c')D}$		Junction to case, per FWDi	-	-	0.40	

MECHANICAL CHARACTERISTICS

Symbol	Item	Conditions	Limits			Unit
			Min.	Typ.	Max.	
M_t	Mounting torque	Main terminals M 5 screw	2.5	3.0	3.5	N·m
M_s		Mounting to heat sink M 6 screw	3.5	4.0	4.5	
m	Weight	-	-	310	-	g
e_c	Flatness of base plate	On the centerline X, Y (Note.8)	-100	-	+100	μm

MITSUBISHI IGBT MODULES
CM100DUS-12F
HIGH POWER SWITCHING USE
INSULATED TYPE

RECOMMENDED OPERATING CONDITIONS ($T_a=25\text{ }^\circ\text{C}$)

Symbol	Item	Conditions	Limits			Unit
			Min.	Typ.	Max.	
V_{CC}	(DC) Supply voltage	Applied across C1-E2	-	300	400	V
V_{GEon}	Gate (-emitter drive) voltage	Applied across G1-Es1/G2-Es2	13.5	15.0	16.5	
R_G	External gate resistance	Per switch	6.3	-	63	Ω

Note.1: Represent ratings and characteristics of the anti-parallel, emitter-collector free wheeling diode (FWDi).

Note.2: Case temperature (T_c) measured point is base plate side. (Refer to the figure of chip location)

Note.3: Case temperature (T_c) and heat sink temperature (T_s) are defined on the each surface of base plate and heat sink just under the chips. (Refer to the figure of chip location)

The heat sink thermal resistance $\{R_{th(s-a)}\}$ should measure just under the chips.

Note.4: Pulse width and repetition rate should be such that the device junction temperature (T_j) dose not exceed T_{jmax} rating.

Note.5: Junction temperature (T_j) should not increase beyond T_{jmax} rating.

Note.6: Pulse width and repetition rate should be such as to cause negligible temperature rise.

(Refer to the figure of test circuit)

Note.7: Typical value is measured by using thermally conductive grease of $\lambda=0.9\text{ W/(m}\cdot\text{K)}$.

Note.8: Base plate flatness measurement points are as in the following figure.

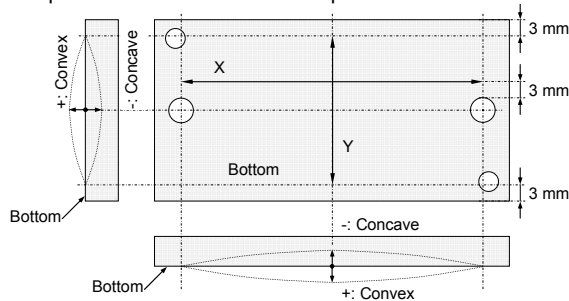

CHIP LOCATION (Top view)

Dimension in mm, tolerance: $\pm 1\text{ mm}$

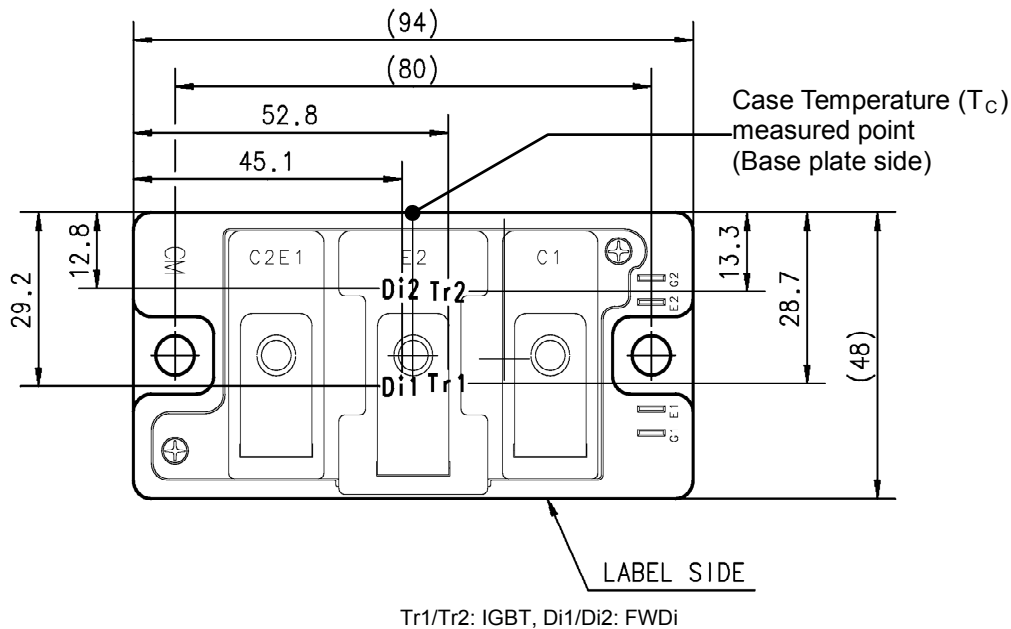

TEST CIRCUIT AND WAVEFORMS

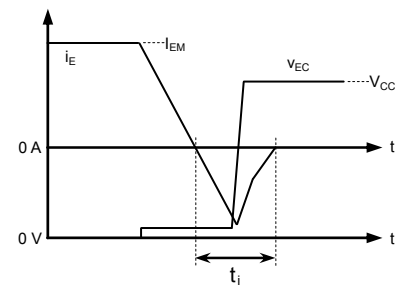
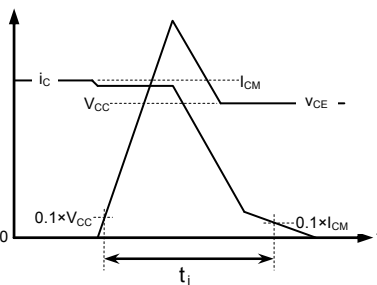
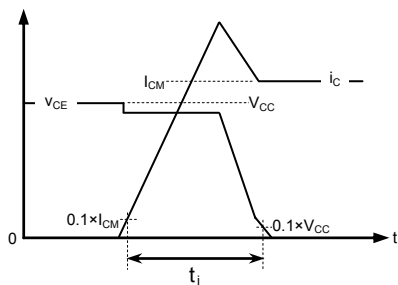
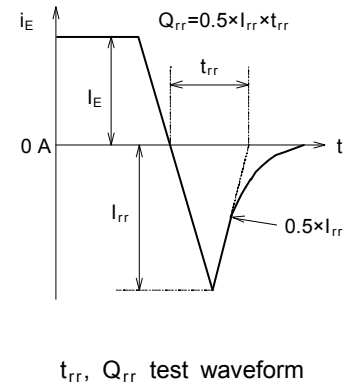
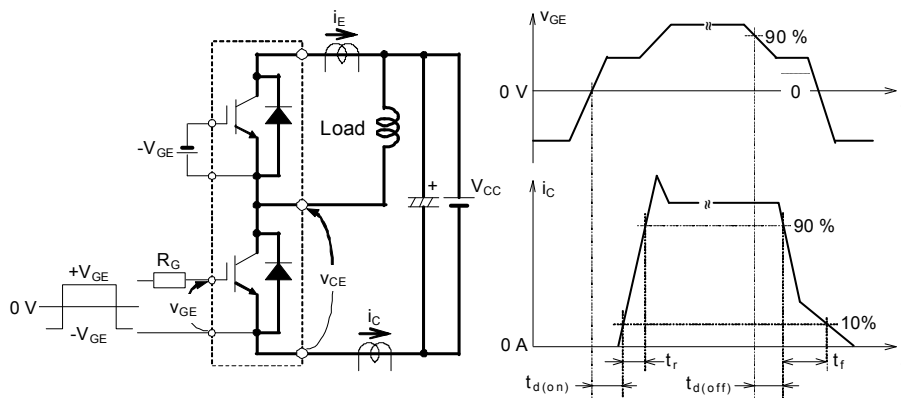
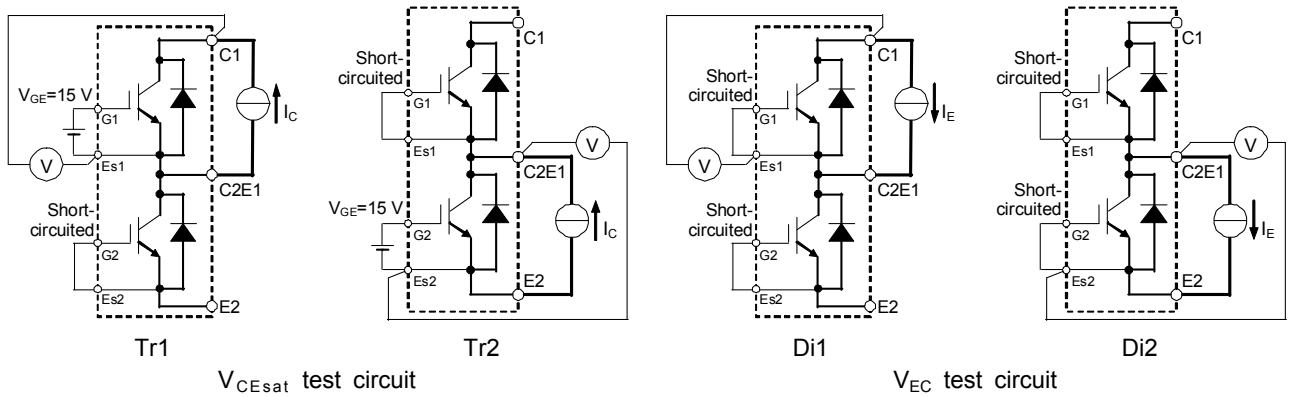

Turn-on / Turn-off switching energy and Reverse recovery energy test waveforms (Integral time instruction drawing)

PERFORMANCE CURVES

INVERTER PART

OUTPUT CHARACTERISTICS
 (TYPICAL)

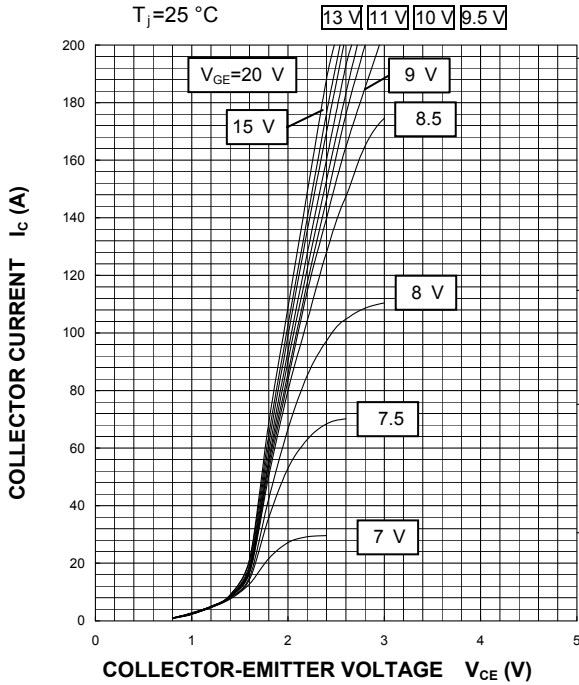

COLLECTOR-EMITTER SATURATION
 VOLTAGE CHARACTERISTICS
 (TYPICAL)

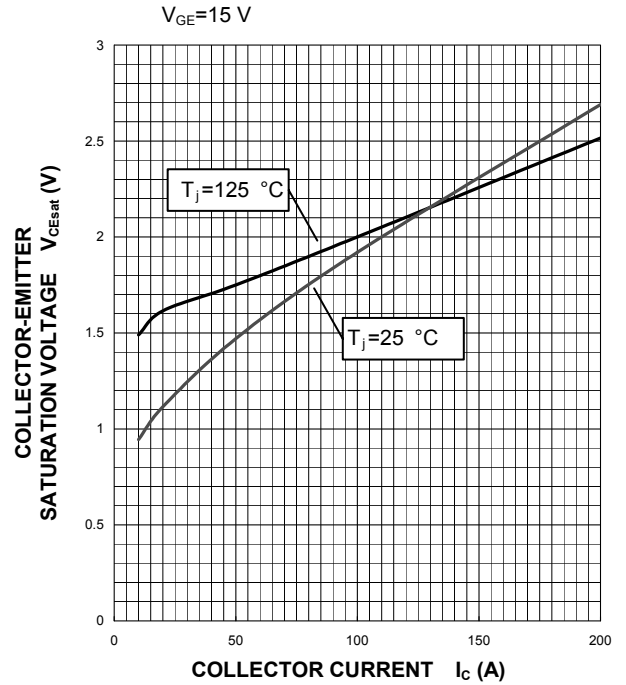

COLLECTOR-EMITTER SATURATION
 VOLTAGE CHARACTERISTICS
 (TYPICAL)

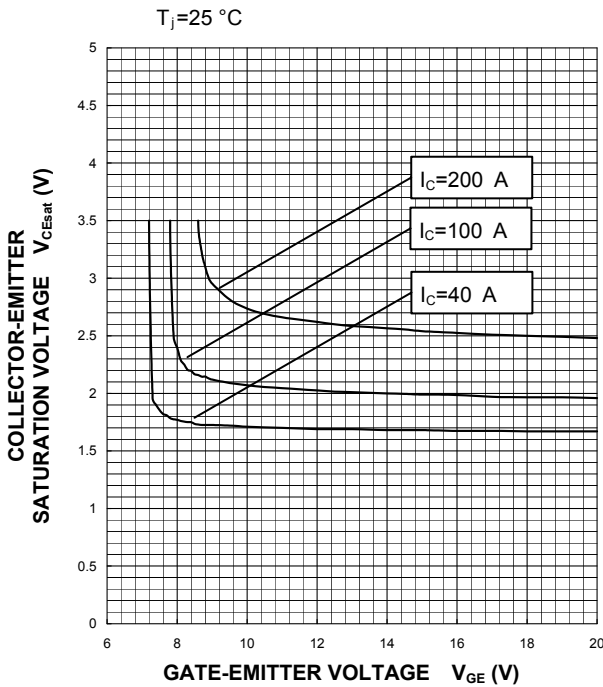

FREE WHEELING DIODE
 FORWARD CHARACTERISTICS
 (TYPICAL)

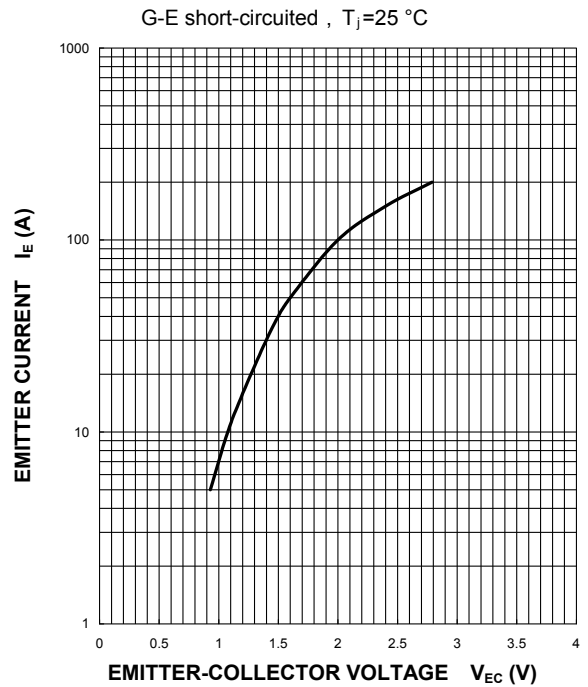

MITSUBISHI IGBT MODULES
CM100DUS-12F
 HIGH POWER SWITCHING USE
 INSULATED TYPE

**HALF-BRIDGE
 SWITCHING CHARACTERISTICS
 (TYPICAL)**

$V_{CC}=300\text{ V}$, $V_{GE}=\pm 15\text{ V}$, $R_G=6.3\ \Omega$,
 $T_j=125\text{ }^\circ\text{C}$, INDUCTIVE LOAD

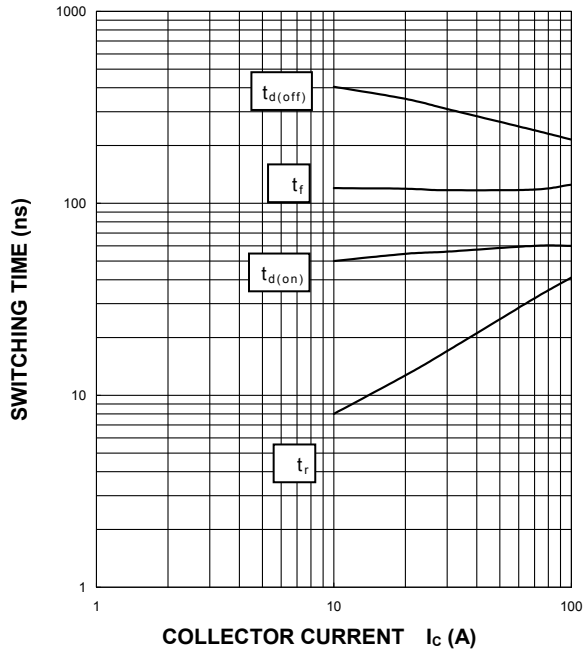

**FREE WHEELING DIODE
 REVERSE RECOVERY CHARACTERISTICS
 (TYPICAL)**

$V_{CC}=300\text{ V}$, $V_{GE}=\pm 15\text{ V}$, $R_G=6.3\ \Omega$,
 $T_j=125\text{ }^\circ\text{C}$, INDUCTIVE LOAD

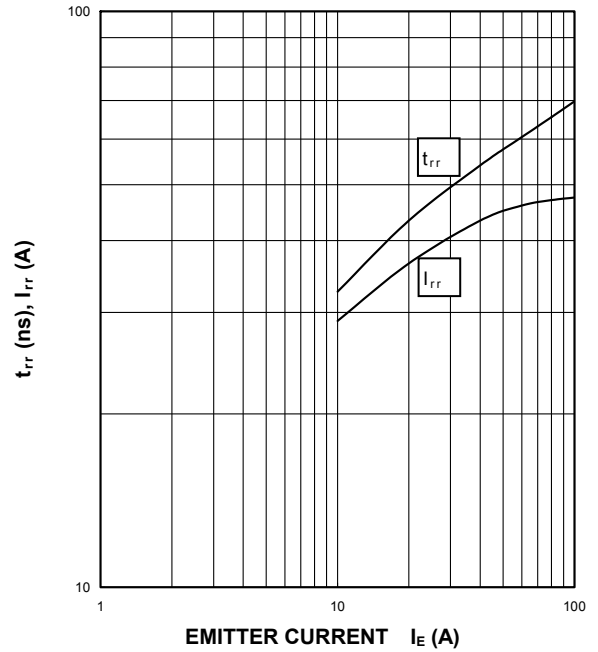

**HALF-BRIDGE
 SWITCHING CHARACTERISTICS
 (TYPICAL)**

$V_{CC}=300\text{ V}$, $V_{GE}=\pm 15\text{ V}$, $R_G=6.3\ \Omega$, $T_j=125\text{ }^\circ\text{C}$,
 INDUCTIVE LOAD, PER PULSE

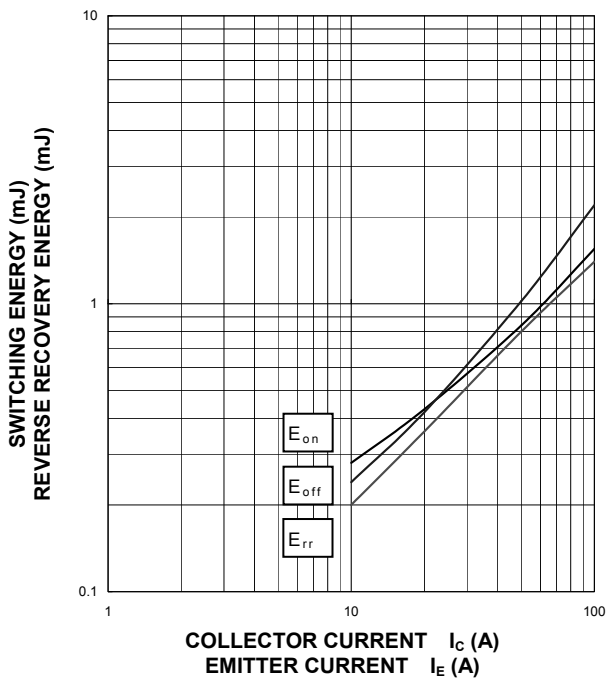

**HALF-BRIDGE
 SWITCHING CHARACTERISTICS
 (TYPICAL)**

$V_{CC}=300\text{ V}$, $I_c/I_E=100\text{ A}$, $V_{GE}=\pm 15\text{ V}$, $T_j=125\text{ }^\circ\text{C}$,
 INDUCTIVE LOAD, PER PULSE

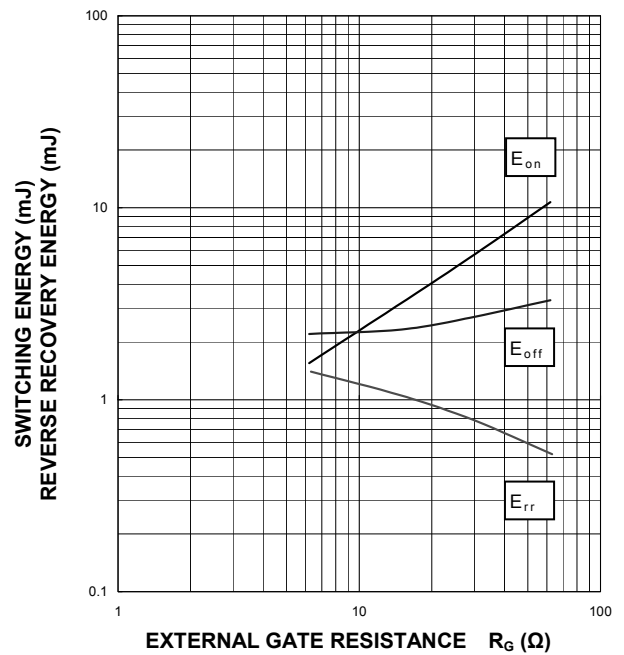

**CAPACITANCE CHARACTERISTICS
 (TYPICAL)**

G-E short-circuited, $T_j=25\text{ }^\circ\text{C}$

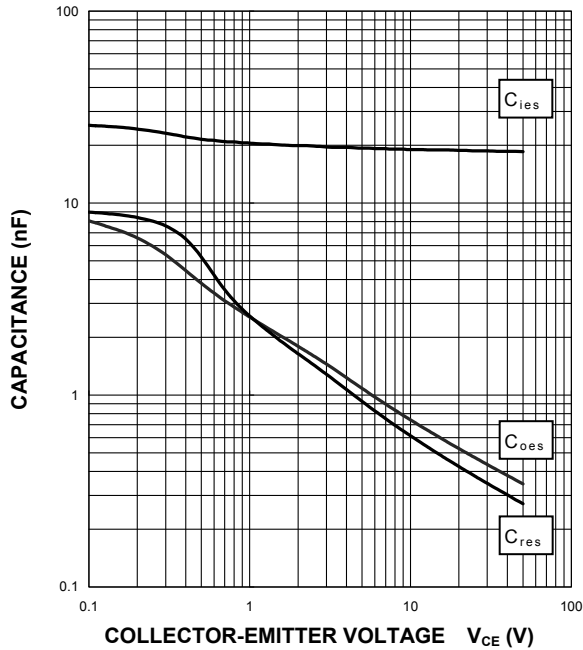

**GATE CHARGE CHARACTERISTICS
 (TYPICAL)**

$I_C=100\text{ A}$, $T_j=25\text{ }^\circ\text{C}$

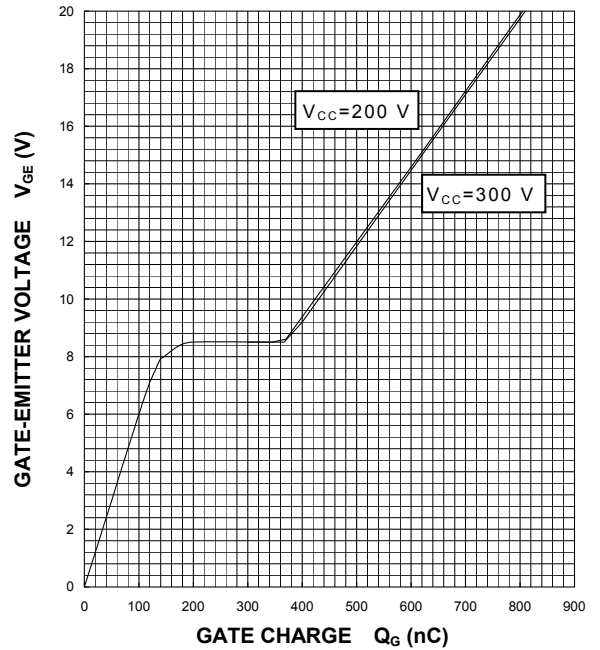

**TRANSIENT THERMAL IMPEDANCE
 CHARACTERISTICS
 (MAXIMUM)**

Single pulse, $T_c'=25\text{ }^\circ\text{C}$

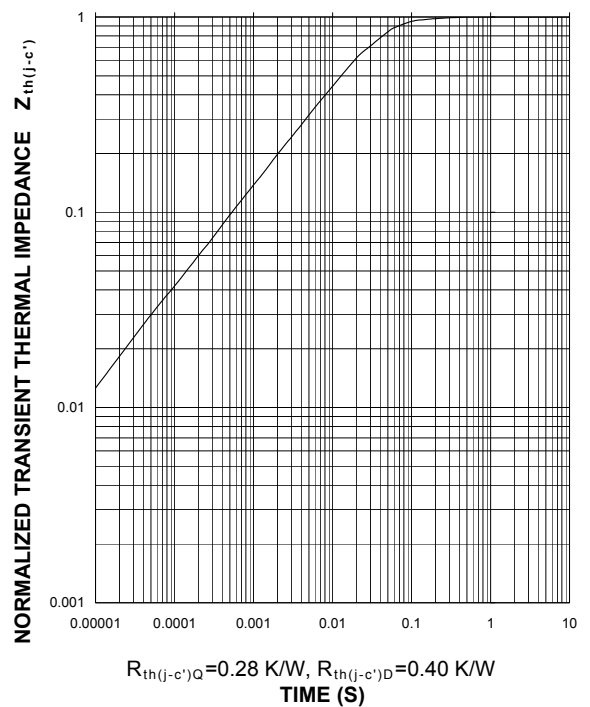

Keep safety first in your circuit designs!

·Mitsubishi Electric Corporation puts the maximum effort into making semiconductor products better and more reliable, but there is always the possibility that trouble may occur with them. Trouble with semiconductors may lead to personal injury, fire or property damage.

Remember to give due consideration to safety when making your circuit designs, with appropriate measures such as (i) placement of substitutive, auxiliary circuits, (ii) use of non-flammable material or (iii) prevention against any malfunction or mishap.

Notes regarding these materials

·These materials are intended as a reference to assist our customers in the selection of the Mitsubishi semiconductor product best suited to the customer's application; they do not convey any license under any intellectual property rights, or any other rights, belonging to Mitsubishi Electric Corporation or a third party.

·Mitsubishi Electric Corporation assumes no responsibility for any damage, or infringement of any third-party's rights, originating in the use of any product data, diagrams, charts, programs, algorithms, or circuit application examples contained in these materials.

·All information contained in these materials, including product data, diagrams, charts, programs and algorithms represents information on products at the time of publication of these materials, and are subject to change by Mitsubishi Electric Corporation without notice due to product improvements or other reasons. It is therefore recommended that customers contact Mitsubishi Electric Corporation or an authorized Mitsubishi Semiconductor product distributor for the latest product information before purchasing a product listed herein.

The information described here may contain technical inaccuracies or typographical errors. Mitsubishi Electric Corporation assumes no responsibility for any damage, liability, or other loss arising from these inaccuracies or errors.

Please also pay attention to information published by Mitsubishi Electric Corporation by various means, including the Mitsubishi Semiconductor home page (<http://www.mitsubishichips.com/Global/index.html>).

·When using any or all of the information contained in these materials, including product data, diagrams, charts, programs, and algorithms, please be sure to evaluate all information as a total system before making a final decision on the applicability of the information and products. Mitsubishi Electric Corporation assumes no responsibility for any damage, liability or other loss resulting from the information contained herein.

·Mitsubishi Electric Corporation semiconductors are not designed or manufactured for use in a device or system that is used under circumstances in which human life is potentially at stake. Please contact Mitsubishi Electric Corporation or an authorized Mitsubishi Semiconductor product distributor when considering the use of a product contained herein for any specific purposes, such as apparatus or systems for transportation, vehicular, medical, aerospace, nuclear, or undersea repeater use.

·The prior written approval of Mitsubishi Electric Corporation is necessary to reprint or reproduce in whole or in part these materials.

·If these products or technologies are subject to the Japanese export control restrictions, they must be exported under a license from the Japanese government and cannot be imported into a country other than the approved destination.

Any diversion or reexport contrary to the export control laws and regulations of Japan and/or the country of destination is prohibited.

·Please contact Mitsubishi Electric Corporation or an authorized Mitsubishi Semiconductor product distributor for further details on these materials or the products contained therein.