



Design Example Report

Title	<i>30W Adapter using TOP245Y</i>
Specification	Input: 90 – 265 VAC Output: 9.7 V / 3.0 A
Application	Portable DVD
Author	Power Integrations Applications Department
Document Number	DER-95
Date	September 12, 2005
Revision	1.0

Summary and Features

- Low cost solution for 30 7W adapter
- EER28 core
- Small common mode choke
- Small X-cap

The products and applications illustrated herein (including circuits external to the products and transformer construction) may be covered by one or more U.S. and foreign patents or potentially by pending U.S. and foreign patent applications assigned to Power Integrations. A complete list of Power Integrations' patents may be found at www.powerint.com.

Table Of Contents

1	Introduction.....	4
2	Power Supply Specification	5
3	Schematic.....	6
4	Circuit Description	7
4.1	Input EMI Filtering	7
4.2	Reduced current limit	7
4.3	Output Rectification.....	7
4.4	Output Feedback.....	7
5	PCB Layout	8
6	Bill Of Materials	9
7	Transformer.....	10
7.1	Transformer Diagram	10
7.2	Electrical Specifications.....	10
7.3	Materials.....	10
7.4	Detailed copper shield.....	11
7.5	Transformer Construction.....	11
7.6	Winding Instructions.....	11
8	Transformer Spreadsheets.....	12
9	Performance Data	14
9.1	Efficiency.....	14
9.2	No-Load Input Power Integrations.....	14
9.3	Output regulation.....	15
9.3.1	Line regulation.....	15
9.3.2	Load regulation (taken at the end of the output cable).....	15
9.4	Thermal Performance.....	15
9.5	Maximum output current.....	16
10	Waveforms.....	16
10.1	Drain Voltage, Normal Operation	16
10.2	Output Voltage Start-up Profile	16
11	Output Ripple Measurements	17
11.1.1	Ripple Measurement Technique	17
11.1.2	Measurement Results	18
12	Loop performance.....	19
13	Conducted EMI	20
14	Revision History	21

The products and applications illustrated herein (including circuits external to the products and transformer construction) may be covered by one or more U.S. and foreign patents or potentially by pending U.S. and foreign patent applications assigned to Power Integrations. A complete list of Power Integrations' patents may be found at www.powerint.com.



Important Notes:

Although this board is designed to satisfy safety isolation requirements, the engineering prototype has not been agency approved. Therefore, all testing should be performed using an isolated source to provide power to the prototype board.

Design Reports contain a power supply design specification, schematic, bill of materials, and transformer documentation. Performance data and typical operation characteristics are included. Typically only a single prototype has been built.



1 Introduction

This document is an engineering report describing a single output 30 W power supply utilizing a TOP245Y.

The document contains the power supply specification, schematic, bill of materials, transformer documentation, printed circuit layout, and performance data.



Figure 1 – Populated Board

2 Power Supply Specification

Description	Symbol	Min	Typ	Max	Units	Comment
Input						
Voltage	V_{IN}	90		265	VAC	2 Wire – no P.E.
Frequency	f_{LINE}	47	50/60	64	Hz	
No-load Input Power (230 VAC)				1.0	W	
Outputs						
Voltage	V_{DC}		9.7		VDC	
Current	I_o		3.0		A	
Efficiency	η		81		%	Measured at P_{OUT} (30 W), 25 °C
Environmental						
Conducted EMI			Meets CISPR22B / EN55022B			
Safety			Designed to meet IEC950, UL1950 Class II			
Ambient Temperature	T_{AMB}	0		40	°C	Free convection, sea level



3 Schematic

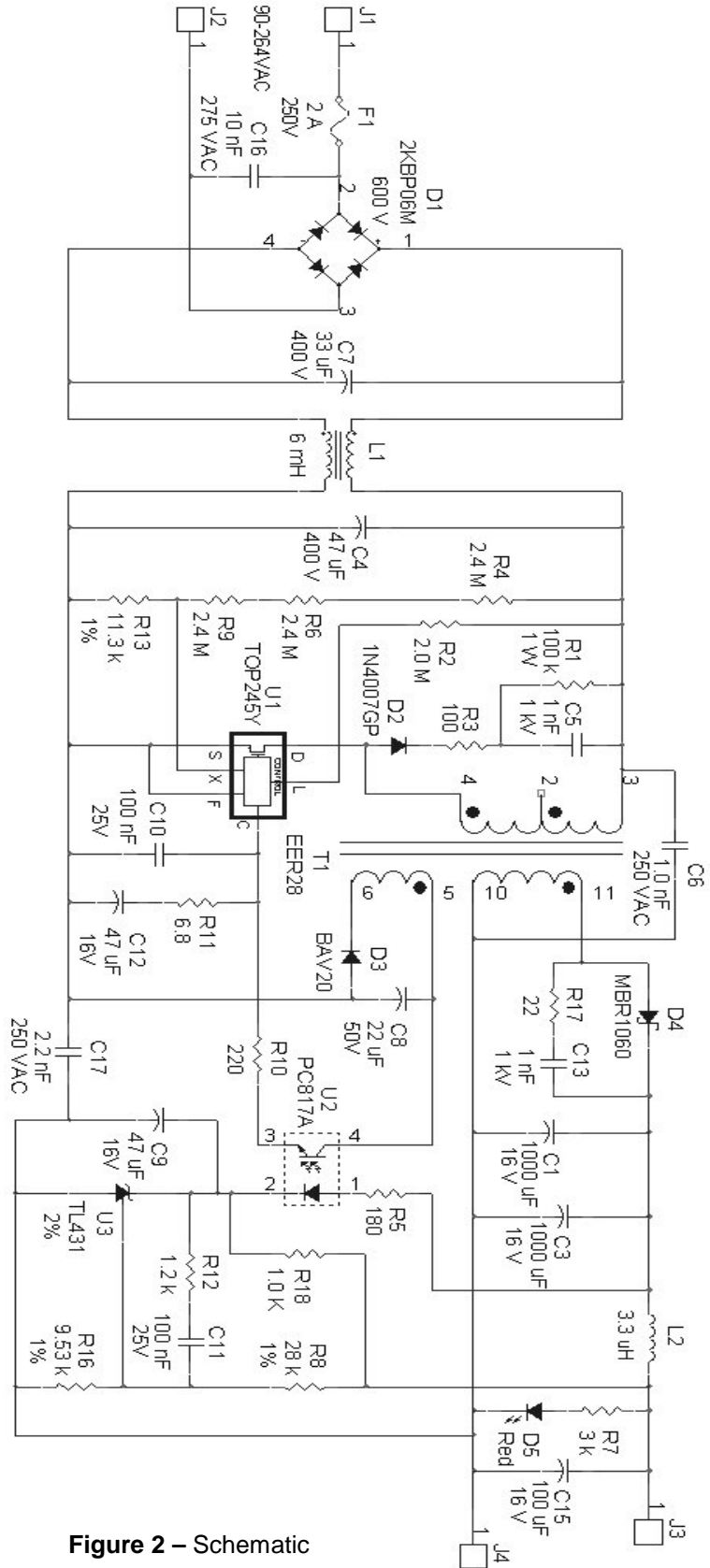

Figure 2 – Schematic

4 Circuit Description

The schematic in Figure 2 shows an off-line flyback converter using the TOP245Y. The circuit is designed for 90 VAC to 265 VAC input and provides an isolated 9.7 V, 3.0 A continuous output.

4.1 Input EMI Filtering

Conducted EMI filtering is provided by pi formed filter C7, C4, L1. The switching frequency jitter feature of the TOPSwitch-GX family allows the use of a small, low cost common mode choke for L1.

To keep the peak DRAIN voltage acceptably below the BV_{DSS} (700V) of U1, diode D2, C5, R1 and R3 form a primary clamp. This network clamps the voltage spike seen on the DRAIN due to primary leakage inductance. Diode D3 and capacitor C8 provide rectified and filtered bias supply for U1.

4.2 Reduced current limit

Resistor R4, R6, R9 and R13 are used to set the maximum current limit for both high line and low line.

R2 is used for input undervoltage lockout (UVLO).

4.3 Output Rectification

The secondary of T1 is rectified and filtered by D4, C1 & C3. Post filter choke L2 and C15 provide additional high frequency filtering.

4.4 Output Feedback

DC feedback to the output voltage regulator error amplifier (U3) comes from a voltage divider network R8 and R16. The center point of this network is tied to the 2.5 V REF pin of U3. Capacitor C11 and resistor R12 roll off the high frequency gain of U3 while R5 sets the overall gain.

C9 is a “soft finish” capacitor to eliminate output over shoot during start up.



5 PCB Layout

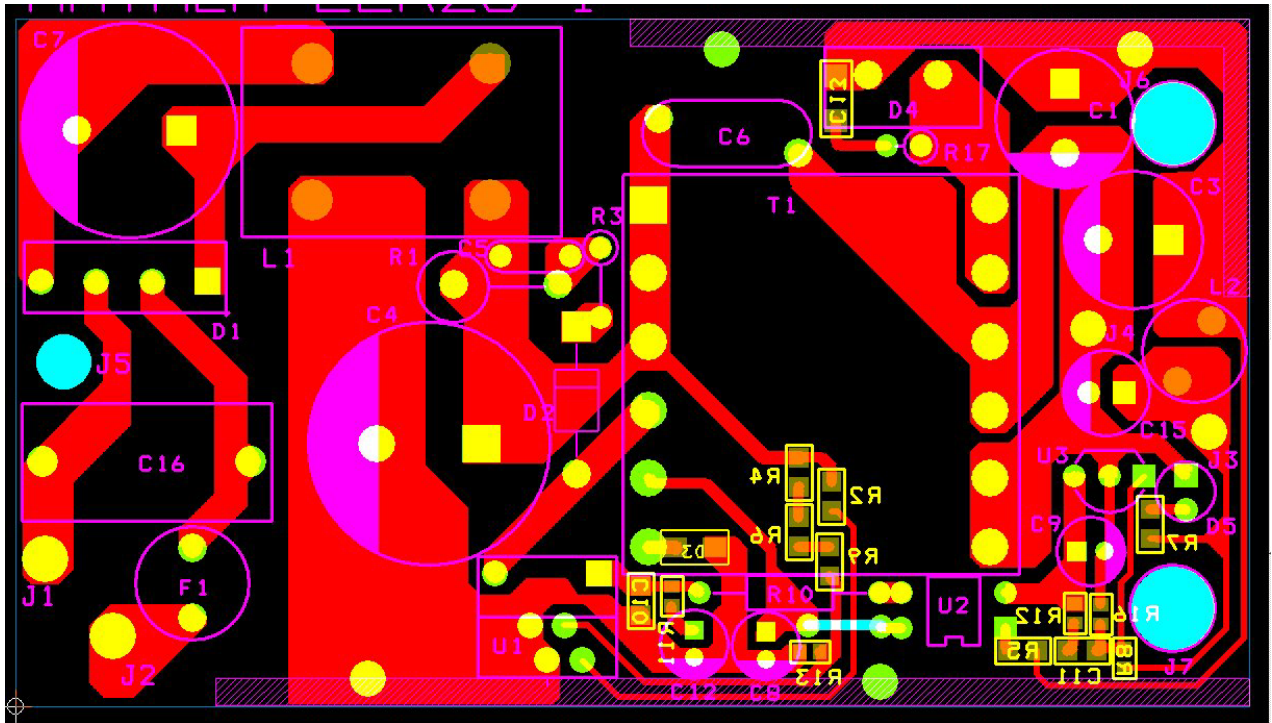

Figure 3 – Printed Circuit Layout

Note: R18 and C17 are not shown in this layout. They are added onto the bottom of the board.

6 Bill Of Materials

1	2	C1,C3	1000 uF, 16V
2	2	C9,C12	47 uF, 16V
3	2	C5,C13	1 nF
4	1	C6	1.0 nF
5	1	C7	33 uF, 400V
6	1	C4	47 uF, 400V
7	1	C8	22 uF
8	2	C10,C11	100 nF
9	1	C15	100 uF
10	1	C16	10 nF
11	1	C17	2.2 nF
12	1	D1	2KBP06M
13	1	D2	1N4007GP
14	1	D3	BAV20
15	1	D4	MBR1060
16	1	D5	Red
17	1	F1	2 A
18	1	L1	6 mH
19	1	L2	3.3 uH
20	1	R1	100 k
21	1	R2	2.0 M
22	1	R3	100
23	3	R4,R6,R9	2.4 M
24	1	R5	180
25	1	R7	3 k
26	1	R8	28 k
27	1	R10	220
28	1	R11	6.8
29	1	R12	1.2 k
30	1	R13	11.3 k
31	1	R16	9.53 k
32	1	R17	22
33	1	R18	1.0 K
34	1	T1	EER28
35	1	U1	TOP245Y
36	1	U2	PC817A
37	1	U3	TL431



7 Transformer

7.1 Transformer Diagram

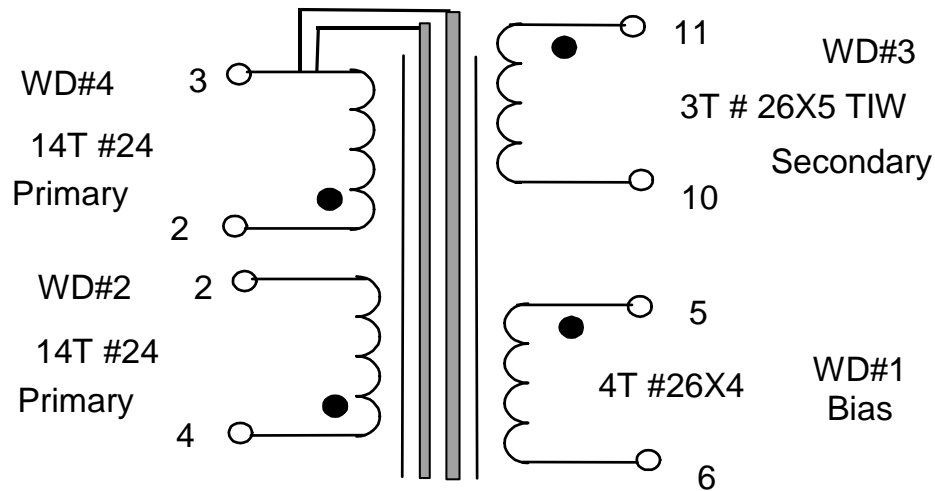

7.2 Electrical Specifications

Electrical Strength	60Hz 1minute, from Pins 1-6 to Pins 7-12	3000 V ac
Primary Inductance (Pin 4 to Pin 3)	All windings open	600 uH +/- 5% at 132 KHz
Resonant Frequency. (Pin 4 to Pin 3)	All windings open	900 KHz (Min.)
Primary Leakage Inductance. (Pin 4 to Pin 3)	Pins 10-11 shorted	4 uH Max.

7.3 Materials

Item	Description
[1]	Core: PC40EER28-Z, TDK or equivalent Gapped for AL of 765 nH/T ²
[2]	Bobbin: Horizontal 12 pin
[3]	Magnet Wire: #24 AWG
[4]	Magnet Wire: #26 AWG
[5]	Copper, 1 mil thick, 10 mm wide and 12.6 mm wide
[6]	Triple Insulated Wire: #26 AWG.
[7]	Tape: 3M 1298 Polyester Film, 2.0 mils thick, 10.6 mm wide and 16.0 mm wide
[8]	Varnish



7.4 Detailed copper shield

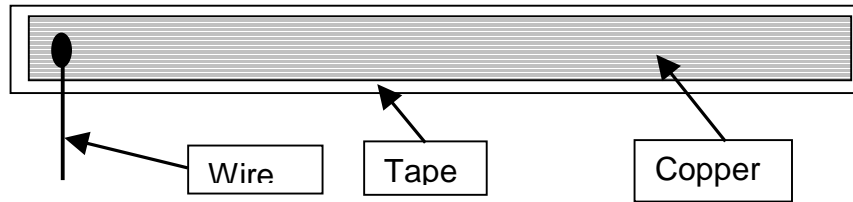

7.5 Transformer Construction

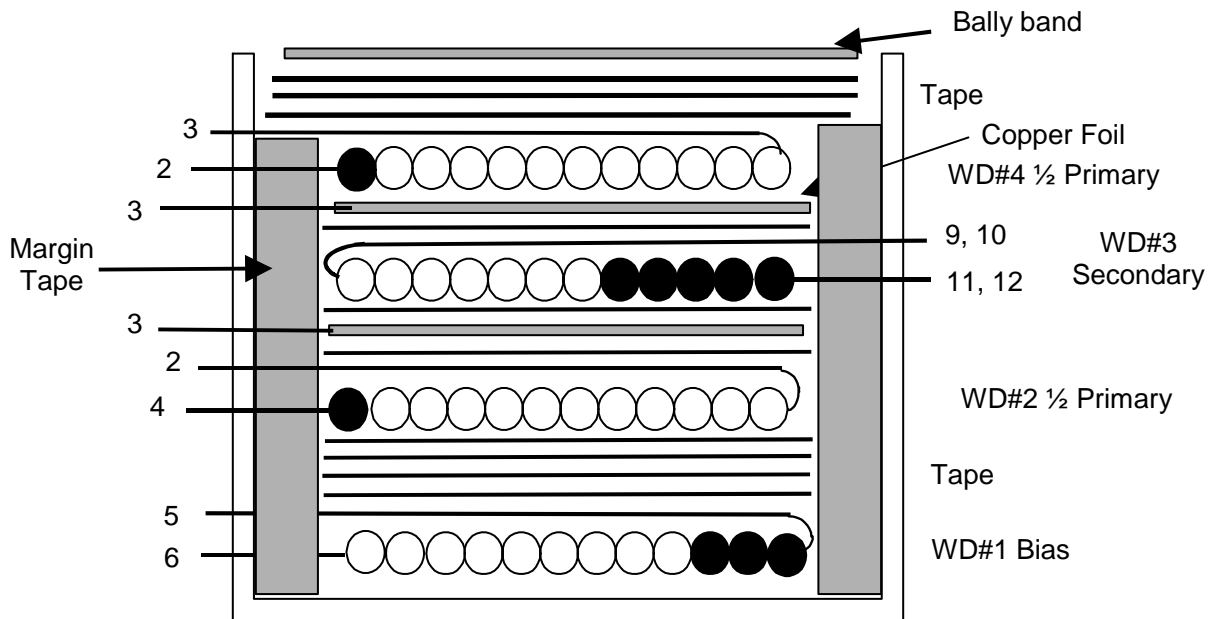

7.6 Winding Instructions

WD1 Bias Winding	Primary pin side of the bobbin oriented to left hand side. Start at Pin 11 temporarily wind 4 turns with 4 wires of item [4] parallel from right to left. Wind with tight tension. Finish on pin 6. Flip the starting lead over to pin 5.
Insulation	4 Layers of tape [7, 10.6 mm wide] for insulation.
WD#2 1/2 Primary winding	Start at pin 4, wind 14 turns of item [3] from left to right. Finish at pin 2
Insulation	1 Layers of tape [7, 10.6 mm wide] for insulation.
Copper Foil [10 mm wide]	Using prepared copper foil in 7.4, start at Pin 3 wind 1 turn. Apply insulation tape of [7, 10.6 mm wide] before the end to avoid short circuit.
Insulation	1 Layers of tape [7, 10.6 mm wide] for insulation.
WD #3 Secondary Winding	Start at pin 11 and 12, wind 3 turns of item [6] with 5 wire parallel. from right to left. Wind uniformly, in a single layer across entire bobbin evenly. Finish on pin 9, 10.
Insulation	1 Layers of tape [7, 10.6 mm wide] for insulation.
Copper Foil [10 mm wide]	Using prepared copper foil in 7.4, start at Pin 3 wind 1 turn. Apply insulation tape of [7, 10.6 mm wide] before the end to avoid short circuit.
Insulation	1 Layers of tape [7, 10.6 mm wide] for insulation.

WD#4 ½ Primary winding	Start at pin 2, wind 14 turns of item [3] from left to right. Finish at pin 3
Insulation [16 mm wide]	3 Layers of tape [7] for insulation.
Core Assembly	Assemble and secure core halves.
Balley band [12.6 mm wide]	Put one turn of copper contacting the core. Leave 22 AWG wire 50mm long for being connected to primary ground.
Varnish	Varnish

8 Transformer Spreadsheets

ACDC_TOPSwitchGX_03
2204; Rev.1.9; Copyright
Power Integrations Inc.
2004

INPUT INFO INFO OUTP OUTP UNIT
UT UT

TOP_GX_FX_032204.xls: TOPSwitch-GX/FX
Continuous/Discontinuous Flyback Transformer
Design Spreadsheet

ENTER APPLICATION

VARIABLES

VACMIN	90	Volts	Minimum AC Input Voltage
VACMAX	265	Volts	Maximum AC Input Voltage
fL	50	Hertz	AC Mains Frequency
VO	10	Volts	Output Voltage
PO	30	Watts	Output Power
n	0.8		Efficiency Estimate
Z	0.5		Loss Allocation Factor
VB	15	Volts	Bias Voltage
tC	3	mSeco	Bridge Rectifier Conduction Time Estimate
CIN	80	uFarad	Input Filter Capacitor

ENTER TOPSWITCH-GX VARIABLES

TOP-GX

TOP-GX	TOP24	Univer	115 Doubled/230V
Chosen Device	5	sal	60W 85W
		Power	Power
		Out	Out
KL	0.72		External Ilimit reduction factor (KI=1.0 for default ILIMIT, KI <1.0 for lower ILIMIT)
ILIMITMIN		1.166	1.166 Amps
ILIMITMAX		1.426	1.426 Amps
Frequency (F)=132kHz, (H)=66kHz	F		Use 1% resistor in setting external ILIMIT Use 1% resistor in setting external ILIMIT Full (F) frequency option - 132kHz
fS		13200	13200 Hertz
fSmin		0	0 Hertz
fSmax		14000	14000 Hertz
VOR	97	Volts	Reflected Output Voltage
VDS	10	Volts	TOPSwitch on-state Drain to Source Voltage
VD	0.5	Volts	Output Winding Diode Forward Voltage Drop
VDB	0.7	Volts	Bias Winding Diode Forward Voltage Drop
KP	0.6		Ripple to Peak Current Ratio (0.4 < KRP < 1.0 : 1.0 < KDP < 6.0)

ENTER TRANSFORMER CORE/CONSTRUCTION VARIABLES

Core Type

Core Type	eer28			
Core		EER28	EER28	P/N: PC40EER28-Z
Bobbin		EER28	EER28_BOBB	P/N: BEER-28-1112CPH
		_BOBB	N	
		IN		
AE	1.18	1.18	1.18 cm^2	Core Effective Cross Sectional Area
LE	5.55	5.55	5.55 cm	Core Effective Path Length
AL	4600	4600	4600 nH/T^2	Ungapped Core Effective Inductance
BW	12.7	12.7	12.7 mm	Bobbin Physical Winding Width
M			mm	Safety Margin Width (Half the Primary to Secondary Creepage Distance)



L		1		Number of Primary Layers
NS		3		Number of Secondary Turns
DC INPUT VOLTAGE PARAMETERS				
VMIN	98	98 Volts		Minimum DC Input Voltage
VMAX	375	375 Volts		Maximum DC Input Voltage
CURRENT WAVEFORM SHAPE PARAMETERS				
DMAX	0.52	0.52		Maximum Duty Cycle
Iavg	0.38	0.38 Amps		Average Primary Current
IP	1.04	1.04 Amps		Peak Primary Current
IR	0.63	0.63 Amps		Primary Ripple Current
IRMS	0.54	0.54 Amps		Primary RMS Current
TRANSFORMER PRIMARY DESIGN PARAMETERS				
LP	597	597 uHenries		Primary Inductance
NP	28	28		Primary Winding Number of Turns
NB	4	4		Bias Winding Number of Turns
ALG	777	777 nH/T ²		Gapped Core Effective Inductance
BM	1902	1902 Gauss		Maximum Flux Density at PO, VMIN (BM<3000)
BP	2603	2603 Gauss		Peak Flux Density (BP<4200)
BAC	571	571 Gauss		AC Flux Density for Core Loss Curves (0.5 X Peak to Peak)
ur	1722	1722		Relative Permeability of Ungapped Core
LG	0.16	0.16 mm		Gap Length (Lg > 0.1 mm)
BWE	12.7	12.7 mm		Effective Bobbin Width
OD	0.46	0.46 mm		Maximum Primary Wire Diameter including insulation
INS	0.06	0.06 mm		Estimated Total Insulation Thickness (= 2 * film thickness)
DIA	0.39	0.39 mm		Bare conductor diameter
AWG	27	27 AWG		Primary Wire Gauge (Rounded to next smaller standard AWG value)
CM	203	203 Cmils		Bare conductor effective area in circular mils
CMA	374	374 Cmils/Amp		Primary Winding Current Capacity (200 < CMA < 500)
TRANSFORMER SECONDARY DESIGN PARAMETERS (SINGLE OUTPUT / SINGLE OUTPUT EQUIVALENT)				
Lumped parameters				
ISP	9.62	9.62 Amps		Peak Secondary Current
ISRMS	4.79	4.79 Amps		Secondary RMS Current
IO	3.00	3.00 Amps		Power Supply Output Current
IRIPPLE	3.73	3.73 Amps		Output Capacitor RMS Ripple Current
CMS	958	958 Cmils		Secondary Bare Conductor minimum circular mils
AWGS	20	20 AWG		Secondary Wire Gauge (Rounded up to next larger standard AWG value)
DIAS	0.81	0.81 mm		Secondary Minimum Bare Conductor Diameter
ODS	4.23	4.23 mm		Secondary Maximum Outside Diameter for Triple Insulated Wire
INSS	1.71	1.71 mm		Maximum Secondary Insulation Wall Thickness
VOLTAGE STRESS PARAMETERS				
VDRAIN	598	598 Volts		Maximum Drain Voltage Estimate (Includes Effect of Leakage Inductance)
PIVS	51	51 Volts		Output Rectifier Maximum Peak Inverse Voltage
PIVB	76	76 Volts		Bias Rectifier Maximum Peak Inverse Voltage



9 Performance Data

All measurements performed at room temperature, 60 Hz input frequency. The data were taken at the end of the output cable. The DC resistance of the cable is about 0.05 ohm.

9.1 Efficiency

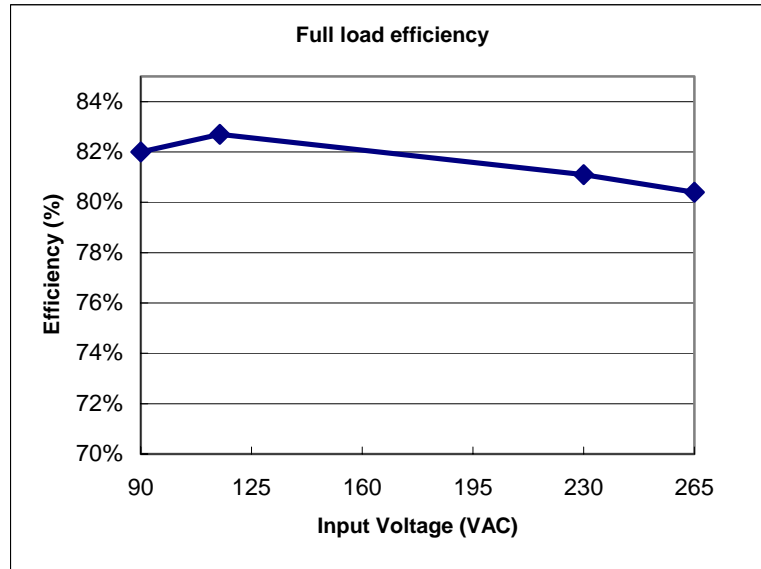

Figure 4 – Efficiency vs input voltage

9.2 No-Load Input Power Integrations

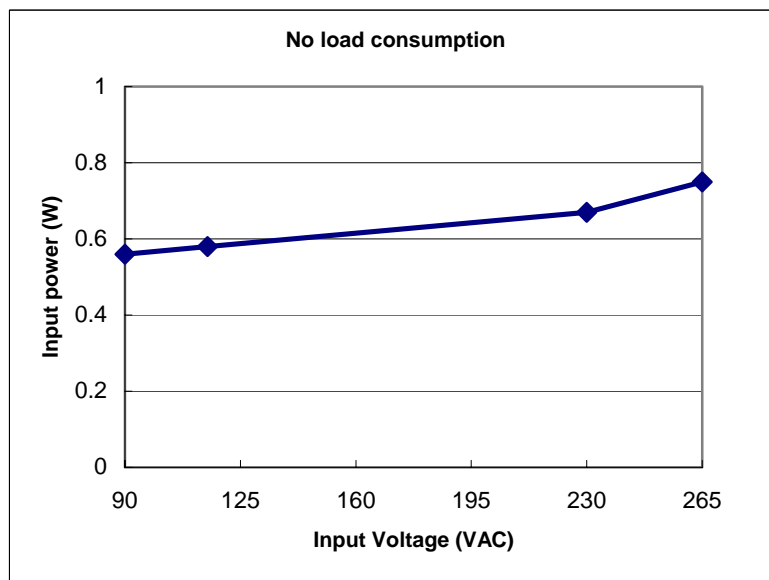

Figure 5 – No-load input vs input voltage, room temperature



9.3 Output regulation

9.3.1 Line regulation

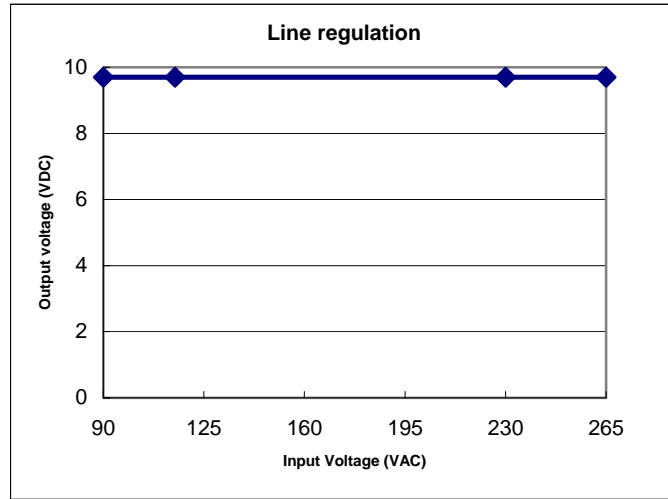

Figure 6 – Output voltage vs input voltage at 3.0 A load

9.3.2 Load regulation (taken at the end of the output cable)

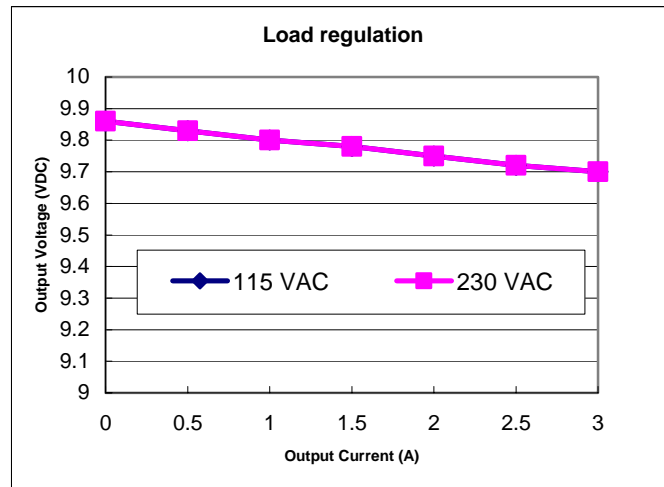

Figure 7 – Output voltage vs current

9.4 Thermal Performance

Thermal was measured inside the sealed case, at worst case, which is at high line 265 VAC input, 3.0 A load. PSU was placed in still air, with ambient temperature of 42°C.

Item	265 VAC
Ambient	42 °C
TOP245Y	101 °C



9.5 Maximum output current

This is the load current beyond which the PSU goes into auto-restart.

Item	Max. Io
115 VAC	3.76 A
230 VAC	3.83 A

10 Waveforms

10.1 Drain Voltage, Normal Operation

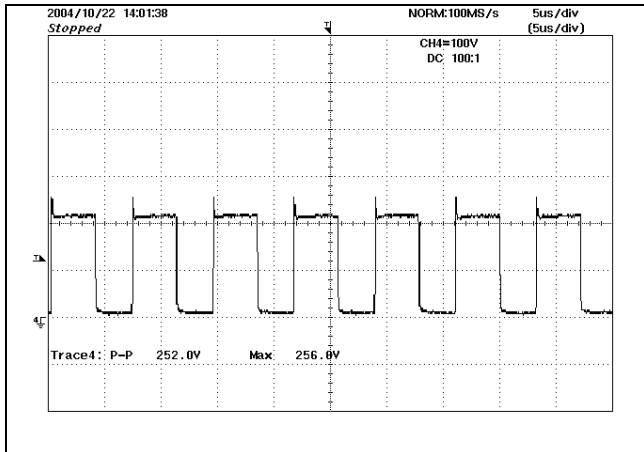

Figure 8 – Drain voltage, 90 VAC input, 3.0 A load

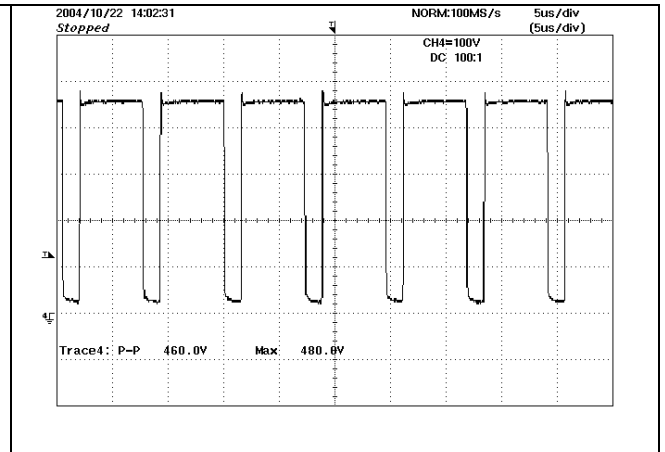

Figure 9 – Drain voltage 265 VAC, 3.0 A load

10.2 Output Voltage Start-up Profile

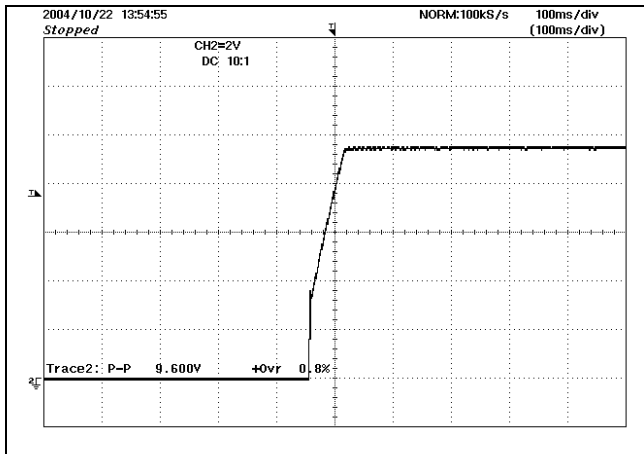

Figure 10 – 115 VAC input, 3.0 A load

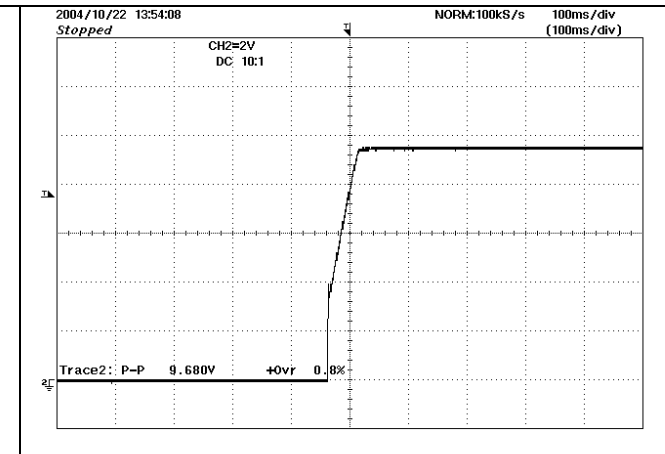

Figure 11 – 230 VAC, 3.0 A load



11 Output Ripple Measurements

11.1.1 Ripple Measurement Technique

For DC output ripple measurements, a modified oscilloscope test probe must be utilized in order to reduce spurious signals due to pickup. Details of the probe modification are provided in Figure 12 and Figure 13.

The 5125BA probe adapter is affixed with two capacitors tied in parallel across the probe tip. The capacitors include one (1) 0.1 $\mu\text{F}/50\text{ V}$ ceramic type and one (1) 1.0 $\mu\text{F}/50\text{ V}$ aluminum electrolytic. ***The aluminum electrolytic type capacitor is polarized, so proper polarity across DC outputs must be maintained (see below).***

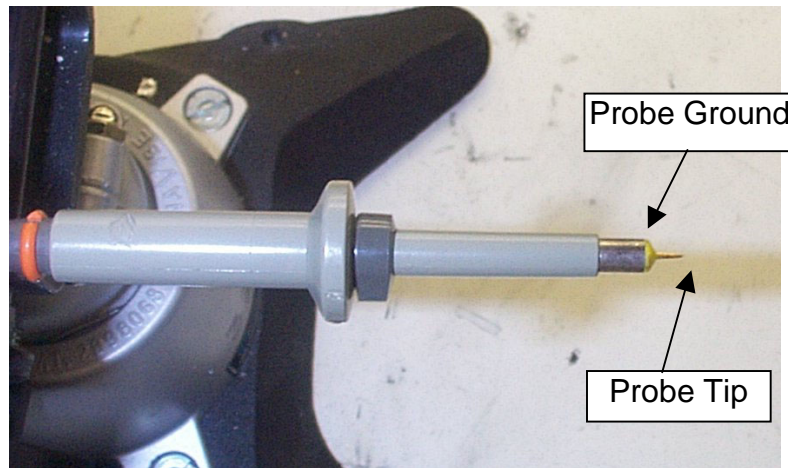

Figure 12 – Oscilloscope Probe Prepared for Ripple Measurement. (End Cap and Ground Lead Removed)

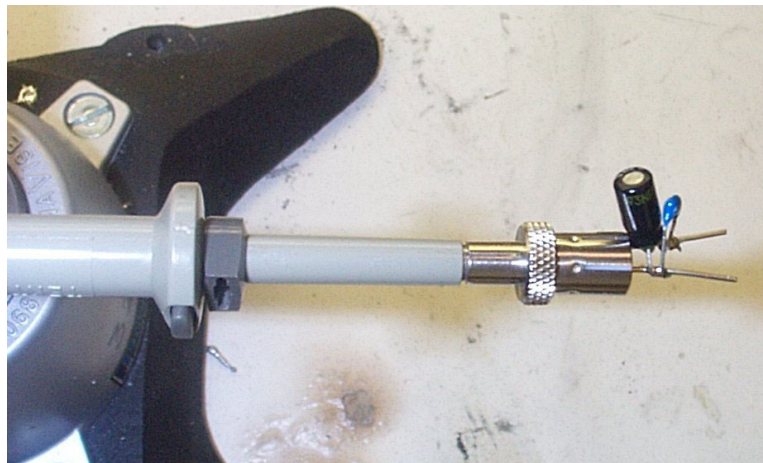

Figure 13 – Oscilloscope Probe with Probe Master 5125BA BNC Adapter. (Modified with wires for probe ground for ripple measurement, and two parallel decoupling capacitors added)

11.1.2 Measurement Results

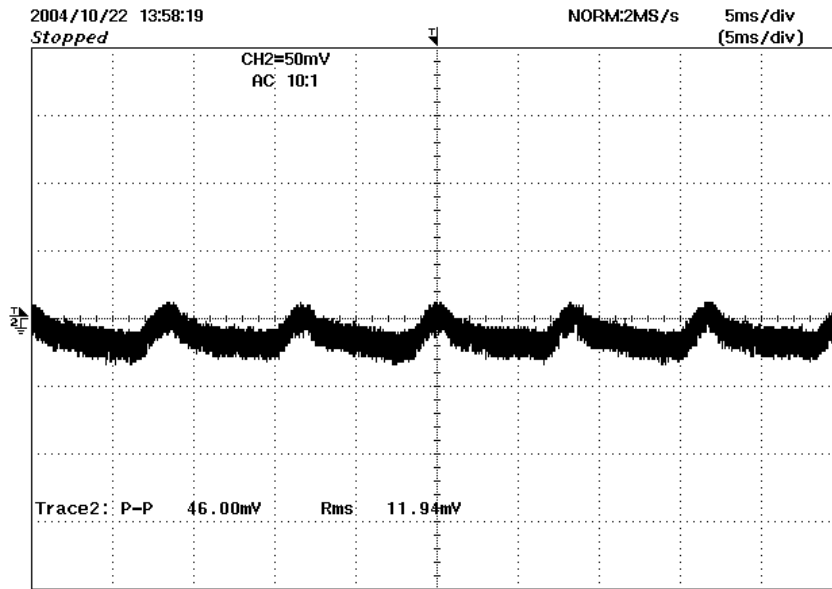

Figure 14 – Output Ripple, 115 VAC, 3.0 A load

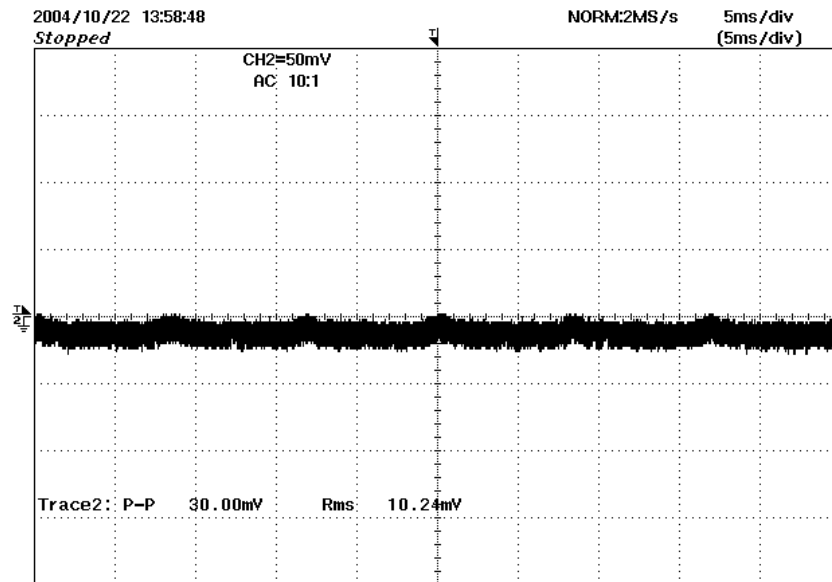

Figure 15 – Output Ripple, 230 VAC, 3.0 A load



12 Loop performance

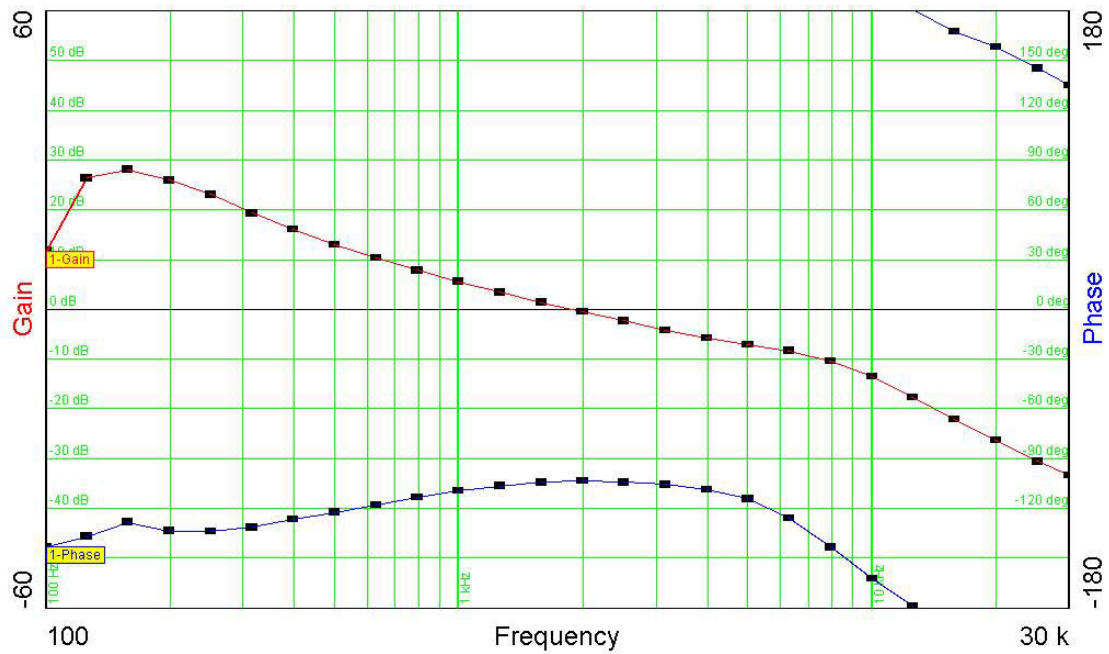

Figure 16 – Gain/phase at 115 VAC input, 3.0 A load

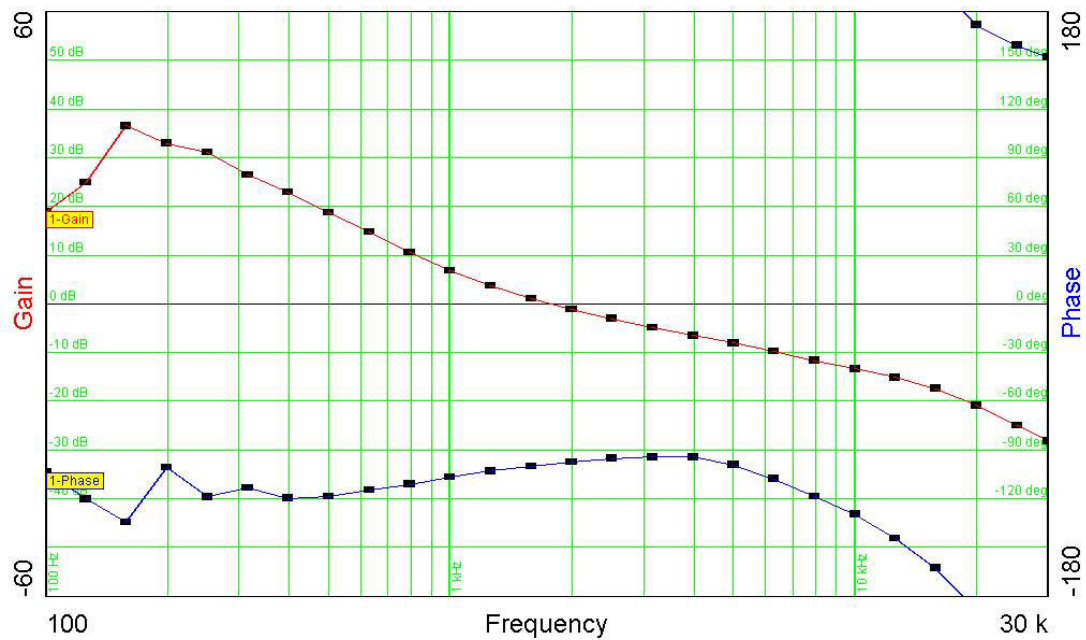

Figure 17 – Gain/Phase at 230 VAC input, 3.0 A load



13 Conducted EMI

EMI was tested at 230 VAC input, 3.0 A resistive load. The worst case result occurs at 230VAC input with artificial hand.

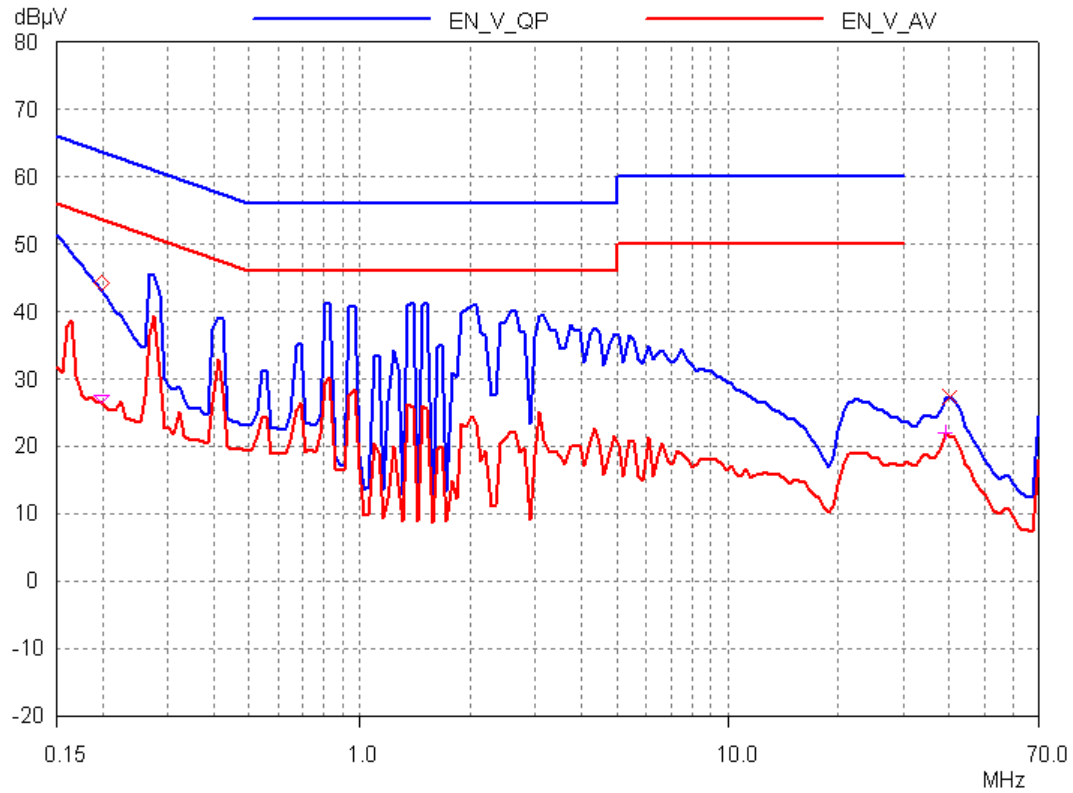

Figure 18 – Worst case conducted EMI, 230VAC, 3.0 A load



14 Revision History

Date	Author	Revision	Description & changes	Reviewed
September 12, 2005	YG	1.0	First Release	VC / AM



For the latest updates, visit our Web site: www.powerint.com

Power Integrations may make changes to its products at any time. Power Integrations has no liability arising from your use of any information, device or circuit described herein nor does it convey any license under its patent rights or the rights of others. POWER INTEGRATIONS MAKES NO WARRANTIES HEREIN AND SPECIFICALLY DISCLAIMS ALL WARRANTIES INCLUDING, WITHOUT LIMITATION, THE IMPLIED WARRANTIES OF MERCHANTABILITY, FITNESS FOR A PARTICULAR PURPOSE, AND NON-INFRINGEMENT OF THIRD PARTY RIGHTS.

PATENT INFORMATION

The products and applications illustrated herein (including circuits external to the products and transformer construction) may be covered by one or more U.S. and foreign patents or potentially by pending U.S. and foreign patent applications assigned to Power Integrations. A complete list of Power Integrations' patents may be found at www.powerint.com.

The PI Logo, **TOPSwitch**, **TinySwitch**, **LinkSwitch**, and **EcoSmart** are registered trademarks of Power Integrations. **PI Expert** and **DPA-Switch** are trademarks of Power Integrations.

© Copyright 2004, Power Integrations.

Power Integrations Worldwide Sales Support Locations

WORLD HEADQUARTERS

5245 Hellyer Avenue,
San Jose, CA 95138, USA
Main: +1-408-414-9200
Customer Service:
Phone: +1-408-414-9665
Fax: +1-408-414-9765
e-mail:
usasales@powerint.com

GERMANY

Rueckertstrasse 3,
D-80336, Munich, Germany
Phone: +49-895-527-3910
Fax: +49-895-527-3920
e-mail: eurossales@powerint.com

JAPAN

Keihin-Tatemono 1st Bldg.
12-20 Shin-Yokohama,
2-Chome,
Kohoku-ku, Yokohama-shi,
Kanagawa 222-0033, Japan
Phone: +81-45-471-1021
Fax: +81-45-471-3717
e-mail:
japansales@powerint.com

TAIWAN

17F-3, No. 510,
Chung Hsiao E. Rd., Sec. 5,
Taipei, Taiwan 110, R.O.C.
Phone: +886-2-2727-1221
Fax: +886-2-2727-1223
e-mail:
taiwansales@powerint.com

CHINA (SHANGHAI)

Rm 807, Pacheer,
Commercial Centre,
555 Nanjing West Road,
Shanghai, 200041, China
Phone: +86-21-6215-5548
Fax: +86-21-6215-2468
e-mail:
chinasales@powerint.com

INDIA (TECHNICAL SUPPORT)

Innovatech
261/A, Ground Floor
7th Main, 17th Cross,
Sadashivanagar
Bangalore, India, 560080
Phone: +91-80-5113-8020
Fax: +91-80-5113-8023
e-mail: indiasales@powerint.com

KOREA

8th Floor, DongSung Bldg.
17-8 Yoido-dong,
Youngdeungpo-gu,
Seoul, 150-874, Korea
Phone: +82-2-782-2840
Fax: +82-2-782-4427
e-mail:
koreasales@powerint.com

UK (EUROPE & AFRICA HEADQUARTERS)

1st Floor, St. James's House
East Street
Farnham, Surrey GU9 7TJ
United Kingdom
Phone: +44-1252-730-140
Fax: +44-1252-727-689
e-mail: eurossales@powerint.com

CHINA (SHENZHEN)

Rm# 1705, Bao Hua Bldg.
1016 Hua Qiang Bei Lu,
Shenzhen, Guangdong,
518031, China
Phone: +86-755-8367-5143
Fax: +86-755-8377-9610
e-mail:
chinasales@powerint.com

ITALY

Via Vittorio Veneto 12, Bresso,
Milano,
20091, Italy
Phone: +39-028-928-6001
Fax: +39-028-928-6009
e-mail: eurossales@powerint.com

SINGAPORE

51 Newton Road,
#15-08/10 Goldhill Plaza,
Singapore, 308900
Phone: +65-6358-2160
Fax: +65-6358-2015
e-mail:
singaporesales@powerint.com

APPLICATIONS HOTLINE

World Wide +1-408-414-9660

APPLICATIONS FAX

World Wide +1-408-414-9760

ER or EPR template – Rev 3.6 – Single sided

