

# COMPACT HIGH POWER RELAY

## For automotive applications

### 1 POLE - 60A (For 12V Car Battery)

## FBR59-HW Series

### ■ FEATURES

- 1 pole, 60A, 1 form U
- High temperature grade (-40°C to 125°C)
- Comparable capability with Power Mini ISO plug-in relays
- Through hole reflow type available
- RoHS compliant, lead free

Please see page 4 for more information

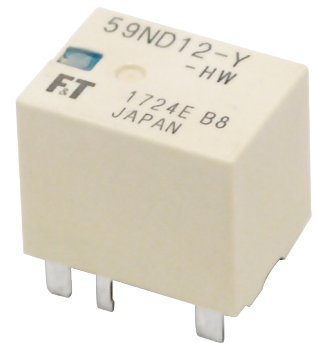

### ■ Part Numbers

[Example]    FBR59    N    D12    -    Y    -    HW    -    RW  
                   (a)        (b)        (c)        (d)        (e)        (f)

(a)	Relay type	FBR59	: FBR59 series
(b)	Enclosure	N	: Plastic sealed type
(c)	Coil rated voltage	D12	: 9...12VDC Coil rating table at page 3
(d)	Contact material	Y	: Silver-tin oxide
(e)	Contact rating	HW	: 60A
(f)	Soldering	Nil	: Standard
		RW	: Through hole reflow (THR)

Actual markings does not carry the type name: "FBR"

E.g.: Ordering code: FBR59ND12-Y-HW Actual marking: 59ND12-Y-HW

# FBR59-HW Series

## ■ Specifications

Item			FBR59-HW	
				Remarks / conditions
Contact data	Configuration		1 form U	
	Construction		Single	
	Material		Silver-tin oxide	
	Voltage drop		Max. 100 mV	At 1A, 12VDC
	Contact rating		60A, 14VDC 45A, 14VDC	Resistive load Motor load
	Max. carrying current		60A / 1h	At 25 deg C, rated load
	Max. inrush current		220A	Capacitor inrush based
	Min. switching load *		1A 6VDC	Reference
	Max. switching load **		60A, 14VDC 45A, 14VDC	Resistive load Motor load
Coil	Operating temperature range		-40°C ~ +125°C	No frost
Timing data	Operate		Max. 10ms	At nominal voltage (without diode, without bounce)
	Release		Max. 10ms	At nominal voltage (without diode, without bounce)
	Storage temperature / humidity		-40°C to 125°C, 45 to 85RH	No frost
Life	Mechanical		Min. 1 x 10 <sup>6</sup> operations	without contact load
	Electrical		Min. 100 x 10 <sup>3</sup> operations	resistive load
Insulation	Insulation resistance		Min. 100MΩ at 500VDC	Initial
	Dielectric withstanding voltage	Open contacts	500VAC (50/60Hz), 1 minute	
		Coil contact	500VAC (50/60Hz), 1 minute	
Other	Vibration resistance	Misoperation	10 to 200Hz, 44m/s <sup>2</sup> (4.5G), constant acceleration	
		Endurance	10 to 200Hz, 44m/s <sup>2</sup> (4.5G), constant acceleration	
	Shock resistance	Misoperation	Min. 100m/s <sup>2</sup> (11 ± 1ms)	
		Endurance	Min. 1,000m/s <sup>2</sup> (6 ± 1ms)	
	Dimensions / weight		15.0 x 20.0 x 16.8 mm / approx. 13g	

\*: Minimum switching loads mentioned above are reference values. Please perform the confirmation test with actual load before production since reference values may vary according to switching frequencies, environmental conditions and expected reliability levels.

\*\* : Maximum switching loads mentioned above are reference values. Please refer to operation range graph for continuous current.

Note: Values of electrical characteristics are under 15 to 35 degC, 25 to 75%RH (JIS standard condition) unless otherwise specified.

Note: Care shall be taken on the heat generated on PC board when maximum carrying current exceeds 10A.

Please perform the confirmation test with actual conditions

# FBR59-HW Series

## ■ Coil Data

Coil code	Rated Coil Voltage (VDC)	Coil Resistance +/-10% ( $\Omega$ )	Must Operate Voltage* (VDC)	Must Release Voltage* (VDC)
D09	9	170	5.4 (at 20°C) 7.7 (at 125°C)	0.7 (at 20°C) 1.0 (at 125°C)
D10	10	220	6.3 (at 20°C) 9 (at 125°C)	0.8 (at 20°C) 1.2 (at 125°C)
D12	12	320	7.3 (at 20°C) 10.4 (at 125°C)	1.0 (at 20°C) 1.5 (at 125°C)

Note: All values in the table are valid at 20°C and zero contact current, unless otherwise specified.

\*: Specified operated values are valid for pulse wave voltage.

Note: Please use at rated coil voltage. Please refer to characteristic data and set up adequate voltage in case of use at over voltage.

## ■ Dimensions

- Dimensions

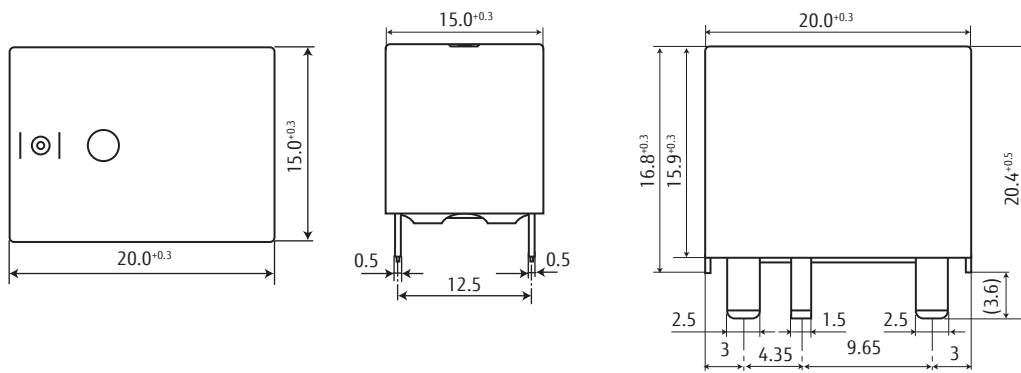

- Schematics (BOTTOM VIEW)

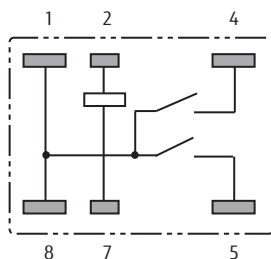

# FBR59-HW Series

- PC Board Mouting Hole Layout (BOTTOM VIEW)

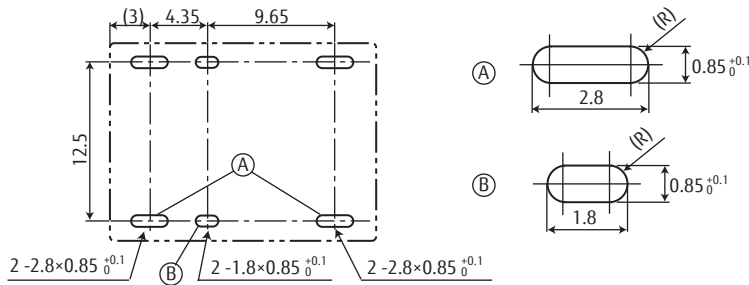

\* Dimensions of the terminals do not include thickness of pre-solder.  
 \* Tolerance of PC board mouting hole layout : ±0.1 unless otherwise specified.

( ): Reference value  
 Unit: mm

## Characteristic Data (Reference)

Distribution of operate/release voltage

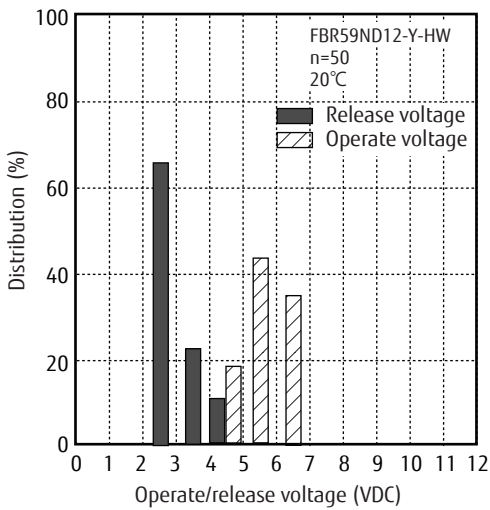

Distribution of contact resistance

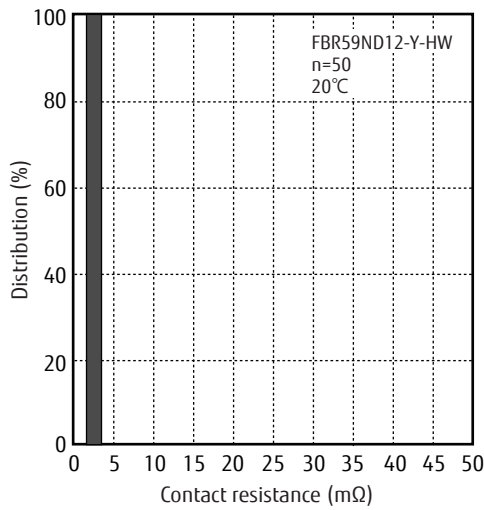

Distribution of operate/release time

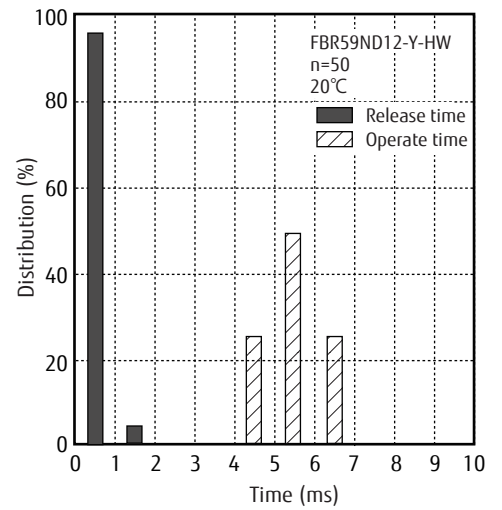

# FBR59-HW Series

Operating range

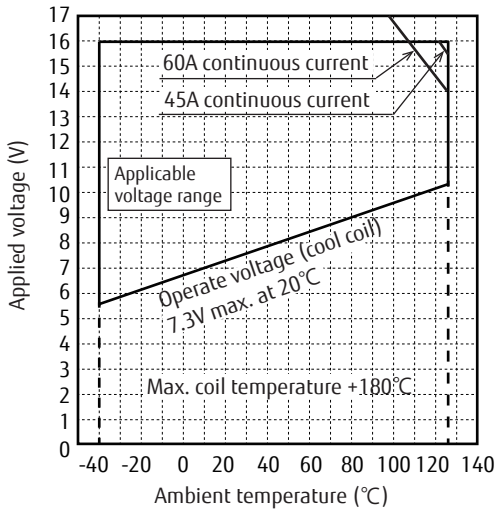

Contact current capacity

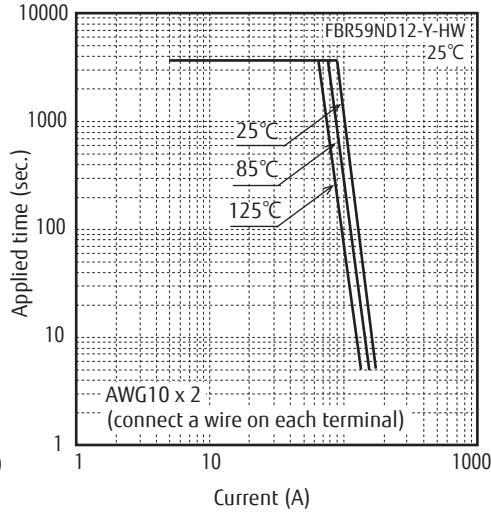

Coil temperature rise (ambient temperature 25°C)

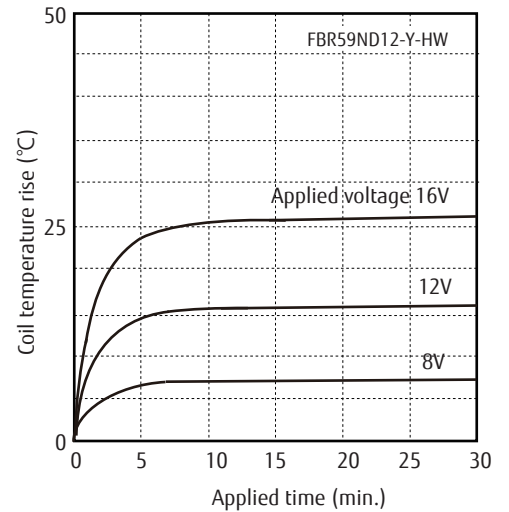

Coil temperature rise (ambient temperature 25°C)

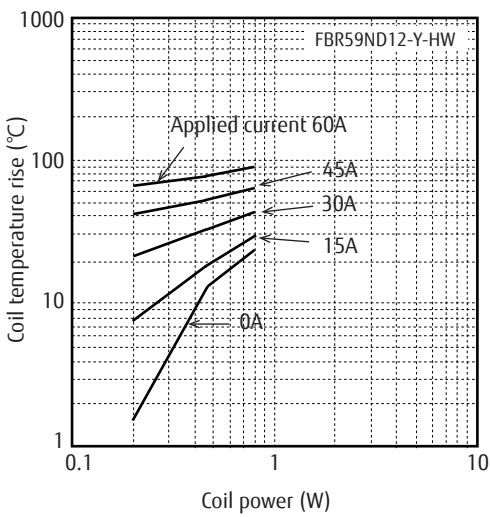

Coil temperature rise (ambient temperature 85°C)

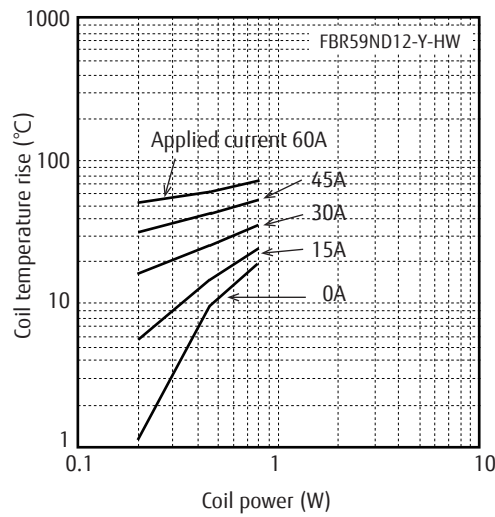

# FBR59-HW Series

## Shock resistance characteristics

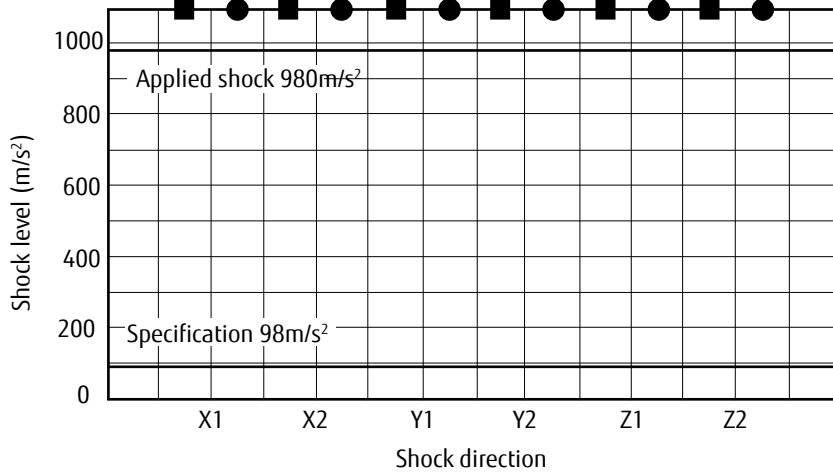

Shock application time: 6±1ms half-sine wave  
 Test conditions: Coil energized(12VDC) and de-energized  
 Shock direction: see diagram below  
 Detection level: chatter >1ms

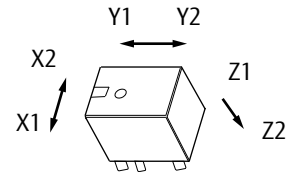

■ Make contact (coil de-energized)  
 ● Make contact (coil energized)

## Vibration resistance characteristics

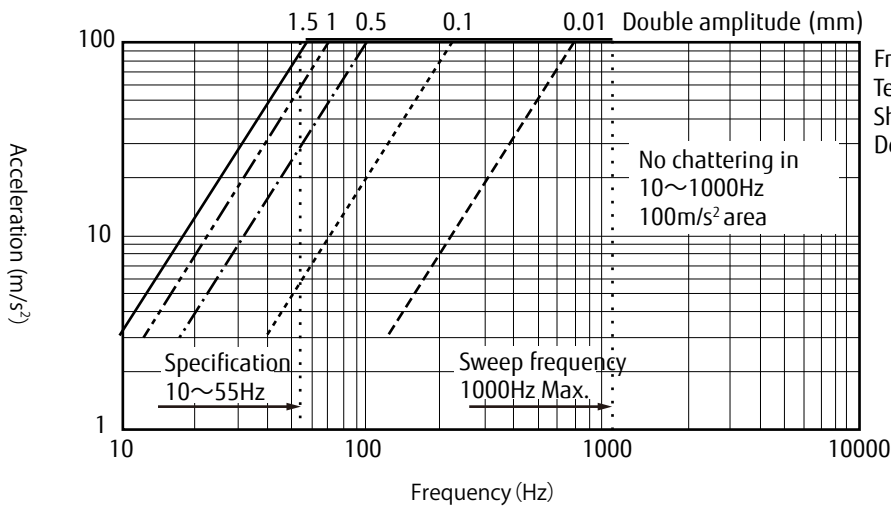

Frequency : 10 to 1000Hz  
 Test conditions: Coil energized(12VDC) and de-energized  
 Shock direction: see diagram below  
 Detection level: chatter >1ms

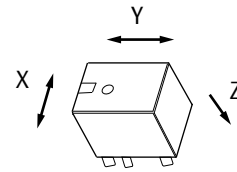

# FBR59-HW Series

## GENERAL INFORMATION

### 1. ROHS Compliance

- All relays produced by Fujitsu Components are compliant with RoHS directive 2011/65/EU including amendments.
- Use of Cadmium in electrical contacts is exempted as per Annex III of the RoHS directive 2001/65/EU. Please consider expiry date of exemption. Relays with Cadmium containing contacts are not to be used for new designs.
- All relays are lead-free. Please refer to Lead-Free Status Info for older date codes at: <http://www.fujitsu.com/downloads/MICRO/fcai/relays/lead-free-letter.pdf>
- Characteristic data is not guaranteed values, but measured values of samples from production line.

### 2. Recommended lead free solder condition

- Lead free solder plating on relay terminals is Sn-3.0Ag-0.5Cu, unless otherwise specified. This material has been verified to be compatible with PbSn assembly process.
- Recommended solder for assembly: Sn-3.0Ag-0.5Cu.

#### Flow Solder Condition:

Pre-heating: maximum 120°C  
within 90 sec.  
Soldering: dip within 5 sec. at  
255°C ± 5°C solder bath  
Relay must be cooled by air immediately  
after soldering

#### Solder by Soldering Iron:

Soldering Iron 30-60W  
Temperature: maximum 340-360°C  
Duration: maximum 3 sec.

#### Re-Flow Solder Condition:

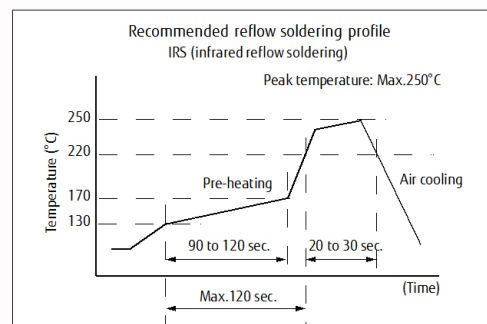

Applicable for FBR59NDxx-Y-HW-RW only

**We highly recommend that you confirm your actual solder conditions**

#### Important notes for reflow soldering:

- Temperature shall be measured at PC board upper surface
- Temperature at PC board upper surface may be changed depending on size of PC board, components mounted on the PC board and/ or heating method  
Please perform the confirmation test with your actual PC boards
- This reflow solder condition is applicable only for reflow-capable relays. Do not reflow reflow-incapable relays
- Recommended solder for assembly: Sn-3.0 Ag-0.5 Cu.

### 3. Moisture Sensitivity

- Moisture Sensitivity Level standard is not applicable to electromechanical relays, unless otherwise indicated. -RW THR relay will be shipped in moisture barrier bag.

### 4. Tin Whiskers

- Dipped SnAgCu solder is known as presenting a low risk to tin whisker development. No considerable length whisker was found by our in house test.

# FBR59-HW Series

## Fujitsu Components International Headquarter Offices

<b>Japan</b> FUJITSU COMPONENT LIMITED Shinagawa Seaside Park Tower 19F, 12-4, Higashi-shinagawa 4-chome, Shinagawa-ku, Tokyo, 140-0002, Japan Tel: (81-3) 3450-1682 Fax: (81-3) 3474-2385 Email: fcl-contact@cs.jp.fujitsu.com Web: www.fujitsu.com/jp/fcl/	<b>Asia Pacific</b> FUJITSU COMPONENTS ASIA, LTD. 102E Pasir Panjang Road #01-01 Citilink Warehouse Complex Singapore 118529 Tel: (65) 6375-8560 Fax: (65) 6273-3021 Email: fcal@sg.fujitsu.com Web: www.fujitsu.com/sg/products/devices/components	<b>Korea</b> FUJITSU COMPONENTS KOREA LIMITED Alpha Tower #403, 645 Samsyeong-dong, Bundang-gu, Seongnam-si, Gyeonggi-do, 13524 Korea Tel: (82) 31-708-7108 Fax: (82) 31-709-7108 Email: fcal@sg.fujitsu.com www.fujitsu.com/sg/products/devices/components/
<b>North and South America</b> FUJITSU COMPONENTS AMERICA, INC 2290 North First Street, Suite 212 San Jose, CA 95131, USA Tel: (1-408) 745-4900 Fax: (1-408) 745-4970 Email: components@us.fujitsu.com Web: us.fujitsu.com/components	<b>China</b> FUJITSU ELECTRONIC COMPONENTS (SHANGHAI) CO., LTD. Unit 4306, InterContinental Center 100 Yu Tong Road, Shanghai 200070, China Tel: (86-21) 3253 0998 Fax: (86-21) 3253 0997 Email: fcal@sg.fujitsu.com Web: www.fujitsu.com/sg/products/devices/components	
<b>Europe</b> FUJITSU COMPONENTS EUROPE B.V. Diamantlaan 25 2132 WV Hoofddorp Netherlands Tel: (31-23) 5560910 Fax: (31-23) 5560950 Email: info@fceu.fujitsu.com Web: www.fujitsu.com/uk/components	<b>Hong Kong</b> FUJITSU COMPONENTS HONG KONG CO., LTD Unit 506, Inter-Continental Plaza No.94 Granville Road, Tsim Sha Tsui, Kowloon, Hong Kong Tel: (852) 2881-8495 Tex: (852) 2894-9512 Email: fcal@sg.fujitsu.com Web: www.fujitsu.com/sg/products/devices/components/	

©2017 Fujitsu Components Europe B.V. All rights reserved. All trademarks or registered trademarks are the property of their respective owners.

The contents, data and information in this datasheet are provided by Fujitsu Component Ltd. as a service only to its user and only for general information purposes.

The use of the contents, data and information provided in this datasheet is at the users' own risk.

Fujitsu has assembled this datasheet with care and will endeavor to keep the contents, data and information correct, accurate, comprehensive, complete and up to date.

Fujitsu Components Europe B.V. and affiliated companies do however not accept any responsibility or liability on their behalf, nor on behalf of its employees, for any loss or damage, direct, indirect or consequential, with respect to this datasheet, its contents, data, and information and related graphics and the correctness, reliability, accuracy, comprehensiveness, usefulness, availability and completeness thereof.

Nor do Fujitsu Components Europe B.V. and affiliated companies accept on their behalf, nor on behalf of its employees, any responsibility or liability for any representation or warrant of any kind, express or implied, including warranties of any kind for merchantability or fitness for particular use, with respect to these datasheets, its contents, data, information and related graphics and the correctness, reliability, accuracy, comprehensiveness, usefulness, availability and completeness thereof. Rev. August 14<sup>th</sup>, 2017