

# FG3000DV-90DA

HIGH POWER INVERTER USE  
PRESS PACK TYPE

**FG3000DV-90DA**



- ITQRM Repetitive controllable on-state current ..... 3000A
- IT(AV) Average on-state current ..... 950A
- VDRM Repetitive peak off state voltage ..... 4500V
- Anode short type

**OUTLINE DRAWING**

Dimensions in mm

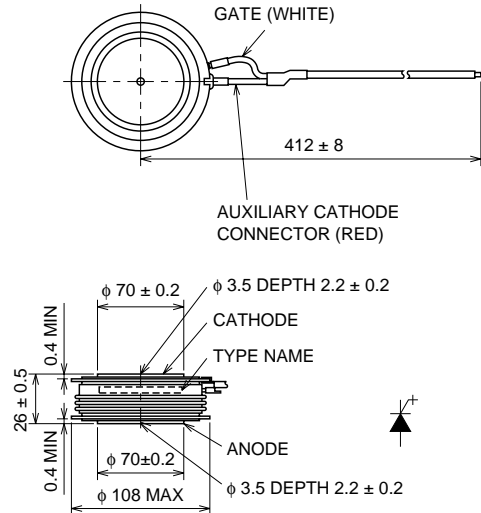

## APPLICATION

Inverters, D.C. choppers, Induction heaters, D.C. to D.C. converters.

## MAXIMUM RATINGS

Symbol	Parameter	Voltage class		Unit
		90DA		
VRRM	Repetitive peak reverse voltage	17		V
VRSM	Non-repetitive peak reverse voltage	17		V
VR(DC)	DC reverse voltage	17		V
VDRM	Repetitive peak off-state voltage*	4500		V
VDSM	Non-repetitive peak off-state voltage*	4500		V
VD(DC)	DC off-state voltage*	2500		V

\* : VGK = -2V

Symbol	Parameter	Conditions	Ratings	Unit
ITQRM	Repetitive controllable on-state current	V <sub>DM</sub> = 3375V, T <sub>j</sub> = 125°C, C <sub>s</sub> = 6.0μF, L <sub>s</sub> = 0.3μH	3000	A
IT(RMS)	RMS on-state current		1490	A
IT(AV)	Average on-state current	f = 60Hz, sine wave θ = 180°, T <sub>i</sub> = 71°C	950	A
ITSM	Surge (non-repetitive) on-state current	One half cycle at 60Hz	17	kA
I <sup>2</sup> t	Current-squared, time integration	One cycle at 60Hz	1.2 × 10 <sup>6</sup>	A <sup>2</sup> s
diT/dt	Critical rate of rise of on-state current	V <sub>D</sub> = 2250V, I <sub>GM</sub> = 40A, T <sub>j</sub> = 125°C	500	A/μs
VFGM	Peak forward gate voltage		10	V
VRGM	Peak reverse gate voltage		17	V
IFGM	Peak forward gate current		100	A
IRGM	Peak gate reverse current		900	A
PFGM	Peak forward gate power dissipation		400	W
PRGM	Peak reverse gate power dissipation		27	kW
PFG(AV)	Average forward gate power dissipation		100	W
PRG(AV)	Average reverse gate power dissipation		230	W
T <sub>j</sub>	Junction temperature		-40 ~ +125	°C
T <sub>stg</sub>	Storage temperature		-40 ~ +150	°C
—	Mounting force required	Recommended value 33	30 ~ 40	kN
—	Weight	Standard value	1220	g

# FG3000DV-90DA

HIGH POWER INVERTER USE  
PRESS PACK TYPE

## ELECTRICAL CHARACTERISTICS

Symbol	Parameter	Test conditions	Limits			Unit
			Min	Typ	Max	
V <sub>TM</sub>	On-state voltage	T <sub>j</sub> = 125°C, I <sub>TM</sub> = 3000A, Instantaneous measurement	—	—	4.0	V
I <sub>RRM</sub>	Repetitive peak reverse current	T <sub>j</sub> = 125°C, V <sub>RRM</sub> Applied	—	—	300	mA
I <sub>DRM</sub>	Repetitive peak off-state current	T <sub>j</sub> = 125°C, V <sub>DRM</sub> Applied, V <sub>GK</sub> = -2V	—	—	150	mA
I <sub>RG</sub>	Reverse gate current	T <sub>j</sub> = 125°C, V <sub>RG</sub> = 17V	—	—	300	mA
dv/dt	Critical rate of rise of off-state voltage	T <sub>j</sub> = 125°C, V <sub>D</sub> = 2250V, V <sub>GK</sub> = -2V	1000	—	—	V/μs
t <sub>gt</sub>	Turn-on time	T <sub>j</sub> = 125°C, I <sub>TM</sub> = 3000A, I <sub>GM</sub> = 40A, V <sub>D</sub> = 2250V	—	—	10	μs
t <sub>gq</sub>	Turn-off time	T <sub>j</sub> = 125°C, I <sub>TM</sub> = 3000A, V <sub>DM</sub> = 3375V, diGQ/dt = -40A/μs V <sub>RG</sub> = 17V, C <sub>s</sub> = 6.0μF, L <sub>s</sub> = 0.3μH	—	—	30	μs
I <sub>GQM</sub>	Peak gate turn-off current		—	670	—	A
V <sub>GT</sub>	Gate trigger voltage	DC METHOD : V <sub>D</sub> = 24V, R <sub>L</sub> = 0.1Ω, T <sub>j</sub> = 25°C	—	—	1.5	V
I <sub>GT</sub>	Gate trigger current		—	—	4000	mA
R <sub>th(j-f)</sub>	Thermal resistance	Junction to fin	—	—	0.015	°C/W

## PERFORMANCE CURVES

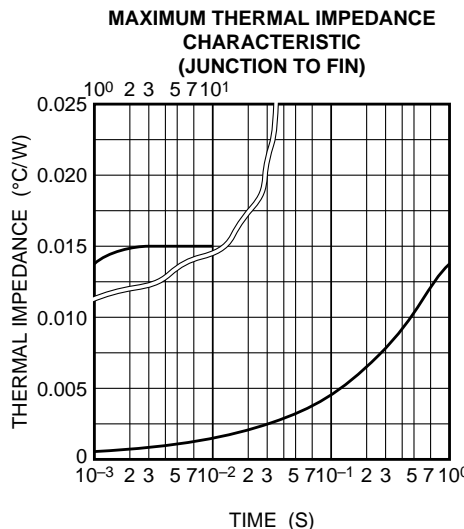
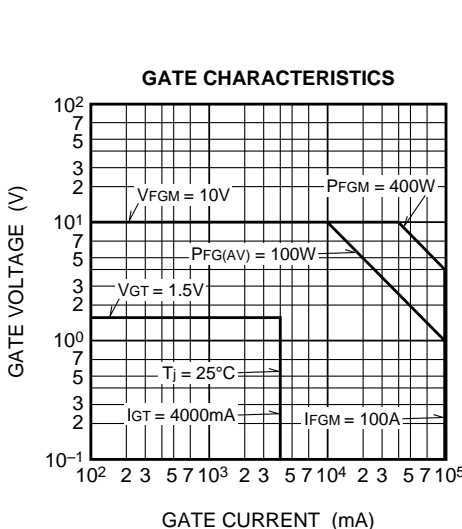
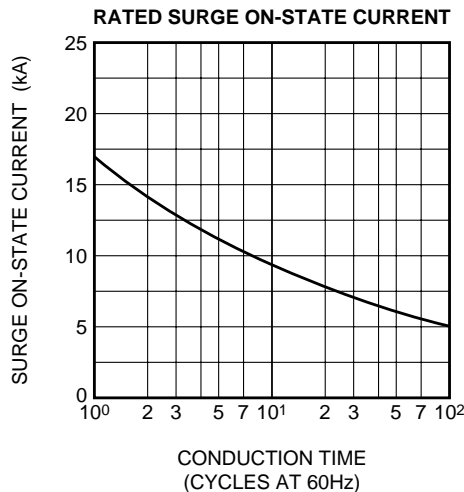
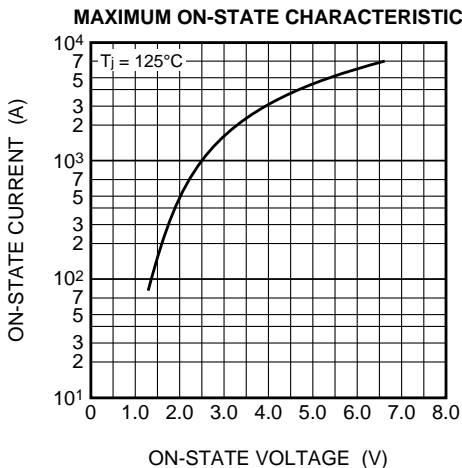

# FG3000DV-90DA

HIGH POWER INVERTER USE  
PRESS PACK TYPE

**MAXIMUM ON-STATE POWER DISSIPATION CHARACTERISTICS (SINGLE-PHASE HALF WAVE)**

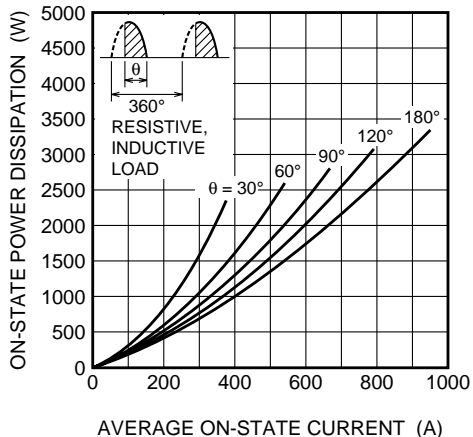

**ALLOWABLE FIN TEMPERATURE VS. AVERAGE ON-STATE CURRENT (SINGLE-PHASE HALF WAVE)**

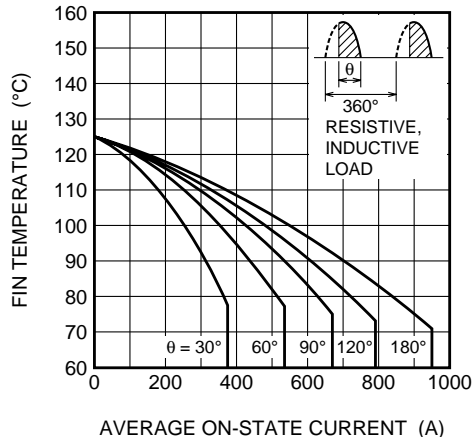

**MAXIMUM ON-STATE POWER DISSIPATION CHARACTERISTICS (RECTANGULAR WAVE)**

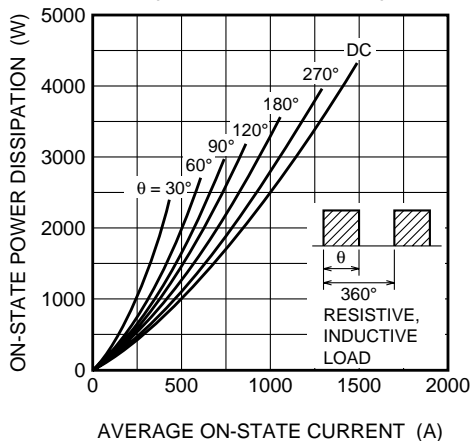

**ALLOWABLE FIN TEMPERATURE VS. AVERAGE ON-STATE CURRENT (RECTANGULAR WAVE)**

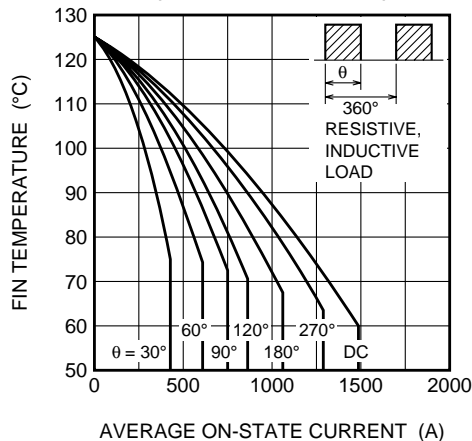

**GATE TRIGGER CURRENT VS. JUNCTION TEMPERATURE (TYPICAL)**

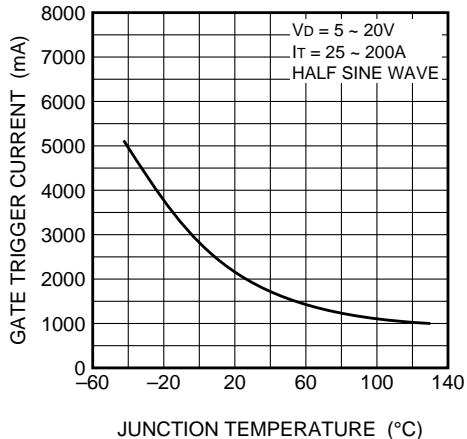

**TURN ON TIME, TURN ON DELAY TIME VS. TURN ON GATE CURRENT (TYPICAL)**

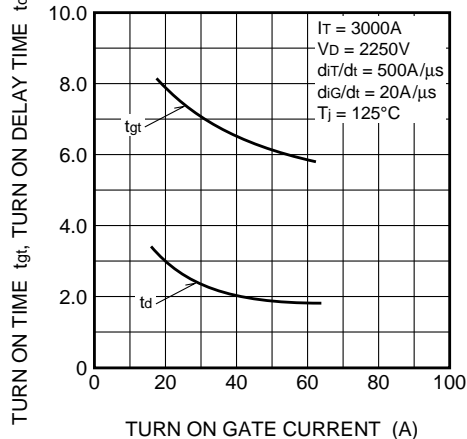

# FG3000DV-90DA

HIGH POWER INVERTER USE  
PRESS PACK TYPE

