



Features

- InGaAs/InP PIN Photodiode with transimpedance amplifier
- High Sensitivity
- Single +3.3V operation
- -40~85 °C operating temperature
- For Single-mode and Multi-mode Application
- High Speed
- 8 Pin Package with ST Port
- ATM receiver / transceiver
- Fast ethernet receiver / transceiver
- RoHS Compliant available

Absolute Maximum Ratings (Tc=25 °C)

Parameter	Symbol	Rating	Unit
Supply Voltage	V _{CC}	6	V
Operating Temperature	T _{opr}	-40 ~ 85	
Storage Temperature	T _{stg}	-40 ~ 85	

DC Electrical Characteristics (Tc=25 °C)

Parameter	Symbol	Min.	Typ.	Max.	Unit
Power Supply	V _{CC}	3	3.3	3.6	V
Differential Output Voltage @ max I/P Current	V _d	-	-	1.2	V
Supply Current (no load)	I _{CC}	11	21	36	mA

(Operating at V_{CC}=3.3V , Tc=25 °C, λ =1.3 μ m, 9/125 μ m SM & 50/125 μ m MM fiber)

Optical and Electrical Characteristics (Tc=25 °C)

Parameter	Symbol	Min.	Typ.	Max.	Unit	Notes
Detection Range		1100	1310	1650	nm	-
Gain@10Mbps Single ended	G	46	-	142	V/mW	Measure differentially, AC coupled, RL=50
Bandwidth (to -3dB point)	BW	90	110	-	MHz	-
Saturation Power	P _{sat}	-3	-	-	dBm	BER<10 ⁻¹⁰ @155Mbps PRBS2 ²³ -1, E _r =10dB
Sensitivity	Sens	-	-37	-31	dBm	BER<10 ⁻¹⁰ @155Mbps PRBS2 ²³ -1, E _r =10dB
Output Resistance (Single ended)	R _{out}	32	45	65		-

- Note:**
1. Pin assignment can be custom specified.
 2. ESD precautions must be taken when handling this product.
 3. Specifications subject to change with notice.

Pinout Assignment

PIN	FUNCTION
1	N.C.
2	GND
3	Dout
4	N.C.
5	N.C.
6	VCC
7	$\overline{\text{Dout}}$
8	N.C.

Mechanic Dimension (Units in mm)

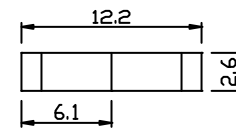
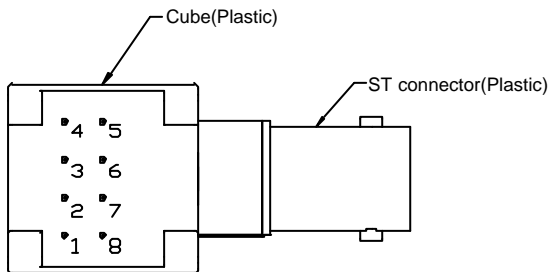
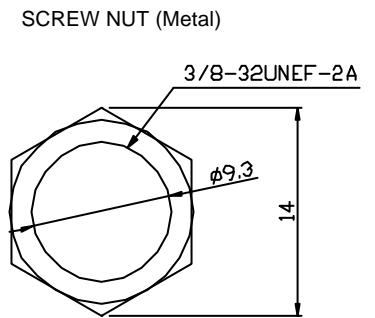
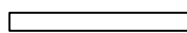
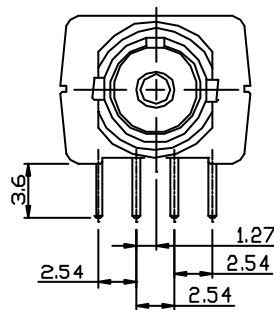
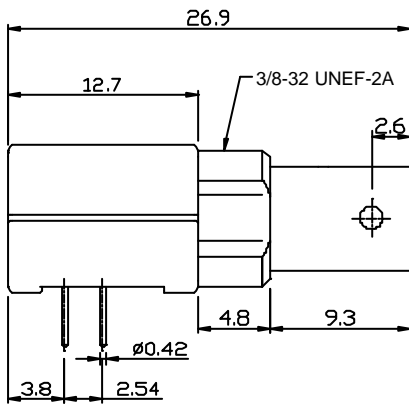
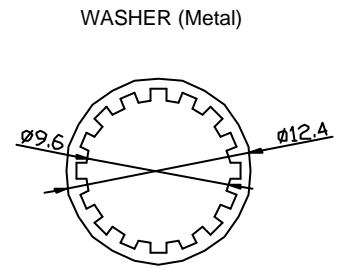
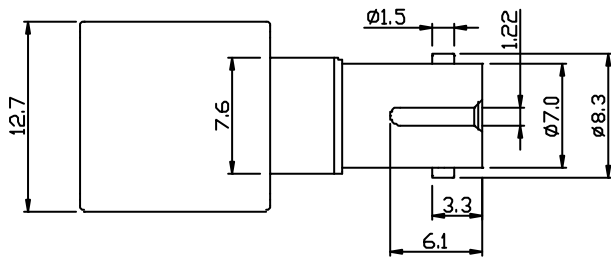

Ordering Information

T-11-2315T-08-XX

RoHS Compliant

Blank/G5/GR

Blank = RoHS non-compliant product

G5 = RoHS 5/6-compliant product (lead exemption)

GR = Full RoHS compliant product (no exemption)

Warnings

Handling Precautions: This device is susceptible to damage as a result of electrostatic discharge (ESD). A static free environment is highly recommended. Follow guidelines according to proper ESD procedures.

Laser Safety: Radiation emitted by laser devices can be dangerous to human eyes. Avoid eye exposure to direct or indirect radiation.

Legal Notice

IMPORTANT NOTICE!

All information contained in this document is subject to change without notice, at Source Photonics' s sole and absolute discretion. Source Photonics warrants performance of its products to current specifications only in accordance with the company' s standard one-year warranty; however, specifications designated as "preliminary" are given to describe components only, and Source Photonics expressly disclaims any and all warranties for said products, including express, implied, and statutory warranties, warranties of merchantability, fitness for a particular purpose, and non-infringement of proprietary rights. Please refer to the company' s Terms and Conditions of Sale for further warranty information.

Source Photonics assumes no liability for applications assistance, customer product design, software performance, or infringement of patents, services, or intellectual property described herein. No license, either express or implied, is granted under any patent right, copyright, or intellectual property right, and Source Photonics makes no representations or warranties that the product(s) described herein are free from patent, copyright, or intellectual property rights. Products described in this document are NOT intended for use in implantation or other life support applications where malfunction may result in injury or death to persons. Source Photonics customers using or selling products for use in such applications do so at their own risk and agree to fully defend and indemnify Source Photonics for any damages resulting from such use or sale.

THE INFORMATION CONTAINED IN THIS DOCUMENT IS PROVIDED ON AN "AS IS" BASIS. Customer agrees that Source Photonics is not liable for any actual, consequential, exemplary, or other damages arising directly or indirectly from any use of the information contained in this document. Customer must contact Source Photonics to obtain the latest version of this publication to verify, before placing any order, that the information contained herein is current.

© Copyright Source Photonics, Inc. 2009

All rights reserved