

**SURFACE MOUNT GLASS PASSIVATED
SUPER FAST SILICON RECTIFIER**
VOLTAGE RANGE 50 to 600 Volts CURRENT 1.0 Ampere

FEATURES

- * Glass passivated device
- * Ideal for surface mounted applications
- * Low leakage current
- * Metallurgically bonded construction
- * Halogen-free
- * P/N suffix V means AEC-Q101 qualified, e.g:ES1AV

MECHANICAL DATA

- * Epoxy : Device has UL flammability classification 94V-0
- * Mounting position: Any
- * Weight: 0.057 gram

MAXIMUM RATINGS AND ELECTRICAL CHARACTERISTICS

Ratings at 25 °C ambient temperature unless otherwise specified.
Resistive or inductive load.

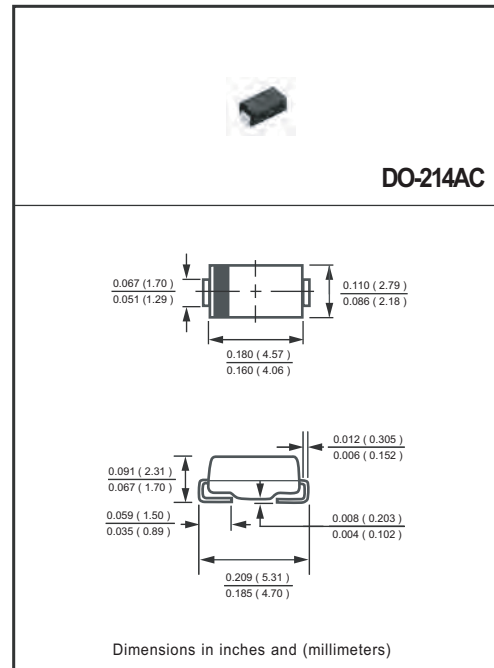

MAXIMUM RATINGS (@ TA=25 °C unless otherwise noted)

RATINGS	SYMBOL	ES1A	ES1B	ES1C	ES1D	ES1E	ES1G	ES1J	UNITS
Maximum Recurrent Peak Reverse Voltage	V _{RRM}	50	100	150	200	300	400	600	Volts
Maximum RMS Voltage	V _{RMS}	35	70	105	140	210	280	420	Volts
Maximum DC Blocking Voltage	V _{DC}	50	100	150	200	300	400	600	Volts
Maximum Average Forward Rectified Current at T _A = 55°C	I _o	1.0							Amps
Peak Forward Surge Current 8.3 ms single half sine-wave superimposed on rated load (JEDEC method)	I _{FSM}	30							Amps
Typical Current Square Time	I ² T	3.7							A ² S
Typical Thermal Resistance (Note 4)	R _{θJA}	85							°C/W
	R _{θJL}	35							
Typical Junction Capacitance (Note 2)	C _J	15					10		pF
Operating and Storage Temperature Range	T _J , T _{STG}	-55 to + 150							°C

ELECTRICAL CHARACTERISTICS (@TA=25 °C unless otherwise noted)

CHARACTERISTICS	SYMBOL	ES1A	ES1B	ES1C	ES1D	ES1E	ES1G	ES1J	UNITS	
Maximum Instantaneous Forward Voltage at 1.0ADC	V _F	0.95			1.25		1.70		Volts	
Maximum DC Reverse Current at Rated DC Blocking Voltage	I _R	@T _A = 25°C							0.5	μAmps
		@T _A = 150°C							2.0	mAmps
Maximum Reverse Recovery Time (Note 1)	t _{rr}	35							nSec	

- NOTES : 1. Reverse Recovery Test Conditions: I_F = 0.5A, I_R = -1.0A, I_{RR} = -0.25A
 2. Measured at 1 MHz and applied reverse voltage of 4.0 volts
 3. Thermal Resistance : Mounted on PCB.

RATING AND CHARACTERISTICS CURVES (ES1AV THRU ES1JV)

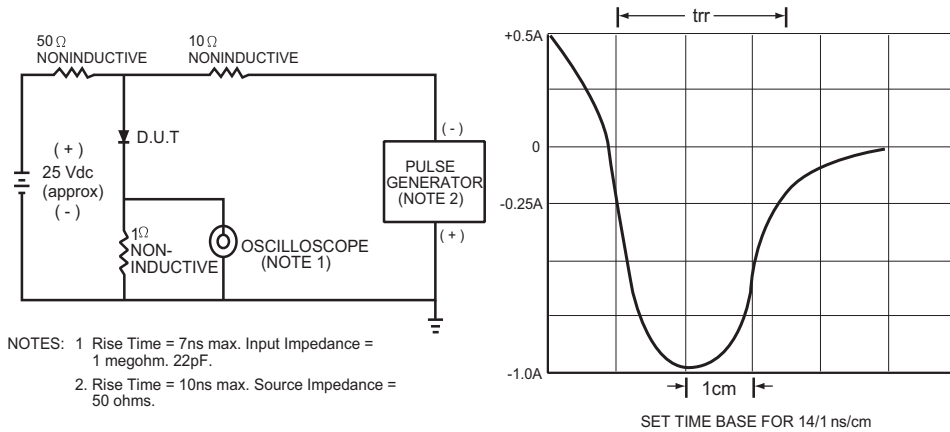

FIG.1 TEST CIRCUIT DIAGRAM AND REVERSE RECOVERY TIME CHARACTERISTIC

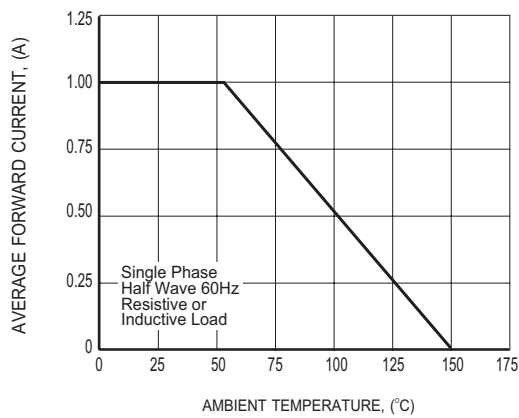

FIG.2 TYPICAL FORWARD CURRENT DERATING CURVE

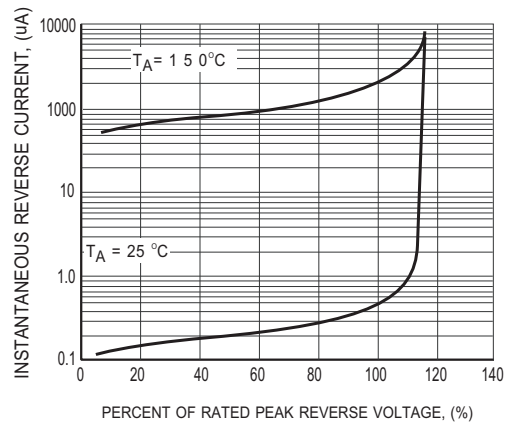

FIG.3 MAXIMUM REVERSE CHARACTERISTICS

RATING AND CHARACTERISTICS CURVES (ES1AV THRU ES1JV)

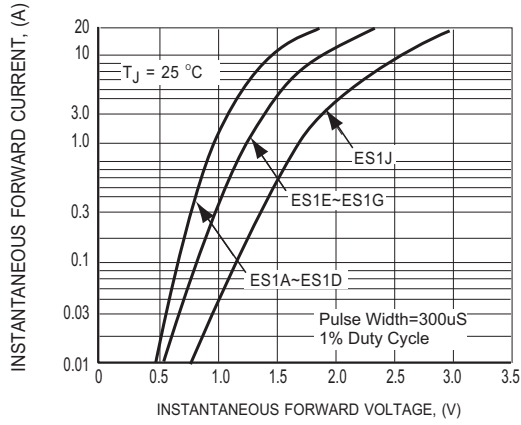

FIG.4 MAXIMUM INSTANTANEOUS FORWARD CHARACTERISTICS

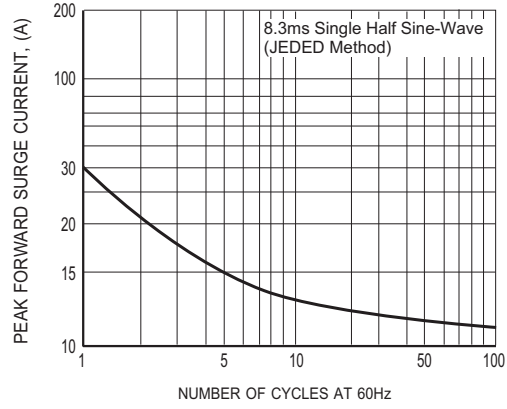

FIG.5 MAXIMUM NON-REPETITIVE FORWARD SURGE CURRENT

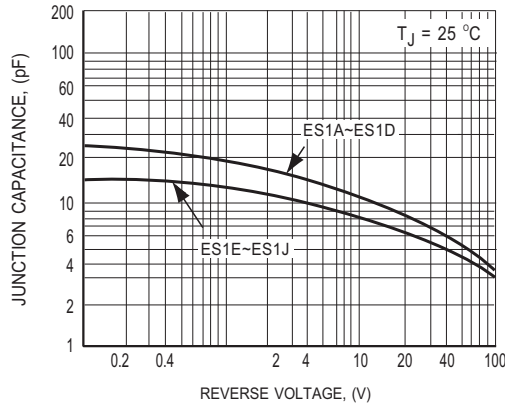
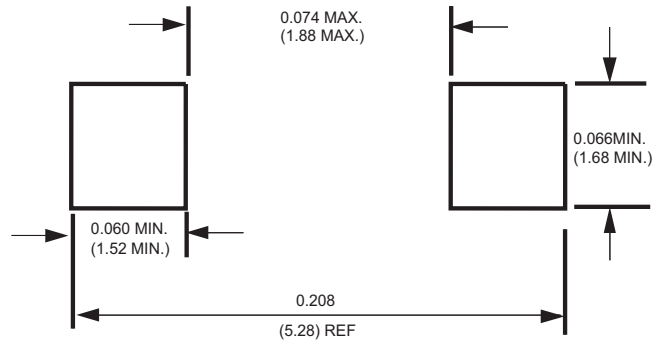

FIG.6 TYPICAL JUNCTION CAPACITANCE

Mounting Pad Layout



Dimensions in inches and (millimeters)



Attachment information about ES1XV

1. Internal Circuit



2. Marking on the body

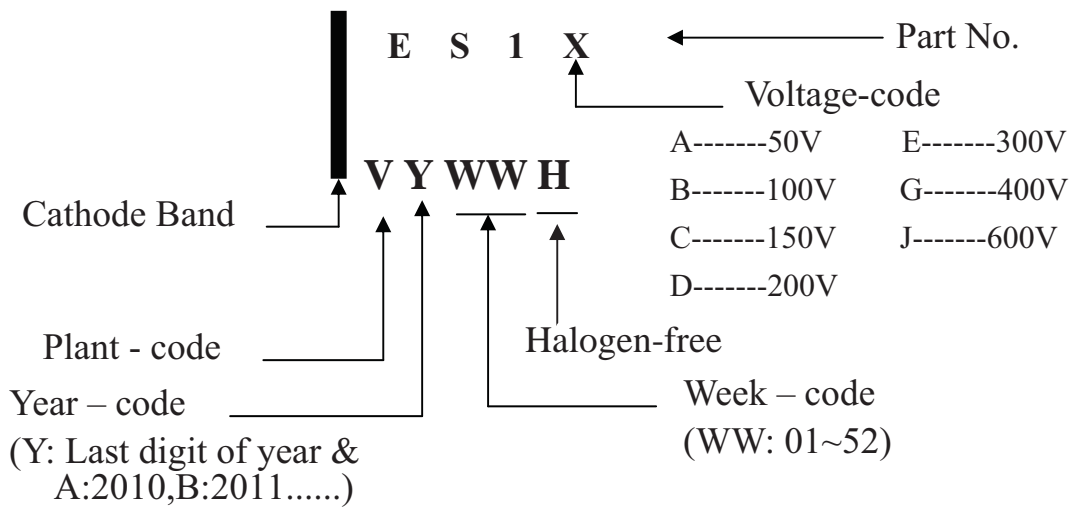



Attachment information about ES1XV

3. Items marked on the reel box and carton

3.1 On the reel (for -T & -W)

CUSTOMER

TYPE

QUANTITY

LOT NO.

Q.A.

REMARK

3.2 On the box (for -T & -W)

TYPE

QUANTITY

LOT NO.

Q.A.

3.3 On the carton

CUSTOMER

TYPE

QUANTITY

LOT NO.

REMARK

PACKAGING OF DIODE AND BRIDGE RECTIFIERS

REEL PACK

PACKAGE	PACKING CODE	EA PER REEL	EA PER INNER BOX	COMPONENT SPACE (mm)	TAPE SPACE (mm)	REEL DIA (mm)	CARTON SIZE (mm)	EA PER CARTON	GROSS WEIGHT(Kg)
SMA	-W	7,500	15,000	---	---	330	360*355*360	120,000	15.2

PACKAGE	PACKING CODE	EA PER REEL	EA PER INNER BOX	COMPONENT SPACE (mm)	TAPE SPACE (mm)	REEL DIA (mm)	CARTON SIZE (mm)	EA PER CARTON	GROSS WEIGHT(Kg)
SMA	-T	2,000	8,000	---	---	178	390*205*310	64,000	7.8

DISCLAIMER NOTICE

Rectron Inc reserves the right to make changes without notice to any product specification herein, to make corrections, modifications, enhancements or other changes. Rectron Inc or anyone on its behalf assumes no responsibility or liability for any errors or inaccuracies. Data sheet specifications and its information contained are intended to provide a product description only. "Typical" parameters which may be included on RECTRON data sheets and/ or specifications can and do vary in different applications and actual performance may vary over time. Rectron Inc does not assume any liability arising out of the application or use of any product or circuit.

Rectron products are not designed, intended or authorized for use in medical, life-saving implant or other applications intended for life-sustaining or other related applications where a failure or malfunction of component or circuitry may directly or indirectly cause injury or threaten a life without expressed written approval of Rectron Inc. Customers using or selling Rectron components for use in such applications do so at their own risk and shall agree to fully indemnify Rectron Inc and its subsidiaries harmless against all claims, damages and expenditures.