



PBS-AB016SGESSAMA0Z

PBS

PRESSURE SENSORS

SICK
Sensor Intelligence.



Illustration may differ



Ordering information

| Type | Part no. |
|---------------------|----------|
| PBS-AB016SGESSAMA0Z | 6044499 |

Other models and accessories → www.sick.com/PBS

Detailed technical data

Features

| | |
|------------------------------|--------------------|
| Medium | Liquid, gaseous |
| Pressure type | Absolute pressure |
| Measuring range | 0 bar ... 16 bar |
| Process temperature | -20 °C ... +85 °C |
| Zero point adjustment | Max. + 3 % of span |
| Output signal | 2 x PNP |
| Rotatable housing | |
| Display | |

Performance

| | |
|---|--|
| Non-linearity | ≤ ± 0.5 %, of span (Best Fit Straight Line, BFSL) according to IEC 61298-2 |
| Accuracy | ≤ ± 1 % of the span Including non-linearity, hysteresis, zero point and full scale error (corresponds to error of measurement as per IEC 61298-2) |
| Setting accuracy of switching outputs | ≤ ± 0.5 % of span |
| Response time | 3 ms |
| Long-term drift/one-year stability | ≤ 0.2 % of the span according to IEC 61298-2 |
| Temperature coefficient in rated temperature range | Mean TC of zero point: ≤ 0.2% of span / 10 K, Mean TC of span ≤ 0.2 % of span / 10 K |
| Rated temperature range | 0 °C ... +80 °C |
| Service life | Minimum 100 Mio. life cycles |

Mechanics/electronics

| | |
|------------------------------------|---|
| Process connection | G ½ B according to EN 837 |
| Wetted parts | Pressure connection: stainless steel 316L Pressure sensor: stainless steel 316L (for measurement ranges from 0 bar ... 10 bar rel stainless steel 13-8 PH) |
| Internal transmission fluid | Silicone oil (only with pressure ranges < 0 bar ... 10 bar and ≤ 0 bar abs ... 25 bar abs) |
| Pressure port | Standard |

| | |
|----------------------------------|--|
| Housing material | Lower body: stainless steel 304, Plastic head: PC + ABS, Buttons: TPE-E, Display window: PC |
| Electrical connection | Round connector M12 x 1, 4-pin, IP 67 |
| Supply voltage | |
| Power consumption | |
| Total current consumption | Max. 350 mA / 570 mA (incl. switching current) |
| Electrical safety | |
| Insolation voltage | 500 V DC |
| CE-conformity | Pressure equipment directive: This instrument is a pressure accessory as defined by the directive 97/23/EC, EMC directive: 2004/108/EC, EN 61326-2-3 |
| Weight sensor | Approx. 200 g |
| Seal | Stainless steel |
| Enclosure rating | IP 67 |
| Protection class III | ✓ |

Ambient data

| | |
|----------------------------|-------------------|
| Ambient temperature | -20 °C ... +80 °C |
| Storage temperature | -20 °C ... +80 °C |
| Relative humidity | ≤ 90 % |
| Shock load | |
| Vibration load | |

Classifications

| | |
|-----------------------|----------|
| ECl@ss 5.0 | 27371814 |
| ECl@ss 5.1.4 | 27371814 |
| ECl@ss 6.0 | 27371814 |
| ECl@ss 6.2 | 27371814 |
| ECl@ss 7.0 | 27371814 |
| ECl@ss 8.0 | 27371814 |
| ECl@ss 8.1 | 27371814 |
| ECl@ss 9.0 | 27371814 |
| ETIM 5.0 | EC000243 |
| ETIM 6.0 | EC000243 |
| UNSPSC 16.0901 | 41112409 |

Dimensional drawing (Dimensions in mm (inch))

G ½ B according to EN 837

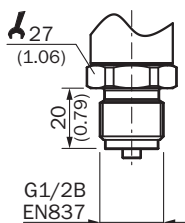

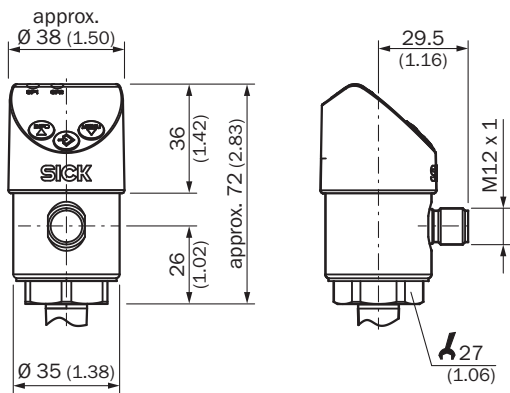



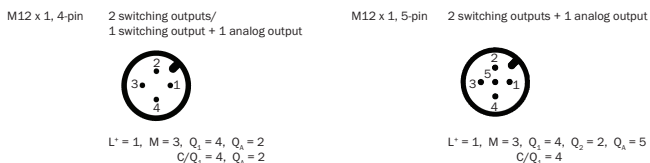

Connection type



- ① L⁺: Positive supply connection
- ② M: Negative supply connection
- ③ Q₁: Switching output 1
- ④ C/Q₁: With IO-Link: Communication/ switching output 1
- ⑤ Q₂: Switching output 2
- ⑥ Q_A: Analog output

Recommended accessories

Other models and accessories → www.sick.com/PBS

| | Brief description | Type | Part no. |
|---|--|--------------------|----------|
| Mounting brackets and mounting plates | | | |
|  | Mounting bracket for simple and stable wall mounting of pressure sensors with 27 mm hexagon, Aluminum | BEF-FL-ALUPBS-HLDR | 5322501 |
| Plug connectors and cables | | | |
|  | Head A: female connector, M12, 4-pin, straight Head B: cable Cable: PVC, unshielded, 2 m | DOL-1204-G02M | 6009382 |
|  | Head A: female connector, M12, 4-pin, straight Head B: cable Cable: drag chain use, PUR, halogen-free, unshielded, 2 m | DOL-1204-G02MC | 6025900 |
|  | Head A: female connector, M12, 4-pin, straight Head B: cable Cable: PVC, unshielded, 5 m | DOL-1204-G05M | 6009866 |

| | Brief description | Type | Part no. |
|---|---|----------------|----------|
|  | Head A: female connector, M12, 4-pin, straight Head B: cable Cable: drag chain use, PUR, halogen-free, unshielded, 5 m | DOL-1204-G05MC | 6025901 |
|  | Head A: female connector, M12, 4-pin, straight Head B: cable Cable: PVC, unshielded, 10 m | DOL-1204-G10M | 6010543 |
|  | Head A: female connector, M12, 4-pin, straight Head B: cable Cable: drag chain use, PUR, halogen-free, unshielded, 10 m | DOL-1204-G10MC | 6025902 |
|  | Head A: female connector, M12, 4-pin, straight Head B: cable Cable: PVC, unshielded, 15 m | DOL-1204-G15M | 6010753 |
|  | Head A: female connector, M12, 4-pin, straight Head B: cable Cable: PVC, unshielded, 20 m | DOL-1204-G20M | 6034401 |
|  | Head A: female connector, M12, 4-pin, angled Head B: cable Cable: PVC, unshielded, 2 m | DOL-1204-W02M | 6009383 |
|  | Head A: female connector, M12, 4-pin, angled Head B: cable Cable: drag chain use, PUR, halogen-free, unshielded, 2 m | DOL-1204-W02MC | 6025903 |
|  | Head A: female connector, M12, 4-pin, angled Head B: cable Cable: PVC, unshielded, 5 m | DOL-1204-W05M | 6009867 |
|  | Head A: female connector, M12, 4-pin, angled Head B: cable Cable: drag chain use, PUR, halogen-free, unshielded, 5 m | DOL-1204-W05MC | 6025904 |
|  | Head A: female connector, M12, 4-pin, angled Head B: cable Cable: drag chain use, Welding spark resistant, PUR, halogen-free, unshielded, 5 m | DOL-1204-W05MD | 6020399 |
|  | Head A: female connector, M12, 4-pin, angled Head B: cable Cable: PVC, unshielded, 10 m | DOL-1204-W10M | 6010541 |
|  | Head A: female connector, M12, 4-pin, angled Head B: cable Cable: drag chain use, PUR, halogen-free, unshielded, 10 m | DOL-1204-W10MC | 6025905 |
|  | Head A: female connector, M12, 4-pin, angled Head B: cable Cable: PVC, unshielded, 15 m | DOL-1204-W15M | 6036474 |
|  | Head A: female connector, M12, 4-pin, angled Head B: cable Cable: PVC, unshielded, 20 m | DOL-1204-W20M | 6033559 |

SICK AT A GLANCE

SICK is one of the leading manufacturers of intelligent sensors and sensor solutions for industrial applications. A unique range of products and services creates the perfect basis for controlling processes securely and efficiently, protecting individuals from accidents and preventing damage to the environment.

We have extensive experience in a wide range of industries and understand their processes and requirements. With intelligent sensors, we can deliver exactly what our customers need. In application centers in Europe, Asia and North America, system solutions are tested and optimized in accordance with customer specifications. All this makes us a reliable supplier and development partner.

Comprehensive services complete our offering: SICK LifeTime Services provide support throughout the machine life cycle and ensure safety and productivity.

For us, that is “Sensor Intelligence.”

WORLDWIDE PRESENCE:

Contacts and other locations –www.sick.com