

Precision Low Power FGA™ Voltage References

The ISL60002 FGA™ voltage references are very high precision analog voltage references fabricated in Intersil's proprietary Floating Gate Analog technology and feature low supply voltage operation at ultra-low 350nA operating current.

Additionally, the ISL60002 family features guaranteed initial accuracy as low as ±1.0mV and 20ppm/°C temperature coefficient. The initial accuracy and temperature stability performance of the ISL60002 family, plus the low supply voltage and 350nA power consumption, eliminates the need to compromise thermal stability for reduced power consumption making it an ideal companion to high resolution, low power data conversion systems.

Pinout

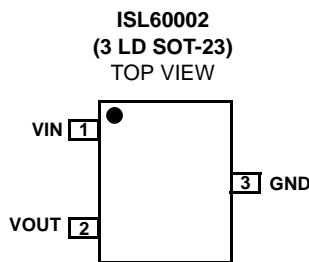

Pin Descriptions

| PIN NUMBER | PIN NAME | DESCRIPTION |
|------------|----------|--------------------------|
| 1 | VIN | Power Supply Input |
| 2 | VOUT | Voltage Reference Output |
| 3 | GND | Ground |

Features

- Reference Voltages . . . 1.024V, 1.2V, 1.25V, 1.8V, 2.048V, 2.5V, 3.0V and 3.3V
- Absolute Initial Accuracy Options. ±1.0mV, ±2.5mV and ±5.0mV
- Supply Voltage Range
 - ISL60002-10, -11, -12, -18, -20, -25 2.7V to 5.5V
 - ISL60002-30 3.2V to 5.5V
 - ISL60002-33 3.5V to 5.5V
- Ultra-Low Supply Current. 350nA typ
- Low 20ppm/°C Temperature Coefficient
- I_{SOURCE} and I_{SINK} = 7mA
- I_{SOURCE} and I_{SINK} = 20mA for ISL60002-33 only
- ESD Protection. 5500V (Human Body Model)
- Standard 3 Ld SOT-23 Packaging
- Operating Temperature Range
 - ISL60002-10, -11, -12, -18, -20, -25, -30 -40°C to +85°C
 - ISL60002-33 -40°C to +105°C
- Pb-Free Available (RoHS Compliant)

Applications

- High Resolution A/Ds and D/As
- Digital Meters
- Bar Code Scanners
- Mobile Communications
- PDA's and Notebooks
- Medical Systems

Table of Contents

Pinout 1

Pin Descriptions 1

Typical Application..... 3

Ordering Information 3

Absolute Maximum Ratings..... 5

Electrical Specifications

 ISL60002-10, $V_{OUT} = 1.024V$ 5

 ISL60002-11, $V_{OUT} = 1.200V$ 5

 ISL60002-12, $V_{OUT} = 1.250V$ 5

 ISL60002-18, $V_{OUT} = 1.800V$ 6

 ISL60002-20, $V_{OUT} = 2.048V$ 6

 ISL60002-25, $V_{OUT} = 2.500V$ 6

 ISL60002-30, $V_{OUT} = 3.000V$ 6

 ISL60002-33, $V_{OUT} = 3.300V$ 7

Common Electrical Specifications 7

 ISL60002 -10, -11, -12, -18, -20, and -25 7

Typical Performance Characteristic Curves

 ISL60002, $V_{OUT} = 1.024V$ 8

 ISL60002, $V_{OUT} = 1.20V$ 11

 ISL60002, $V_{OUT} = 1.25V$ 14

 ISL60002, $V_{OUT} = 1.8V$ 17

 ISL60002, $V_{OUT} = 2.048V$ 20

 ISL60002, $V_{OUT} = 2.50V$ 23

 ISL60002, $V_{OUT} = 3.0V$ 26

 ISL60002, $V_{OUT} = 3.3V$ 29

High Current Application 32

Applications Information..... 32

Typical Application Circuits..... 34

Typical Application

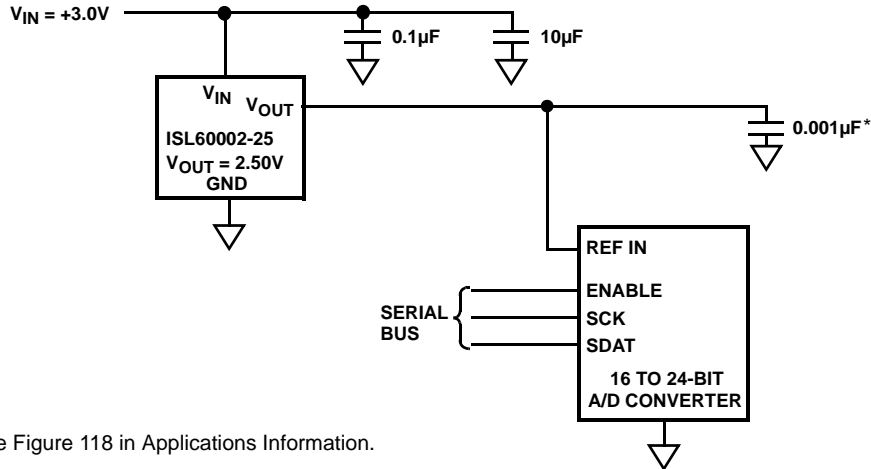

*Also see Figure 118 in Applications Information.

Ordering Information

| PART NUMBER | PART MARKING (Bottom) | V_{OUT} (V) | GRADE | TEMP. RANGE (°C) | PACKAGE Tape & Reel | PKG. DWG. # |
|----------------------------|-----------------------|---------------|------------------|------------------|-----------------------|-------------|
| ISL60002BIH310Z-TK* (Note) | DFB | 1.024 | ±1.0mV, 20ppm/°C | -40 to +85 | 3 Ld SOT-23 (Pb-free) | P3.064 |
| ISL60002CIH310Z-TK* (Note) | DFC | 1.024 | ±2.5mV, 20ppm/°C | -40 to +85 | 3 Ld SOT-23 (Pb-free) | P3.064 |
| ISL60002DIH310Z-TK* (Note) | DFD | 1.024 | ±5.0mV, 20ppm/°C | -40 to +85 | 3 Ld SOT-23 (Pb-free) | P3.064 |
| ISL60002BIH311Z-TK* (Note) | APM | 1.200 | ±1.0mV, 20ppm/°C | -40 to +85 | 3 Ld SOT-23 (Pb-free) | P3.064 |
| ISL60002CIH311Z-TK* (Note) | AOR | 1.200 | ±2.5mV, 20ppm/°C | -40 to +85 | 3 Ld SOT-23 (Pb-free) | P3.064 |
| ISL60002DIH311Z-TK* (Note) | AOY | 1.200 | ±5.0mV, 20ppm/°C | -40 to +85 | 3 Ld SOT-23 (Pb-free) | P3.064 |
| ISL60002BIH312Z-TK* | AIL | 1.250 | ±1.0mV, 20ppm/°C | -40 to +85 | 3 Ld SOT-23 | P3.064 |
| ISL60002BIH312Z-TK* (Note) | AOM | 1.250 | ±1.0mV, 20ppm/°C | -40 to +85 | 3 Ld SOT-23 (Pb-free) | P3.064 |
| ISL60002CIH312Z-TK* | AIN | 1.250 | ±2.5mV, 20ppm/°C | -40 to +85 | 3 Ld SOT-23 | P3.064 |
| ISL60002CIH312Z-TK* (Note) | AOS | 1.250 | ±2.5mV, 20ppm/°C | -40 to +85 | 3 Ld SOT-23 (Pb-free) | P3.064 |
| ISL60002DIH312Z-TK* | AIP | 1.250 | ±5.0mV, 20ppm/°C | -40 to +85 | 3 Ld SOT-23 | P3.064 |
| ISL60002DIH312Z-TK* (Note) | APA | 1.250 | ±5.0mV, 20ppm/°C | -40 to +85 | 3 Ld SOT-23 (Pb-free) | P3.064 |
| ISL60002BIH318Z-TK* (Note) | DEO | 1.800 | ±1.0mV, 20ppm/°C | -40 to +85 | 3 Ld SOT-23 (Pb-free) | P3.064 |
| ISL60002CIH318Z-TK* (Note) | DEP | 1.800 | ±2.5mV, 20ppm/°C | -40 to +85 | 3 Ld SOT-23 (Pb-free) | P3.064 |
| ISL60002DIH318Z-TK* (Note) | DEQ | 1.800 | ±5.0mV, 20ppm/°C | -40 to +85 | 3 Ld SOT-23 (Pb-free) | P3.064 |
| ISL60002BIH320Z-TK* (Note) | DEY | 2.048 | ±1.0mV, 20ppm/°C | -40 to +85 | 3 Ld SOT-23 (Pb-free) | P3.064 |
| ISL60002CIH320Z-TK* (Note) | DEZ | 2.048 | ±2.5mV, 20ppm/°C | -40 to +85 | 3 Ld SOT-23 (Pb-free) | P3.064 |
| ISL60002DIH320Z-TK* (Note) | DFA | 2.048 | ±5.0mV, 20ppm/°C | -40 to +85 | 3 Ld SOT-23 (Pb-free) | P3.064 |
| ISL60002BIH325Z-TK* | AIK | 2.500 | ±1.0mV, 20ppm/°C | -40 to +85 | 3 Ld SOT-23 | P3.064 |
| ISL60002BIH325Z-TK* (Note) | AON | 2.500 | ±1.0mV, 20ppm/°C | -40 to +85 | 3 Ld SOT-23 (Pb-free) | P3.064 |
| ISL60002CIH325Z-TK* | AIM | 2.500 | ±2.5mV, 20ppm/°C | -40 to +85 | 3 Ld SOT-23 | P3.064 |
| ISL60002CIH325Z-TK* (Note) | AOT | 2.500 | ±2.5mV, 20ppm/°C | -40 to +85 | 3 Ld SOT-23 (Pb-free) | P3.064 |
| ISL60002DIH325Z-TK* | AIO | 2.500 | ±5.0mV, 20ppm/°C | -40 to +85 | 3 Ld SOT-23 | P3.064 |
| ISL60002DIH325Z-TK* (Note) | APB | 2.500 | ±5.0mV, 20ppm/°C | -40 to +85 | 3 Ld SOT-23 (Pb-free) | P3.064 |

Ordering Information (Continued)

| PART NUMBER | PART MARKING (Bottom) | V _{OUT} (V) | GRADE | TEMP. RANGE (°C) | PACKAGE Tape & Reel | PKG. DWG. # |
|----------------------------|-----------------------|----------------------|------------------|------------------|-----------------------|-------------|
| ISL60002BIH330Z-TK* (Note) | DFI | 3.000 | ±1.0mV, 20ppm/°C | -40 to +85 | 3 Ld SOT-23 (Pb-free) | P3.064 |
| ISL60002CIH330Z-TK* (Note) | DFJ | 3.000 | ±2.5mV, 20ppm/°C | -40 to +85 | 3 Ld SOT-23 (Pb-free) | P3.064 |
| ISL60002DIH330Z-TK* (Note) | DFH | 3.000 | ±5.0mV, 20ppm/°C | -40 to +85 | 3 Ld SOT-23 (Pb-free) | P3.064 |
| ISL60002BAH333Z-TK* (Note) | AOP | 3.300 | ±1.0mV, 20ppm/°C | -40 to +105 | 3 Ld SOT-23 (Pb-free) | P3.064 |
| ISL60002CAH333Z-TK* (Note) | AOU | 3.300 | ±2.5mV, 20ppm/°C | -40 to +105 | 3 Ld SOT-23 (Pb-free) | P3.064 |
| ISL60002DAH333Z-TK* (Note) | APC | 3.300 | ±5.0mV, 20ppm/°C | -40 to +105 | 3 Ld SOT-23 (Pb-free) | P3.064 |

*Please refer to TB347 for details on reel specifications.

NOTE: These Intersil Pb-free plastic packaged products employ special Pb-free material sets; molding compounds/die attach materials and 100% matte tin plate PLUS ANNEAL - e3 termination finish, which is RoHS compliant and compatible with both SnPb and Pb-free soldering operations. Intersil Pb-free products are MSL classified at Pb-free peak reflow temperatures that meet or exceed the Pb-free requirements of IPC/JEDEC J STD-020.

Absolute Maximum Ratings

| | |
|------------------------------------|--|
| Max Voltage V_{IN} to GND | -0.5V to +6.5V |
| Max Voltage V_{OUT} to GND (10s) | -0.5V to $+V_{OUT} + 1V$ |
| Voltage on "DNC" pins | No connections permitted to these pins |
| ESD Ratings | |
| Human Body Model | 5500V |
| Machine Model | 550V |
| Charged Device Model | 2kV |

Thermal Information

| | |
|---|---------------------------|
| Thermal Resistance (Typical, Note 1) | θ_{JA} (°C/W) |
| 3 Ld SOT-23 | 202.70 |
| Continuous Power Dissipation | $T_A = +85^\circ\text{C}$ |
| Maximum Junction Temperature (Plastic Package) | +107°C |
| Storage Temperature Range | -65°C to +150°C |
| Pb-free reflow profile | see link below |
| http://www.intersil.com/pbfree/Pb-FreeReflow.asp | |

Recommended Operating Conditions

| | |
|----------------------------------|-----------------|
| Temperature Range (Industrial) | -40°C to +85°C |
| Temperature Range (3.3V version) | -40°C to +105°C |

CAUTION: Do not operate at or near the maximum ratings listed for extended periods of time. Exposure to such conditions may adversely impact product reliability and result in failures not covered by warranty.

NOTE:

- θ_{JA} is measured with the component mounted on a high effective thermal conductivity test board in free air. See Tech Brief TB379 for details.

Electrical Specifications ISL60002-10, $V_{OUT} = 1.024V$ (Additional specifications on page 7, "Common Electrical Specifications")
 Operating Conditions: $V_{IN} = 3.0V$, $I_{OUT} = 0mA$, $C_{OUT} = 0.001\mu F$,
 $T_A = -40$ to $+85^\circ\text{C}$, unless otherwise specified.

| SYMBOL | PARAMETER | CONDITIONS | MIN | TYP | MAX | UNITS |
|-----------|---------------------|---------------------------|------|-------|------|-------|
| V_{OUT} | Output Voltage | | | 1.024 | | V |
| V_{OA} | V_{OUT} Accuracy | $T_A = +25^\circ\text{C}$ | | | | |
| | | ISL60002B10 | -1.0 | | +1.0 | mV |
| | | ISL60002C10 | -2.5 | | +2.5 | mV |
| | | ISL60002D10 | -5.0 | | +5.0 | mV |
| V_{IN} | Input Voltage Range | | 2.7 | | 5.5 | V |

Electrical Specifications ISL60002-11, $V_{OUT} = 1.200V$ (Additional specifications on page 7, "Common Electrical Specifications")
 Operating Conditions: $V_{IN} = 3.0V$, $I_{OUT} = 0mA$, $C_{OUT} = 0.001\mu F$, $T_A = -40$ to $+85^\circ\text{C}$, unless otherwise specified.

| SYMBOL | PARAMETER | CONDITIONS | MIN | TYP | MAX | UNITS |
|-----------|---------------------|---------------------------|------|-------|------|-------|
| V_{OUT} | Output Voltage | | | 1.200 | | V |
| V_{OA} | V_{OUT} Accuracy | $T_A = +25^\circ\text{C}$ | | | | |
| | | ISL60002B11 | -1.0 | | +1.0 | mV |
| | | ISL60002C11 | -2.5 | | +2.5 | mV |
| | | ISL60002D11 | -5.0 | | +5.0 | mV |
| V_{IN} | Input Voltage Range | | 2.7 | | 5.5 | V |

Electrical Specifications ISL60002-12, $V_{OUT} = 1.250V$ (Additional specifications on page 7, "Common Electrical Specifications")
 Operating Conditions: $V_{IN} = 3.0V$, $I_{OUT} = 0mA$, $C_{OUT} = 0.001\mu F$,
 $T_A = -40$ to $+85^\circ\text{C}$, unless otherwise specified.

| SYMBOL | PARAMETER | CONDITIONS | MIN | TYP | MAX | UNITS |
|-----------|---------------------|---------------------------|------|-------|------|-------|
| V_{OUT} | Output Voltage | | | 1.250 | | V |
| V_{OA} | V_{OUT} Accuracy | $T_A = +25^\circ\text{C}$ | | | | |
| | | ISL60002B12 | -1.0 | | +1.0 | mV |
| | | ISL60002C12 | -2.5 | | +2.5 | mV |
| | | ISL60002D12 | -5.0 | | +5.0 | mV |
| V_{IN} | Input Voltage Range | | 2.7 | | 5.5 | V |

ISL60002

Electrical Specifications ISL60002-18, $V_{OUT} = 1.800V$ (Additional specifications on page 7, “Common Electrical Specifications”)
 Operating Conditions: $V_{IN} = 3.0V$, $I_{OUT} = 0mA$, $C_{OUT} = 0.001\mu F$, $T_A = -40$ to $+85^\circ C$, unless otherwise specified.

| SYMBOL | PARAMETER | CONDITIONS | MIN | TYP | MAX | UNITS |
|-----------|---------------------|---------------------|------|-------|------|-------|
| V_{OUT} | Output Voltage | | | 1.800 | | V |
| V_{OA} | V_{OUT} Accuracy | $T_A = +25^\circ C$ | | | | |
| | | ISL60002B18 | -1.0 | | +1.0 | mV |
| | | ISL60002C18 | -2.5 | | +2.5 | mV |
| | | ISL60002D18 | -5.0 | | +5.0 | mV |
| V_{IN} | Input Voltage Range | | 2.7 | | 5.5 | V |

Electrical Specifications ISL60002-20, $V_{OUT} = 2.048V$ (Additional specifications on page 7, “Common Electrical Specifications”)
 Operating Conditions: $V_{IN} = 3.0V$, $I_{OUT} = 0mA$, $C_{OUT} = 0.001\mu F$, $T_A = -40$ to $+85^\circ C$, unless otherwise specified.

| SYMBOL | PARAMETER | CONDITIONS | MIN | TYP | MAX | UNITS |
|-----------|---------------------|---------------------|------|-------|------|-------|
| V_{OUT} | Output Voltage | | | 2.048 | | V |
| V_{OA} | V_{OUT} Accuracy | $T_A = +25^\circ C$ | | | | |
| | | ISL60002B20 | -1.0 | | +1.0 | mV |
| | | ISL60002C20 | -2.5 | | +2.5 | mV |
| | | ISL60002D20 | -5.0 | | +5.0 | mV |
| V_{IN} | Input Voltage Range | | 2.7 | | 5.5 | V |

Electrical Specifications ISL60002-25, $V_{OUT} = 2.500V$ (Additional specifications on page 7, “Common Electrical Specifications”)
 Operating Conditions: $V_{IN} = 3.0V$, $I_{OUT} = 0mA$, $C_{OUT} = 0.001\mu F$, $T_A = -40$ to $+85^\circ C$, unless otherwise specified.

| SYMBOL | PARAMETER | CONDITIONS | MIN | TYP | MAX | UNITS |
|-----------|---------------------|---------------------|------|-------|------|-------|
| V_{OUT} | Output Voltage | | | 2.500 | | V |
| V_{OA} | V_{OUT} Accuracy | $T_A = +25^\circ C$ | | | | |
| | | ISL60002B25 | -1.0 | | +1.0 | mV |
| | | ISL60002C25 | -2.5 | | +2.5 | mV |
| | | ISL60002D25 | -5.0 | | +5.0 | mV |
| V_{IN} | Input Voltage Range | | 2.7 | | 5.5 | V |

Electrical Specifications ISL60002-30, $V_{OUT} = 3.000V$ Operating Conditions: $V_{IN} = 5.0V$, $I_{OUT} = 0mA$, $C_{OUT} = 0.001\mu F$,
 $T_A = -40$ to $+85^\circ C$, unless otherwise specified.

| SYMBOL | PARAMETER | CONDITIONS | MIN | TYP | MAX | UNITS |
|---------------------------------|---|-----------------------------------|------|-------|------|-----------------|
| V_{OUT} | Output Voltage | | | 3.000 | | V |
| V_{OA} | V_{OUT} Accuracy | $T_A = +25^\circ C$ | | | | |
| | | ISL60002B30 | -1.0 | | +1.0 | mV |
| | | ISL60002C30 | -2.5 | | +2.5 | mV |
| | | ISL60002D30 | -5.0 | | +5.0 | mV |
| V_{IN} | Input Voltage Range | | 3.2 | | 5.5 | V |
| $TC V_{OUT}$ | Output Voltage Temperature Coefficient (Note 2) | | | | 20 | ppm/ $^\circ C$ |
| I_{IN} | Supply Current | | | 350 | 900 | nA |
| $\Delta V_{OUT}/\Delta V_{IN}$ | Line Regulation | $+3.2V \leq V_{IN} \leq +5.5V$ | | 80 | 250 | $\mu V/V$ |
| $\Delta V_{OUT}/\Delta I_{OUT}$ | Load Regulation | $0mA \leq I_{SOURCE} \leq 7mA$ | | 25 | 100 | $\mu V/mA$ |
| | | $-7mA \leq I_{SINK} \leq 0mA$ | | 50 | 150 | $\mu V/mA$ |
| $\Delta V_{OUT}/\Delta T_A$ | Thermal Hysteresis (Note 3) | $\Delta T_A = +125^\circ C$ | | 100 | | ppm |
| $\Delta V_{OUT}/\Delta t$ | Long Term Stability (Note 4) | $T_A = +25^\circ C$; First 1khrs | | 50 | | ppm |
| I_{SC} | Short Circuit Current (to GND) | $T_A = +25^\circ C$ | | 50 | | mA |
| V_N | Output Voltage Noise | $0.1Hz \leq f \leq 10Hz$ | | 30 | | μV_{P-P} |

ISL60002

Electrical Specifications ISL60002-33, $V_{OUT} = 3.300V$ Operating Conditions: $V_{IN} = 5.0V$, $I_{OUT} = 0mA$, $C_{OUT} = 0.001\mu F$, $T_A = -40$ to $+105^\circ C$, unless otherwise specified.

| SYMBOL | PARAMETER | CONDITIONS | MIN | TYP | MAX | UNITS |
|---------------------------------|---|---|------|-------|-----|-----------------|
| V_{OUT} | Output Voltage | | | 3.300 | | V |
| V_{OA} | V_{OUT} Accuracy | $T_A = +25^\circ C$ ISL60002B33 | -1.0 | | 1.0 | mV |
| | | ISL60002C33 | -2.5 | | 2.5 | mV |
| | | ISL60002D33 | -5.0 | | 5.0 | mV |
| TC V_{OUT} | Output Voltage Temperature Coefficient (Note 2) | | | | 20 | ppm/ $^\circ C$ |
| V_{IN} | Input Voltage Range | | 3.5 | | 5.5 | V |
| I_{IN} | Supply Current | | | 350 | 700 | nA |
| $\Delta V_{OUT}/\Delta V_{IN}$ | Line Regulation | $+3.5V \leq V_{IN} \leq +5.5V$ | | 80 | 200 | $\mu V/V$ |
| $\Delta V_{OUT}/\Delta I_{OUT}$ | Load Regulation | $0mA \leq I_{SOURCE} \leq 20mA$ $-20mA \leq I_{SINK} \leq 0mA$ | | 25 | 100 | $\mu V/mA$ |
| $\Delta V_{OUT}/\Delta T_A$ | Thermal Hysteresis (Note 3) | $\Delta T_A = +145^\circ C$ | | 100 | | ppm |
| $\Delta V_{OUT}/\Delta t$ | Long Term Stability (Note 4) | $T_A = +25^\circ C$; First 1khrs | | 50 | | ppm |
| I_{SC} | Short Circuit Current (to GND) | $T_A = +25^\circ C$ | | 50 | | mA |
| V_N | Output Voltage Noise | $0.1Hz \leq f \leq 10Hz$ | | 30 | | μV_{P-P} |

Common Electrical Specifications ISL60002 -10, -11, -12, -18, -20, and -25 Operating Conditions: $V_{IN} = 3.0V$, $I_{OUT} = 0mA$, $C_{OUT} = 0.001\mu F$, $T_A = -40$ to $+85^\circ C$, unless otherwise specified

| SYMBOL | PARAMETER | CONDITIONS | MIN | TYP | MAX | UNITS |
|---------------------------------|---|---|-----|-----|-----|-----------------|
| TC V_{OUT} | Output Voltage Temperature Coefficient (Note 2) | | | | 20 | ppm/ $^\circ C$ |
| I_{IN} | Supply Current | | | 350 | 900 | nA |
| $\Delta V_{OUT}/\Delta V_{IN}$ | Line Regulation | $+2.7V \leq V_{IN} \leq +5.5V$ | | 80 | 250 | $\mu V/V$ |
| $\Delta V_{OUT}/\Delta I_{OUT}$ | Load Regulation | $0mA \leq I_{SOURCE} \leq 7mA$ $-7mA \leq I_{SINK} \leq 0mA$ | | 25 | 100 | $\mu V/mA$ |
| $\Delta V_{OUT}/\Delta T_A$ | Thermal Hysteresis (Note 3) | $\Delta T_A = +125^\circ C$ | | 100 | | ppm |
| $\Delta V_{OUT}/\Delta t$ | Long Term Stability (Note 4) | $T_A = +25^\circ C$; First 1khrs | | 50 | | ppm |
| I_{SC} | Short Circuit Current (to GND) | $T_A = +25^\circ C$ | | 50 | | mA |
| V_N | Output Voltage Noise | $0.1Hz \leq f \leq 10Hz$ | | 30 | | μV_{P-P} |

*Short Circuit Current (to V_{CC}) for ISL60002-25 at $V_{IN} = 5.0V$ and $+25^\circ C$ is typically around 30mA. Shorting V_{OUT} to V_{CC} is not recommended due to risk of resetting the part.

NOTES:

- Over the specified temperature range. Temperature coefficient is measured by the box method whereby the change in V_{OUT} is divided by the temperature range: $(-40^\circ C$ to $+85^\circ C = +125^\circ C$, or $-40^\circ C$ to $+105^\circ C = +145^\circ C$ for the ISL60002-33).
- Thermal Hysteresis is the change in V_{OUT} measured @ $T_A = +25^\circ C$ after temperature cycling over a specified range, ΔT_A . V_{OUT} is read initially at $T_A = +25^\circ C$ for the device under test. The device is temperature cycled and a second V_{OUT} measurement is taken at $+25^\circ C$. The difference between the initial V_{OUT} reading and the second V_{OUT} reading is then expressed in ppm. For $\Delta T_A = +125^\circ C$, the device under is cycled from $+25^\circ C$ to $+85^\circ C$ to $-40^\circ C$ to $+25^\circ C$, and for $\Delta T_A = +145^\circ C$, the device under is cycled from $+25^\circ C$ to $+105^\circ C$ to $-40^\circ C$ to $+25^\circ C$
- Long term drift is logarithmic in nature and diminishes over time. Drift after the first 1000 hours will be approximately 10ppm.

Typical Performance Characteristic Curves ISL60002, $V_{OUT} = 1.024V$

$V_{IN} = 3.0V$, $I_{OUT} = 0mA$, $T_A = +25^{\circ}C$ unless otherwise specified.

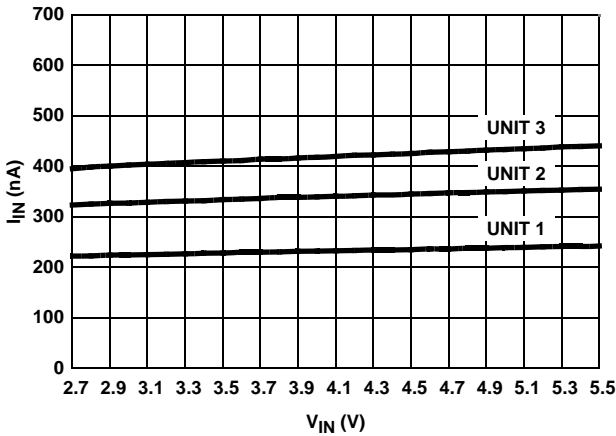

FIGURE 1. I_{IN} vs V_{IN} , 3 UNITS

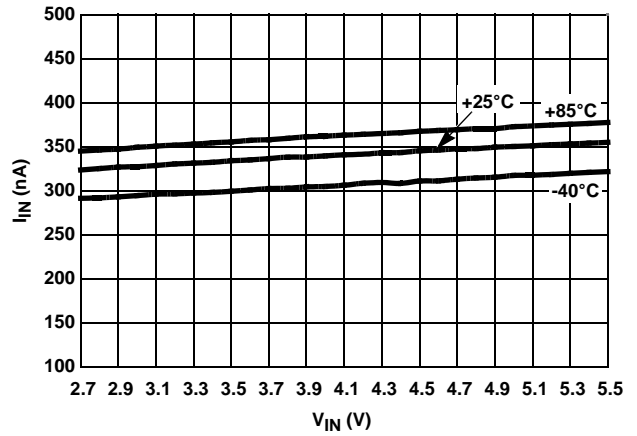

FIGURE 2. I_{IN} vs V_{IN} OVER-TEMPERATURE

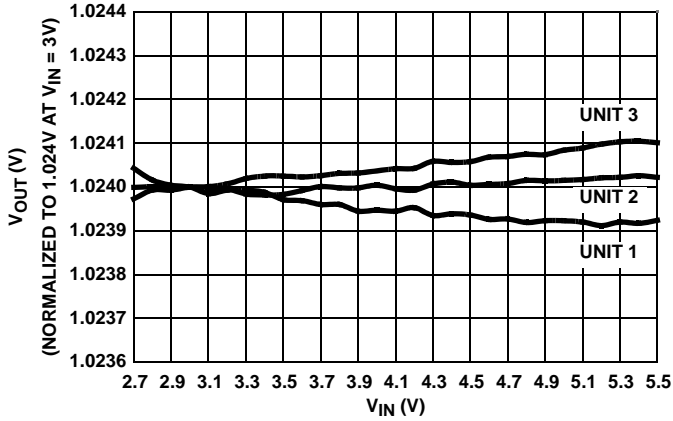

FIGURE 3. LINE REGULATION, 3 UNITS

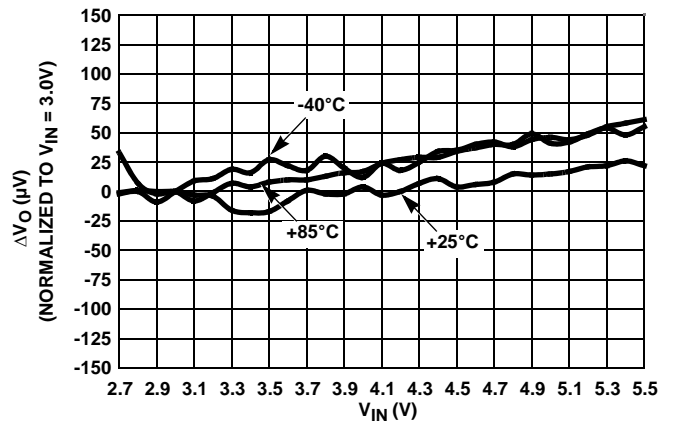

FIGURE 4. LINE REGULATION OVER-TEMPERATURE

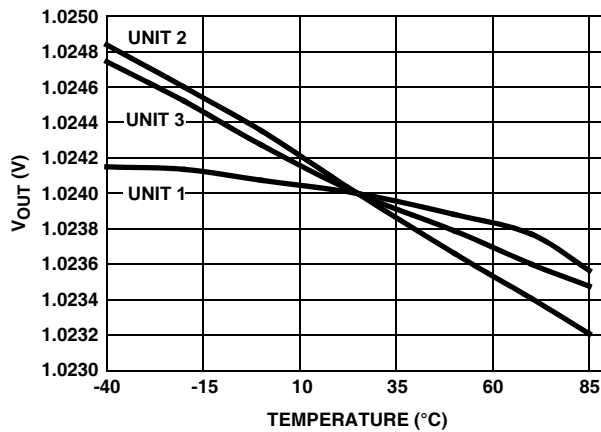

FIGURE 5. V_{OUT} vs TEMPERATURE NORMALIZED to $+25^{\circ}C$

Typical Performance Characteristic Curves ISL60002, $V_{OUT} = 1.024V$ (Continued)

$V_{IN} = 3.0V$, $I_{OUT} = 0mA$, $T_A = +25^\circ C$ unless otherwise specified.

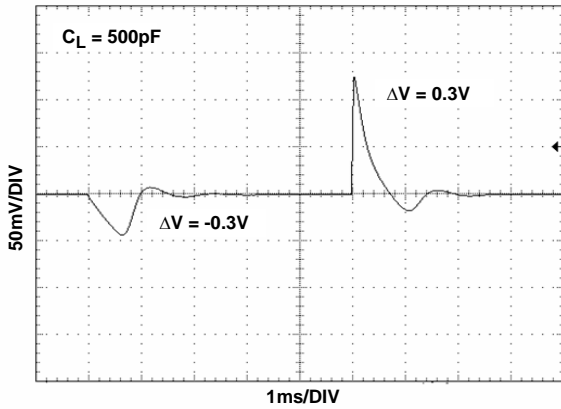

FIGURE 6. LINE TRANSIENT RESPONSE, WITH CAPACITIVE LOAD

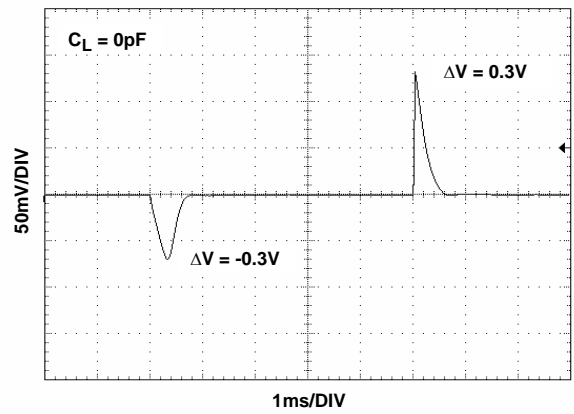

FIGURE 7. LINE TRANSIENT RESPONSE

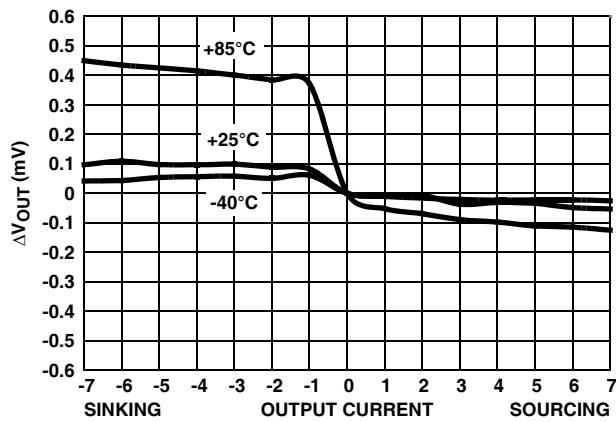

FIGURE 8. LOAD REGULATION OVER-TEMPERATURE

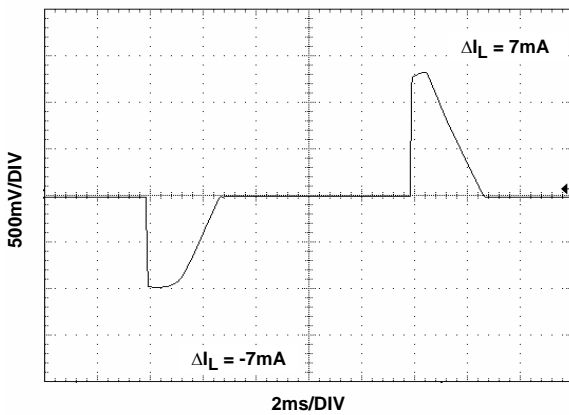

FIGURE 9. LOAD TRANSIENT RESPONSE

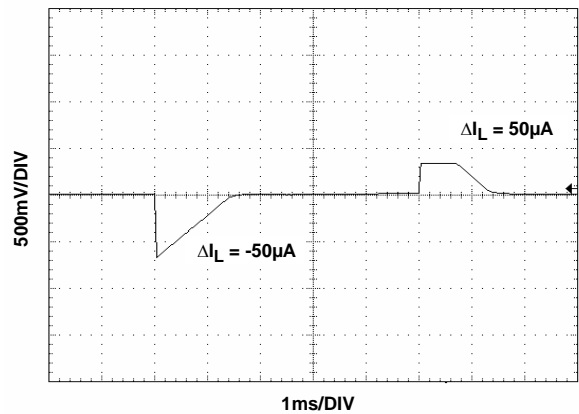

FIGURE 10. LOAD TRANSIENT RESPONSE

Typical Performance Characteristic Curves ISL60002, $V_{OUT} = 1.024V$ (Continued)

$V_{IN} = 3.0V$, $I_{OUT} = 0mA$, $T_A = +25^{\circ}C$ unless otherwise specified.

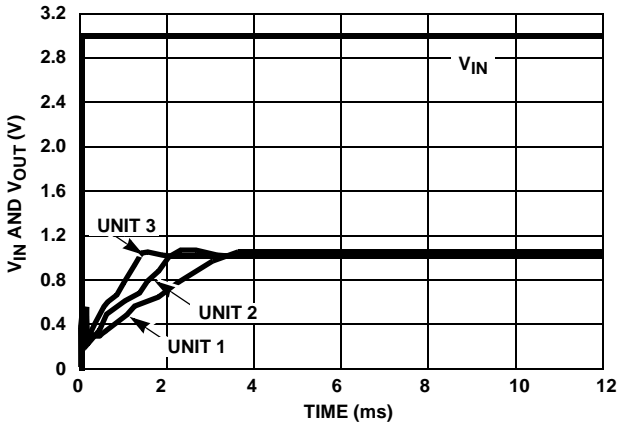

FIGURE 11. TURN-ON TIME (+25°C)

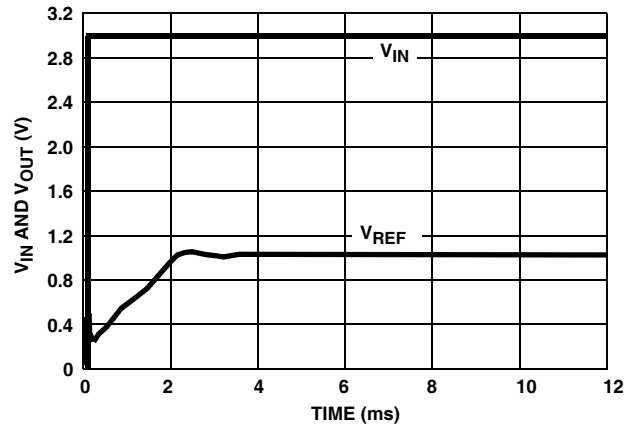

FIGURE 12. TURN-ON TIME (+25°C)

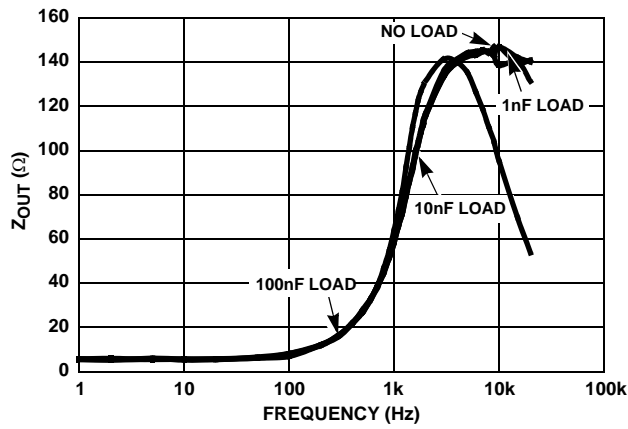

FIGURE 13. Z_{OUT} vs FREQUENCY

Typical Performance Characteristic Curves ISL60002, $V_{OUT} = 1.20V$

$V_{IN} = 3.0V$, $I_{OUT} = 0mA$, $T_A = +25^\circ C$ unless otherwise specified

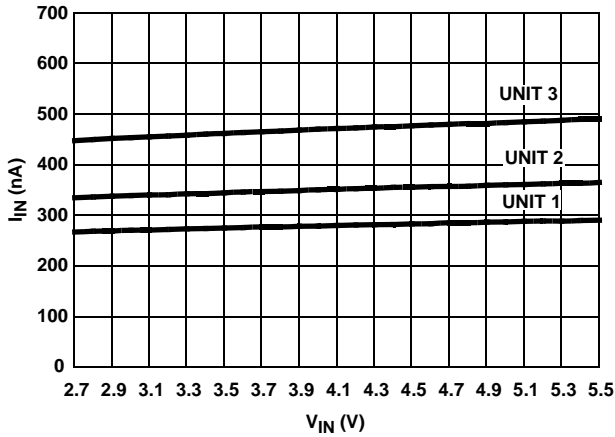

FIGURE 14. I_{IN} vs V_{IN} , 3 UNITS

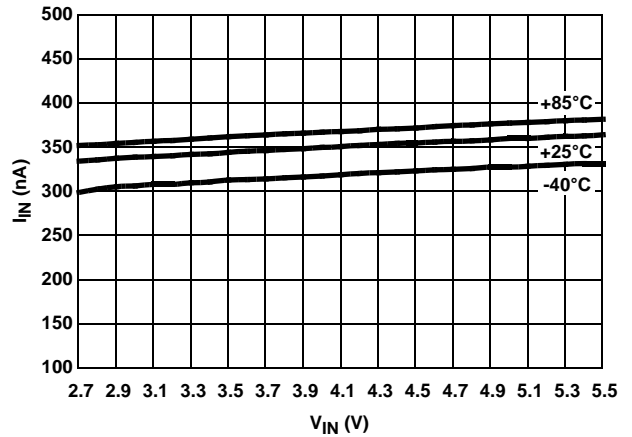

FIGURE 15. I_{IN} vs V_{IN} OVER TEMPERATURE

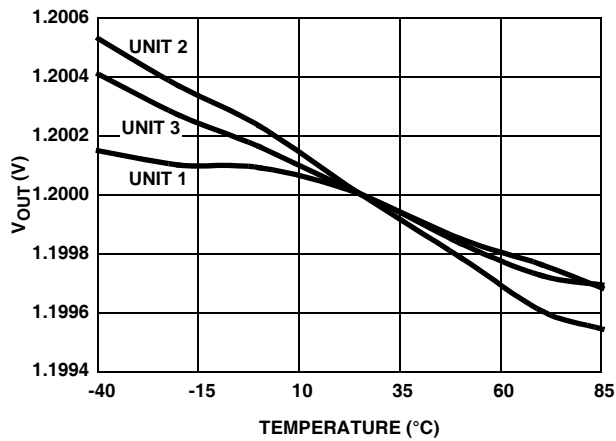

FIGURE 16. V_{OUT} vs TEMPERATURE NORMALIZED TO $+25^\circ C$

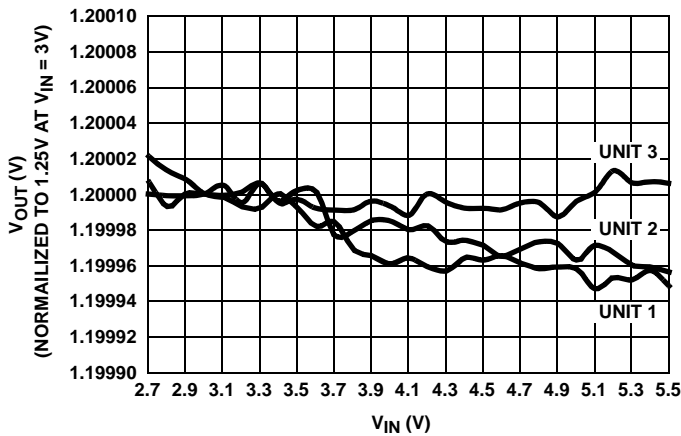

FIGURE 17. LINE REGULATION, 3 UNITS

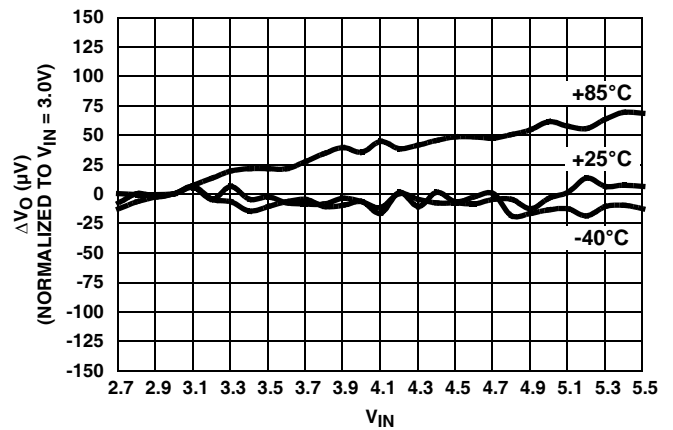

FIGURE 18. LINE REGULATION OVER-TEMPERATURE

Typical Performance Characteristic Curves ISL60002, $V_{OUT} = 1.20V$ (Continued)

$V_{IN} = 3.0V$, $I_{OUT} = 0mA$, $T_A = +25^\circ C$ unless otherwise specified

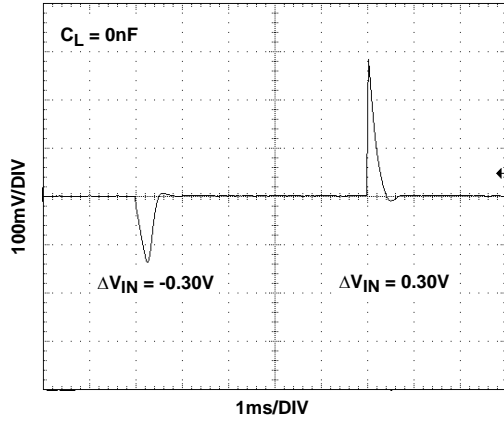

FIGURE 19. LINE TRANSIENT RESPONSE

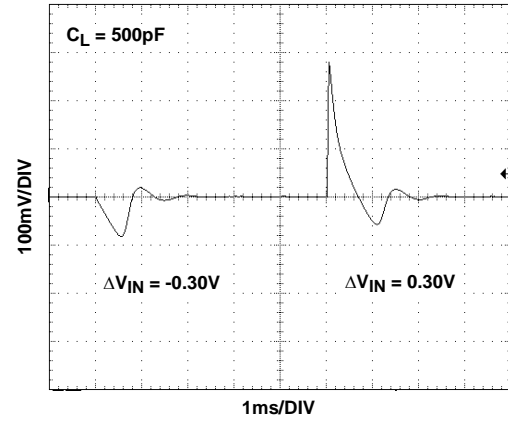

FIGURE 20. LINE TRANSIENT RESPONSE WITH CAPACITIVE LOAD

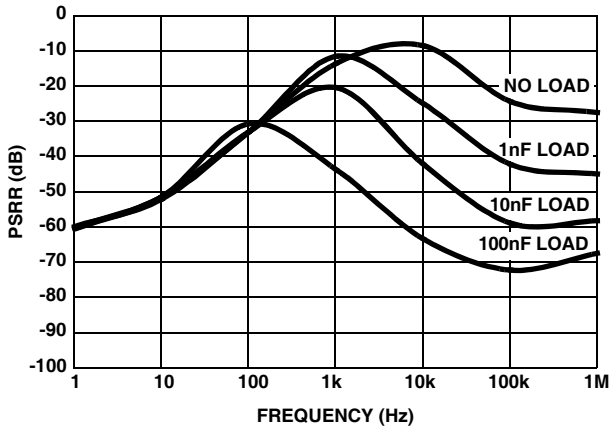

FIGURE 21. PSRR vs CAPACITIVE LOAD

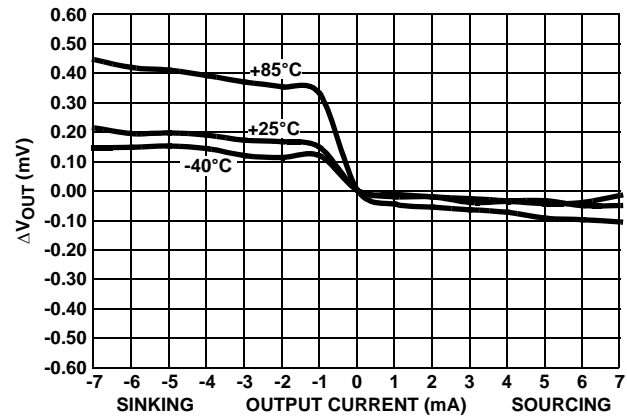

FIGURE 22. LOAD REGULATION OVER-TEMPERATURE

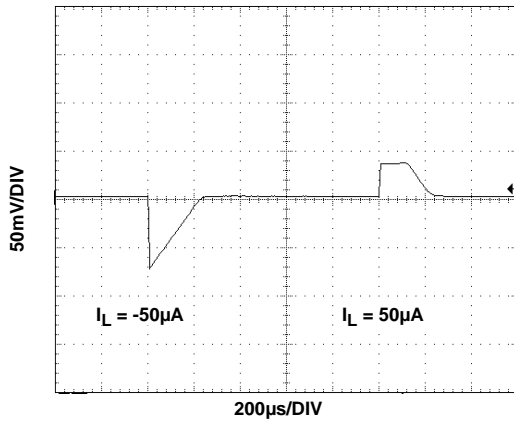

FIGURE 23. LOAD TRANSIENT RESPONSE

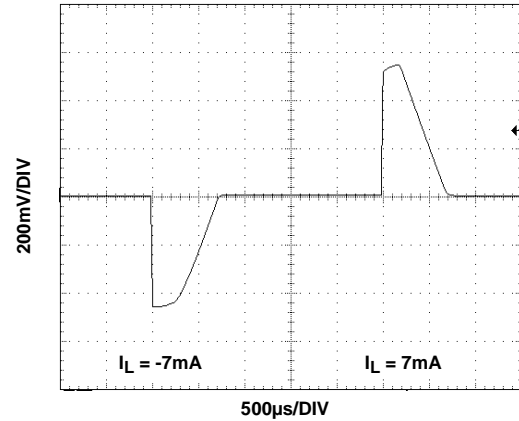

FIGURE 24. LOAD TRANSIENT RESPONSE

Typical Performance Characteristic Curves ISL60002, $V_{OUT} = 1.20V$ (Continued)

$V_{IN} = 3.0V$, $I_{OUT} = 0mA$, $T_A = +25^{\circ}C$ unless otherwise specified

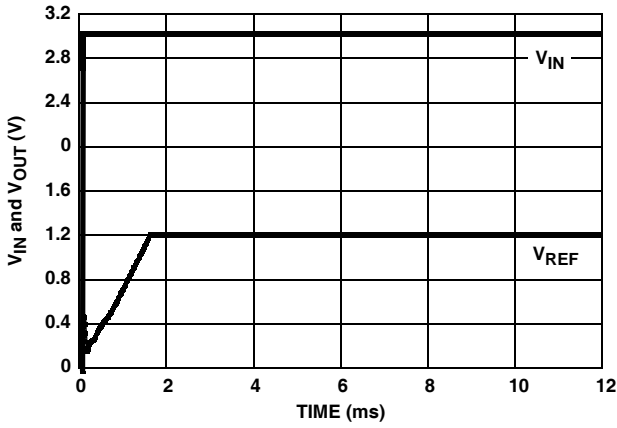

FIGURE 25. TURN-ON TIME (+25°C)

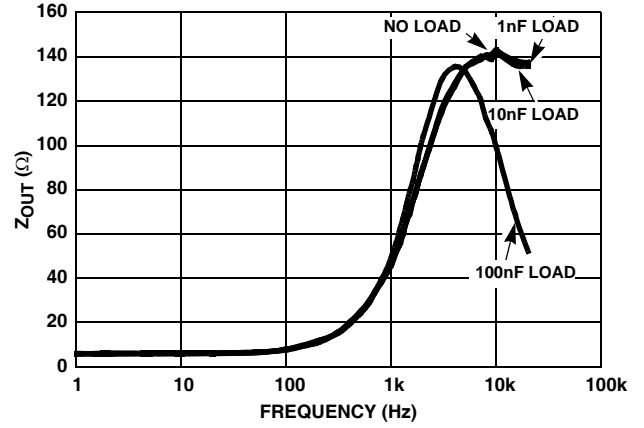

FIGURE 26. Z_{OUT} vs FREQUENCY

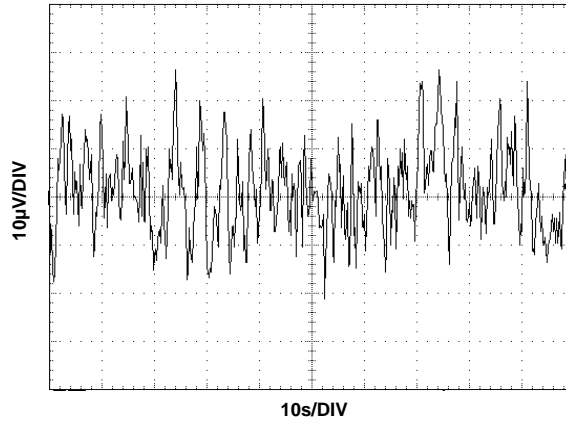

FIGURE 27. V_{OUT} NOISE

Typical Performance Characteristic Curves ISL60002, $V_{OUT} = 1.25V$

$V_{IN} = 3.0V$, $I_{OUT} = 0mA$, $T_A = +25^{\circ}C$ unless otherwise specified

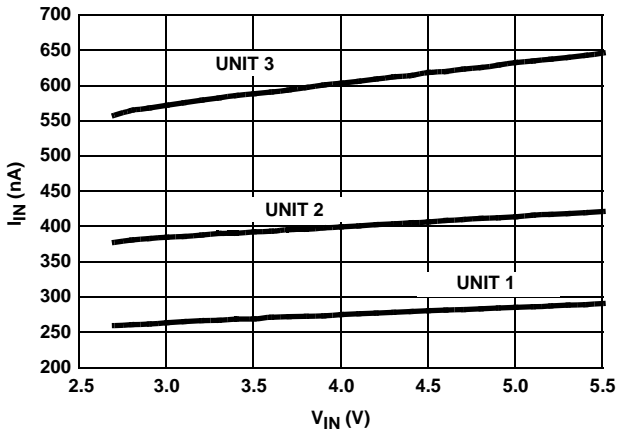

FIGURE 28. I_{IN} vs V_{IN} , 3 UNITS

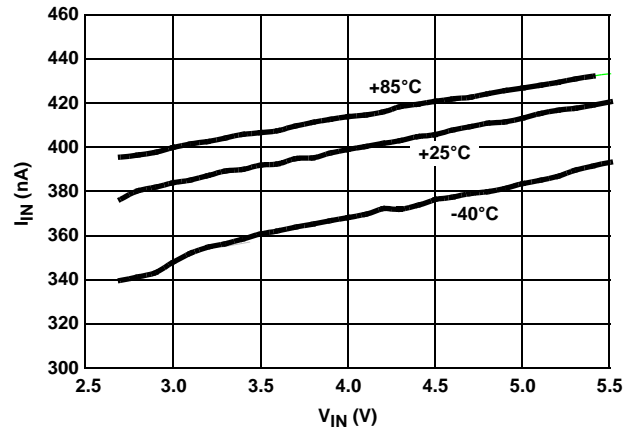

FIGURE 29. I_{IN} vs V_{IN} OVER-TEMPERATURE

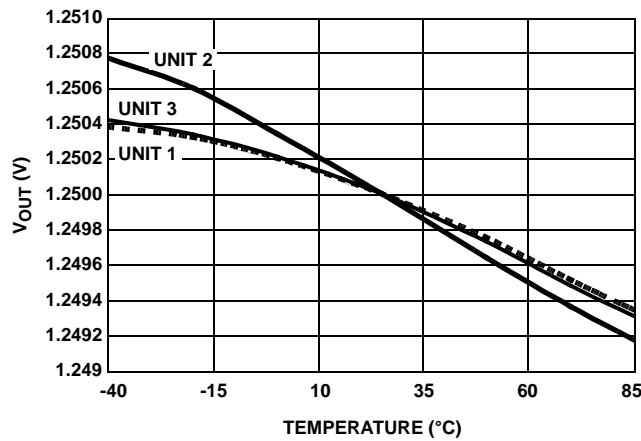

FIGURE 30. V_{OUT} vs TEMPERATURE NORMALIZED TO $+25^{\circ}C$

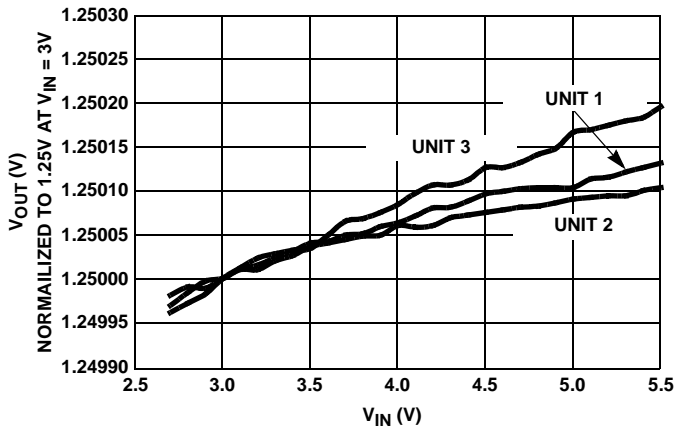

FIGURE 31. LINE REGULATION, 3 UNITS

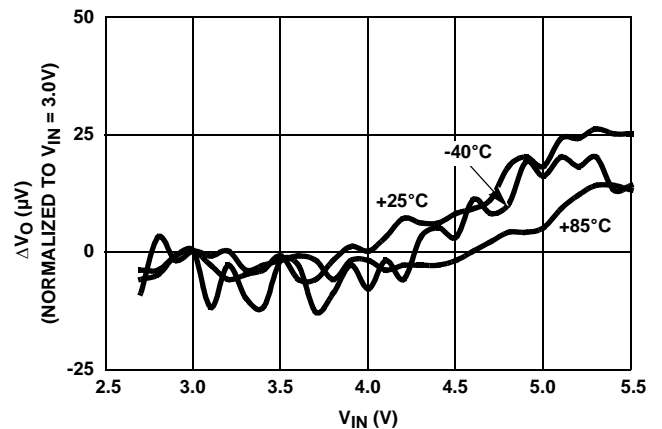

FIGURE 32. LINE REGULATION OVER-TEMPERATURE

Typical Performance Characteristic Curves ISL60002, $V_{OUT} = 1.25V$ (Continued)

$V_{IN} = 3.0V$, $I_{OUT} = 0mA$, $T_A = +25^\circ C$ unless otherwise specified

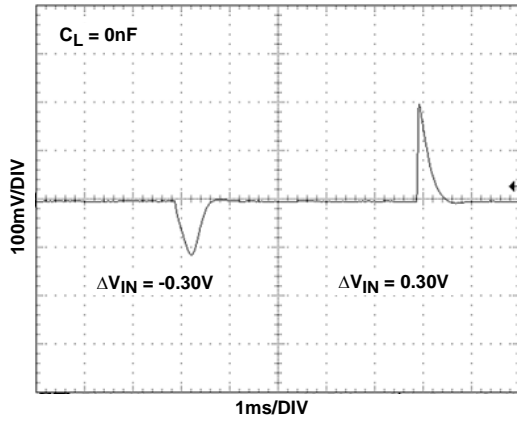

FIGURE 33. LINE TRANSIENT RESPONSE

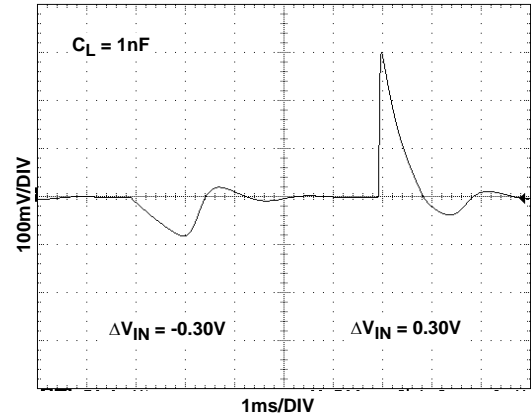

FIGURE 34. LINE TRANSIENT RESPONSE, WITH CAPACITIVE LOAD

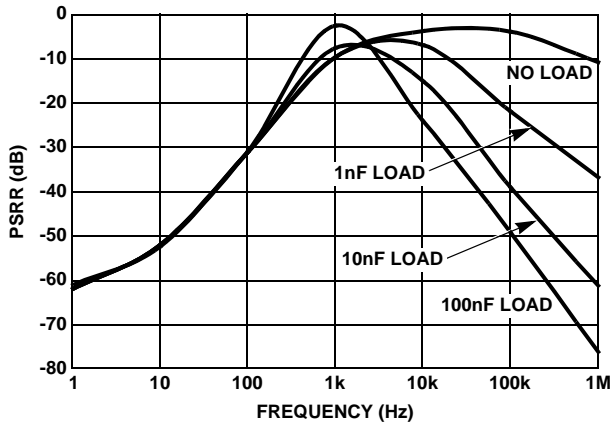

FIGURE 35. PSRR vs CAPACITIVE LOAD

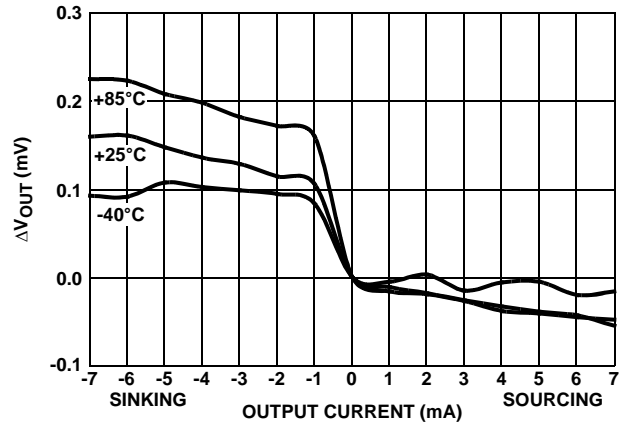

FIGURE 36. LOAD REGULATION

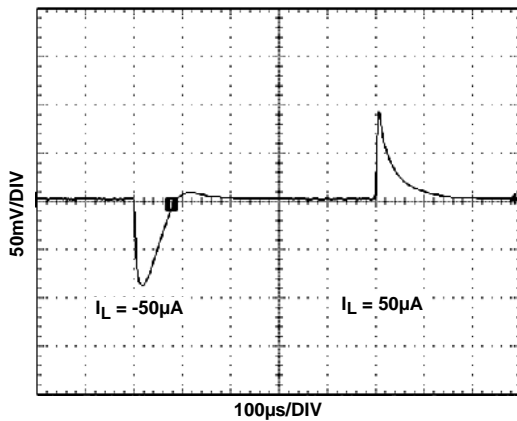

FIGURE 37. LOAD TRANSIENT RESPONSE

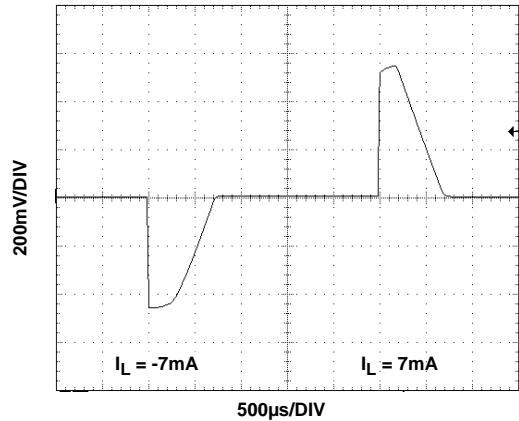

FIGURE 38. LOAD TRANSIENT RESPONSE

Typical Performance Characteristic Curves ISL60002, $V_{OUT} = 1.25V$ (Continued)

$V_{IN} = 3.0V$, $I_{OUT} = 0mA$, $T_A = +25^{\circ}C$ unless otherwise specified

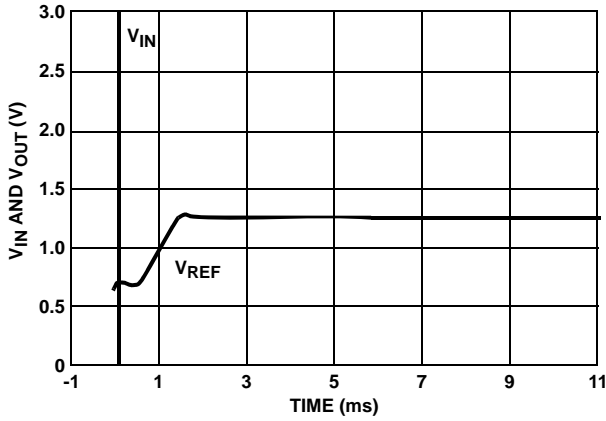

FIGURE 39. TURN-ON TIME (+25°C)

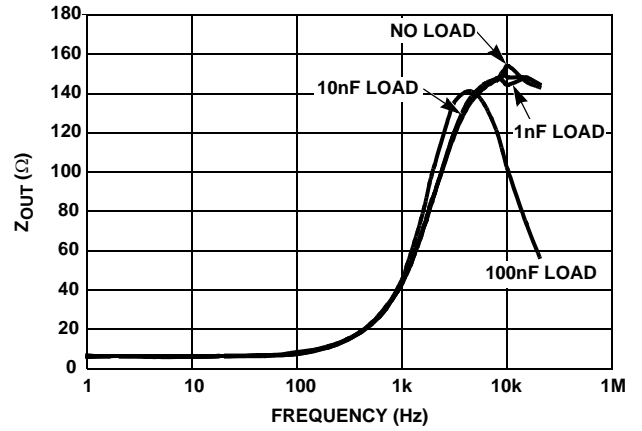

FIGURE 40. Z_{OUT} vs FREQUENCY

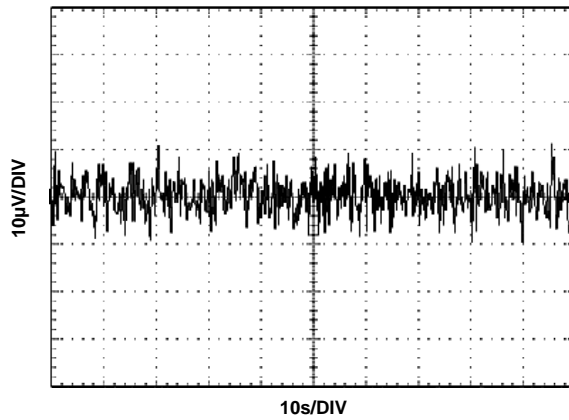

FIGURE 41. V_{OUT} NOISE

Typical Performance Curves ISL60002, $V_{OUT} = 1.8V$

$V_{IN} = 3.0V$, $I_{OUT} = 0mA$, $T_A = +25^{\circ}C$ unless otherwise specified

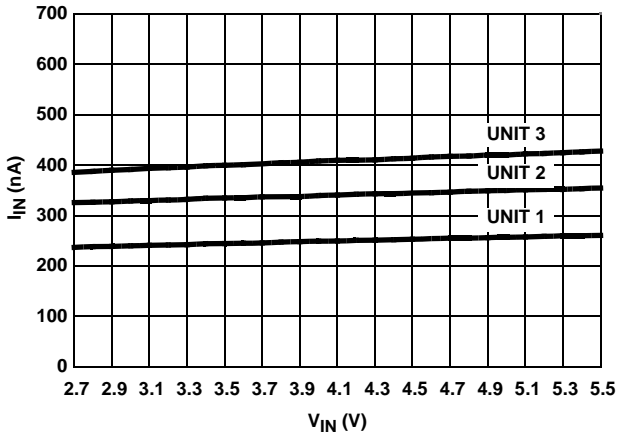

FIGURE 42. I_{IN} vs V_{IN} , 3 UNITS

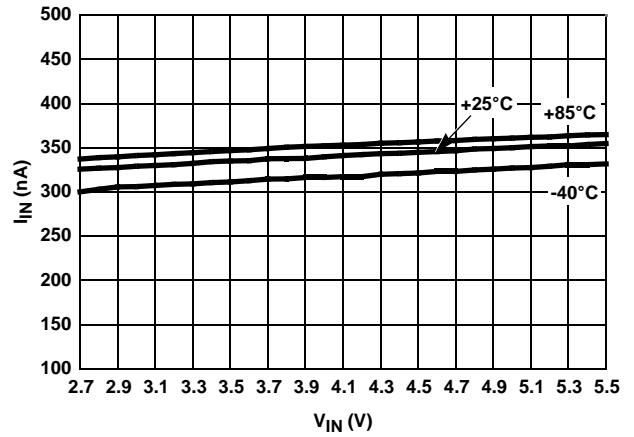

FIGURE 43. I_{IN} vs V_{IN} OVER-TEMPERATURE

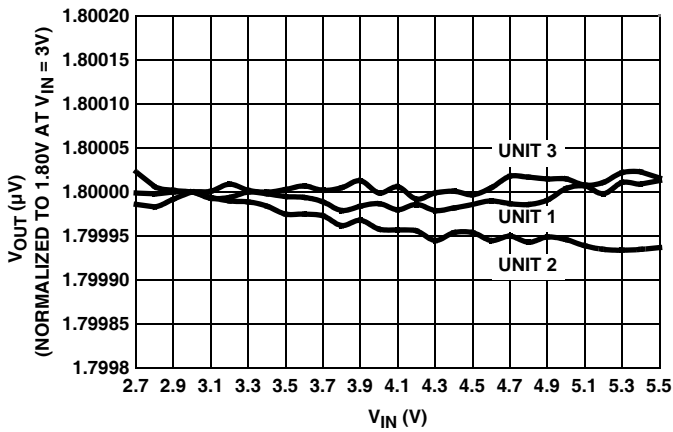

FIGURE 44. LINE REGULATION (3 REPRESENTATIVE UNITS)

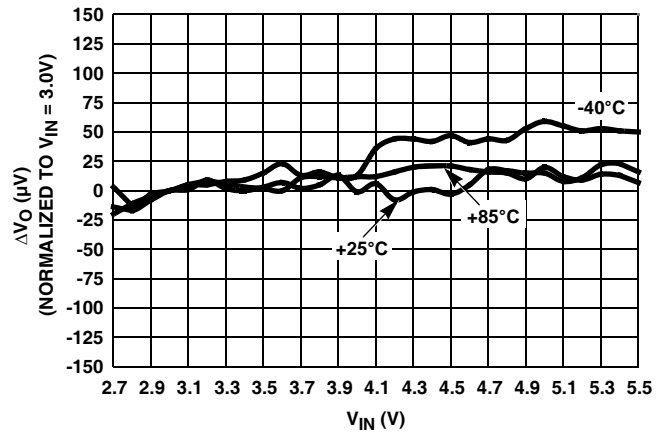

FIGURE 45. LINE REGULATION OVER-TEMPERATURE

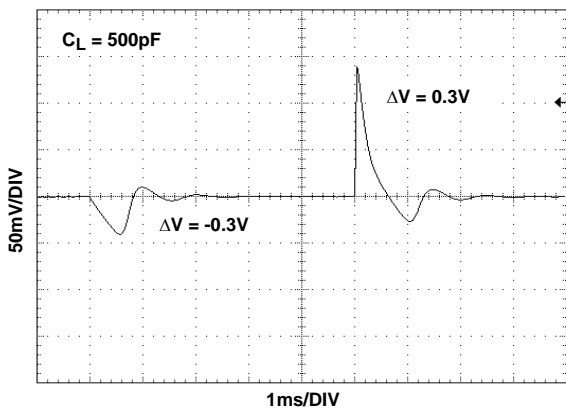

FIGURE 46. LINE TRANSIENT RESPONSE, WITH CAPACITIVE LOAD

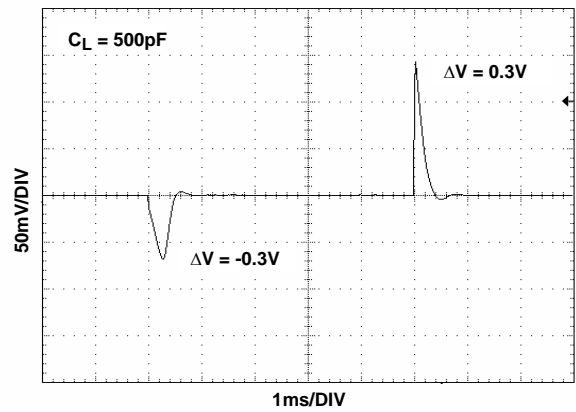

FIGURE 47. LINE TRANSIENT RESPONSE

Typical Performance Curves ISL60002, $V_{OUT} = 1.8V$ (Continued)

$V_{IN} = 3.0V$, $I_{OUT} = 0mA$, $T_A = +25^{\circ}C$ unless otherwise specified

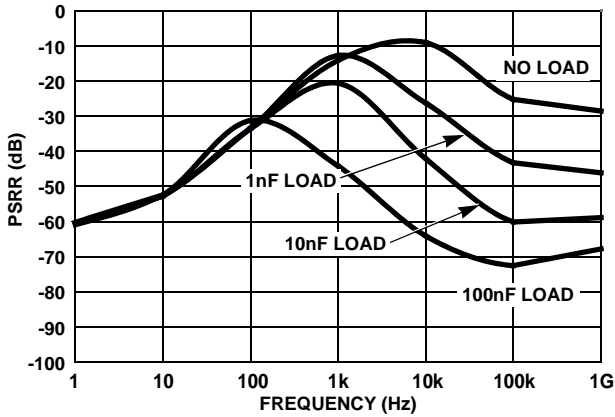

FIGURE 48. PSRR vs CAPACITIVE LOAD

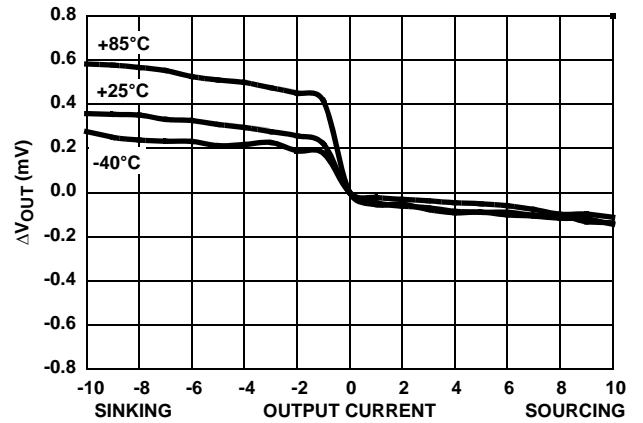

FIGURE 49. LOAD REGULATION OVER-TEMPERATURE

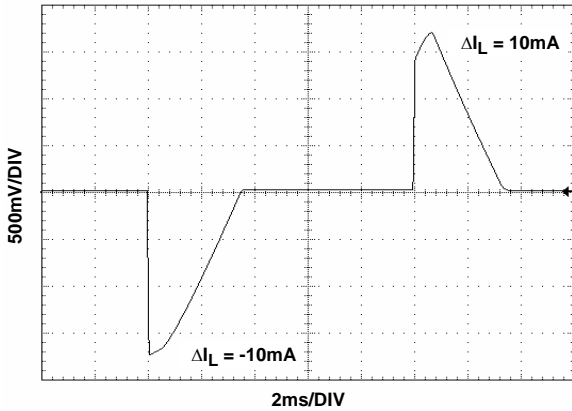

FIGURE 50. LOAD TRANSIENT RESPONSE

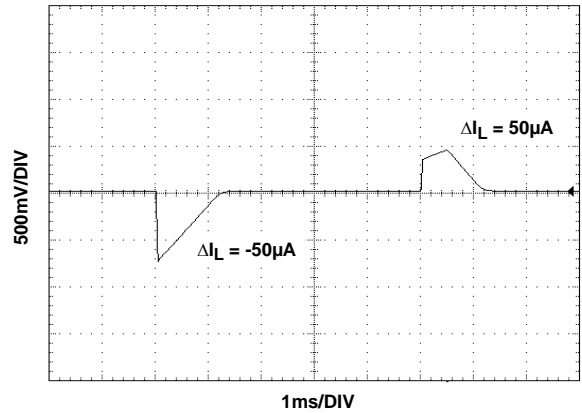

FIGURE 51. LOAD TRANSIENT RESPONSE

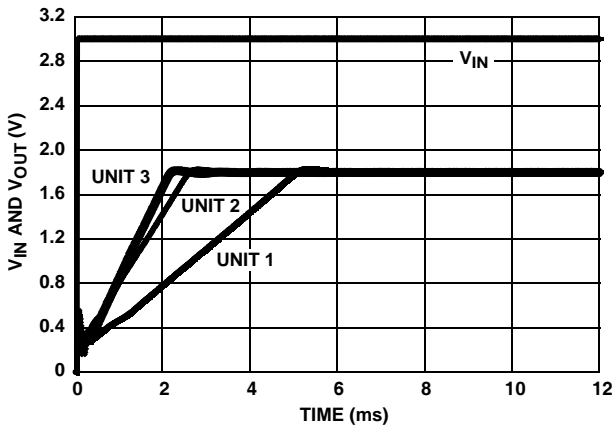

FIGURE 52. TURN-ON TIME (+25°C)

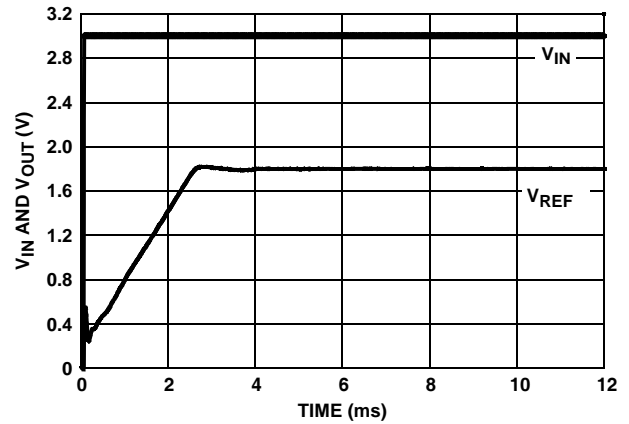

FIGURE 53. TURN-ON TIME (+25°C)

Typical Performance Curves ISL60002, $V_{OUT} = 1.8V$ (Continued)

$V_{IN} = 3.0V$, $I_{OUT} = 0mA$, $T_A = +25^{\circ}C$ unless otherwise specified

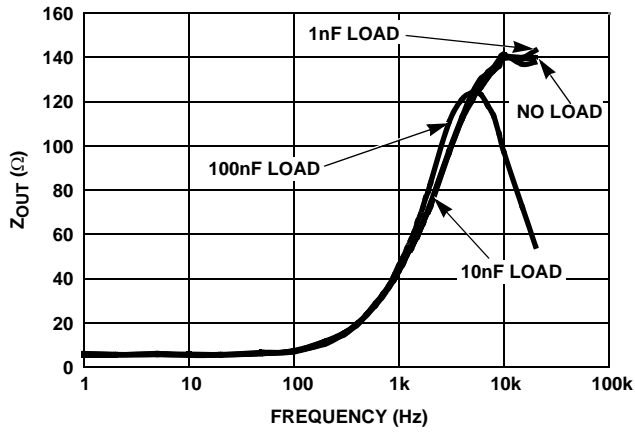

FIGURE 54. Z_{OUT} vs FREQUENCY

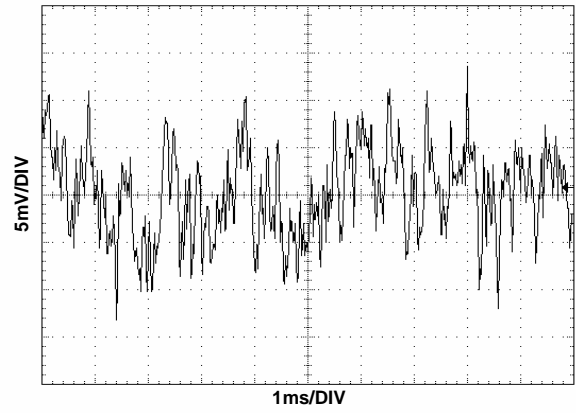

FIGURE 55. V_{OUT} NOISE

Typical Performance Curves ISL60002, $V_{OUT} = 2.048V$

$V_{IN} = 3.0V$, $I_{OUT} = 0mA$, $T_A = +25^{\circ}C$ unless otherwise specified

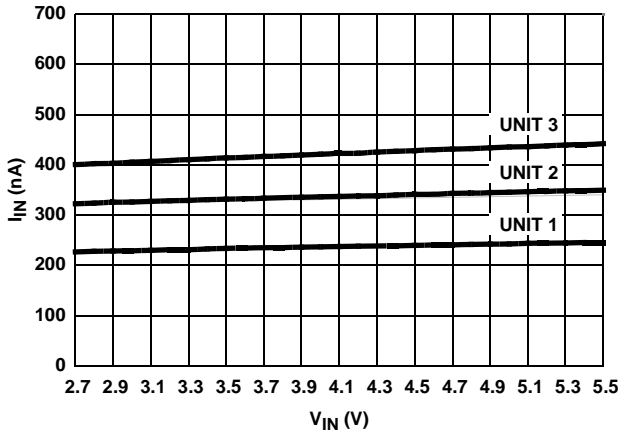

FIGURE 56. I_{IN} vs V_{IN} (3 REPRESENTATIVE UNITS)

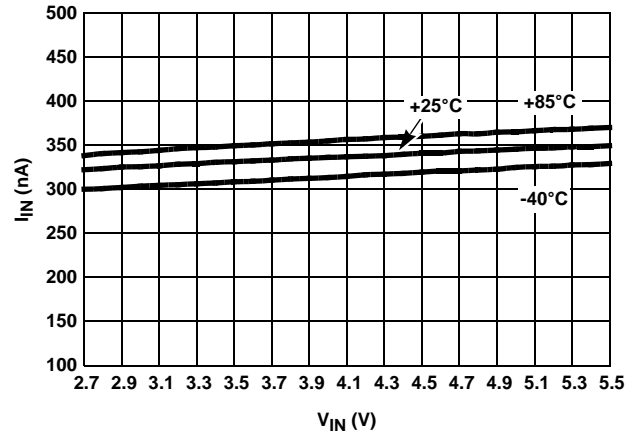

FIGURE 57. I_{IN} vs V_{IN} OVER-TEMPERATURE

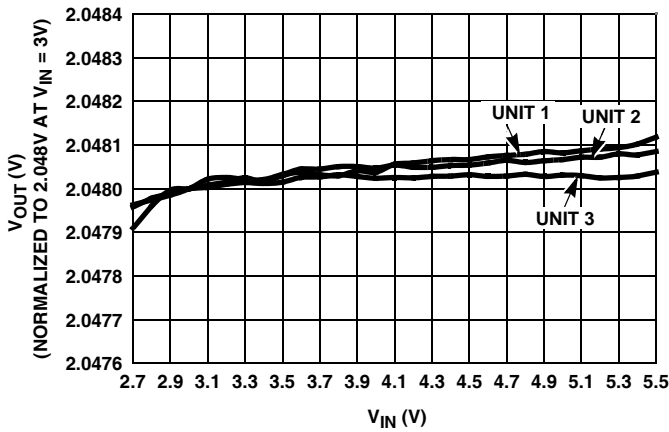

FIGURE 58. LINE REGULATION (3 REPRESENTATIVE UNITS)

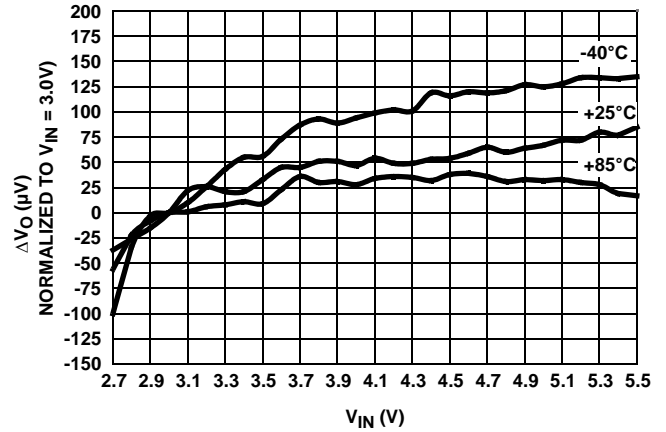

FIGURE 59. LINE REGULATION OVER-TEMPERATURE

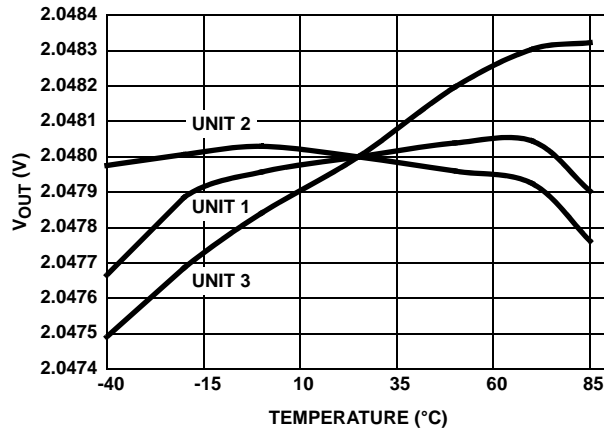

FIGURE 60. V_{OUT} vs TEMPERATURE NORMALIZED TO $+25^{\circ}C$

Typical Performance Curves ISL60002, $V_{OUT} = 2.048V$ (Continued)

$V_{IN} = 3.0V$, $I_{OUT} = 0mA$, $T_A = +25^{\circ}C$ unless otherwise specified

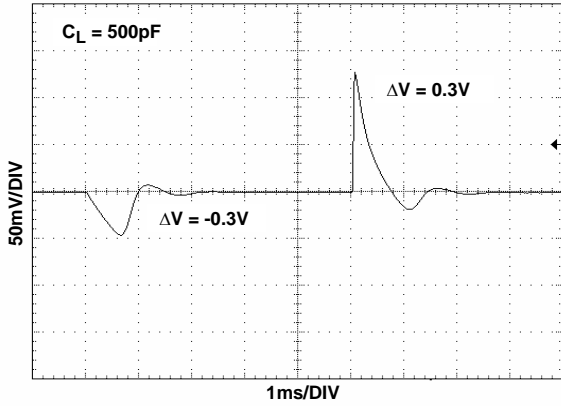

FIGURE 61. LINE TRANSIENT RESPONSE, WITH CAPACITIVE LOAD

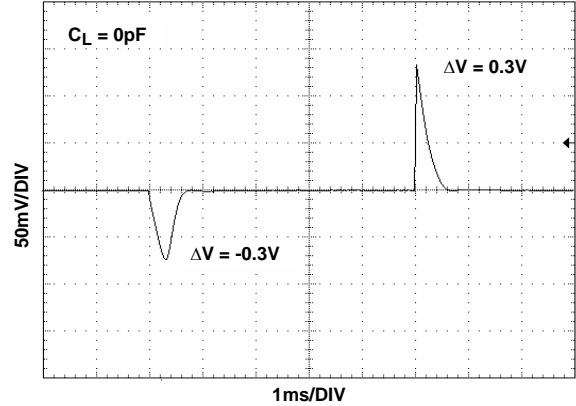

FIGURE 62. LINE TRANSIENT RESPONSE

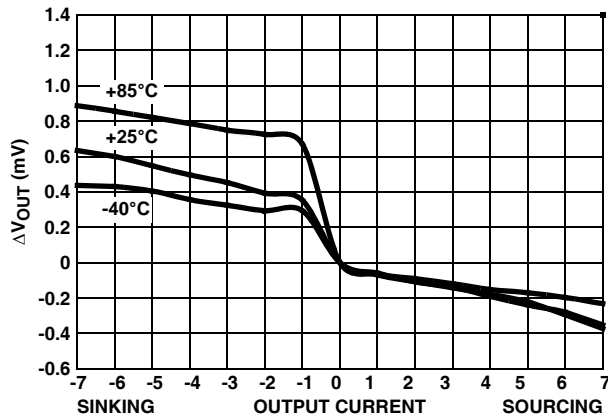

FIGURE 63. LOAD REGULATION OVER-TEMPERATURE

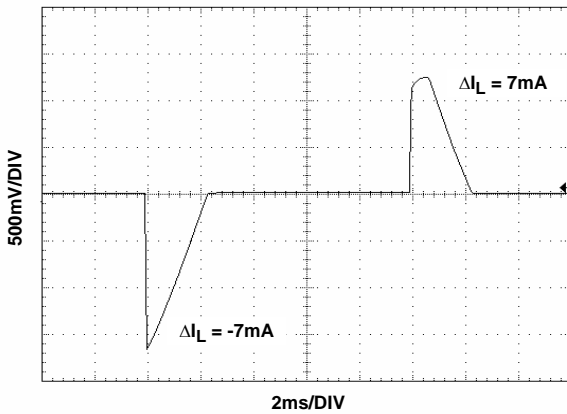

FIGURE 64. LOAD TRANSIENT RESPONSE

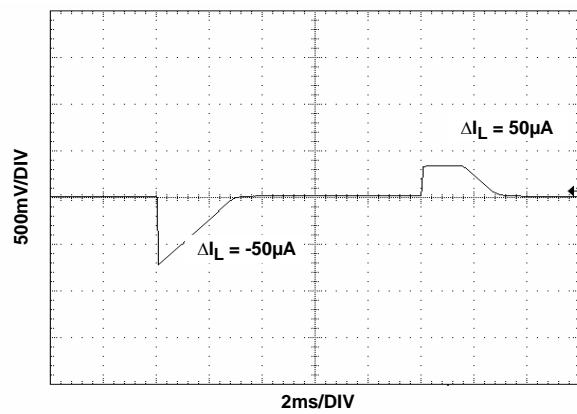

FIGURE 65. LOAD TRANSIENT RESPONSE

Typical Performance Curves ISL60002, $V_{OUT} = 2.048V$ (Continued)

$V_{IN} = 3.0V$, $I_{OUT} = 0mA$, $T_A = +25^{\circ}C$ unless otherwise specified

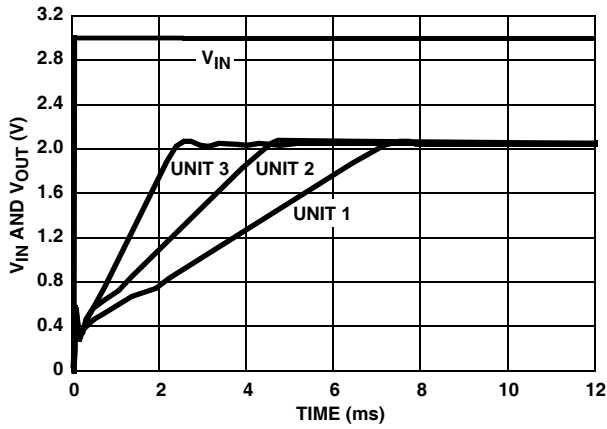

FIGURE 66. TURN-ON TIME (+25°C)

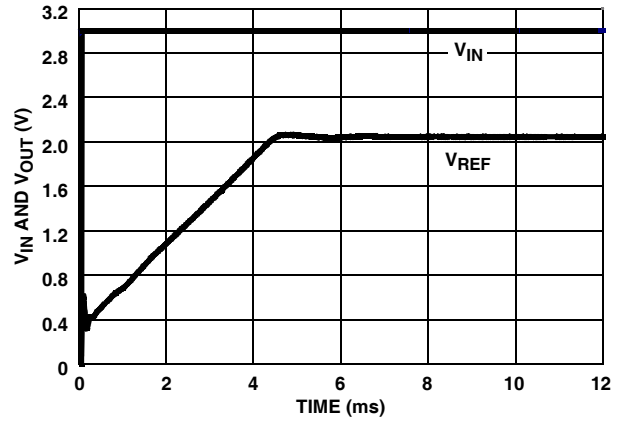

FIGURE 67. TURN-ON TIME (+25°C)

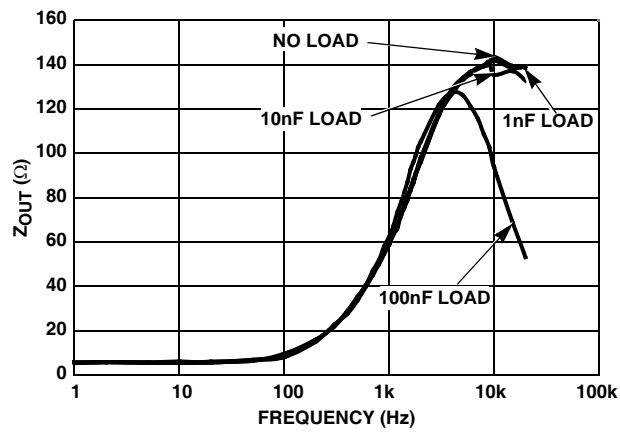

FIGURE 68. Z_{OUT} vs FREQUENCY

Typical Performance Characteristic Curves ISL60002, $V_{OUT} = 2.50V$

$V_{IN} = 3.0V$, $I_{OUT} = 0mA$, $T_A = +25^\circ C$ unless otherwise specified

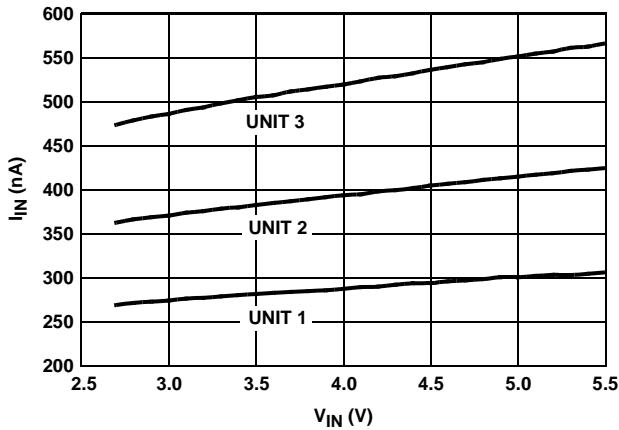

FIGURE 69. I_{IN} vs V_{IN} , 3 UNITS

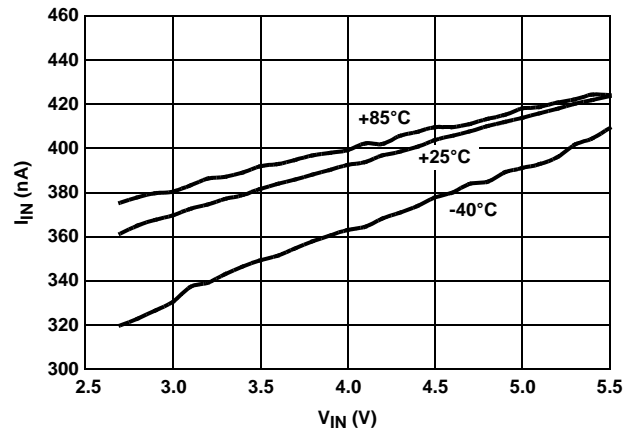

FIGURE 70. I_{IN} vs V_{IN} OVER-TEMPERATURE

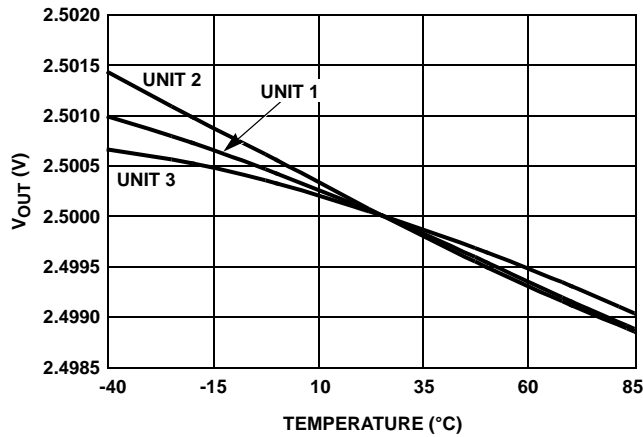

FIGURE 71. V_{OUT} vs TEMPERATURE NORMALIZED TO $+25^\circ C$

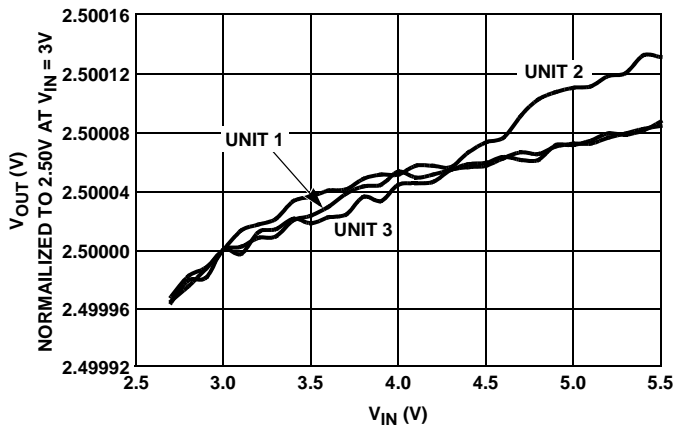

FIGURE 72. LINE REGULATION, 3 UNITS

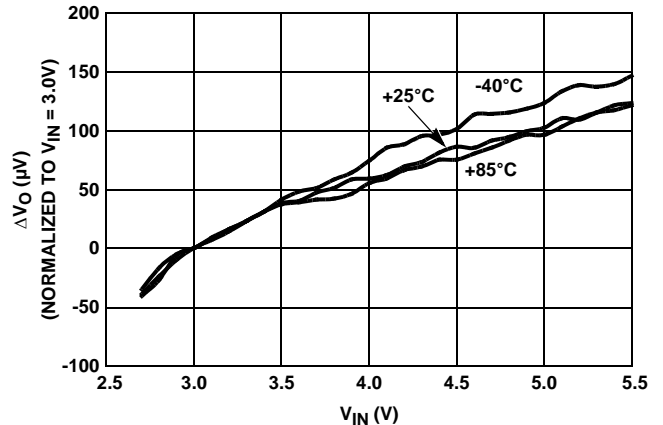

FIGURE 73. LINE REGULATION OVER-TEMPERATURE

Typical Performance Characteristic Curves ISL60002, $V_{OUT} = 2.50V$ (Continued)

$V_{IN} = 3.0V$, $I_{OUT} = 0mA$, $T_A = +25^\circ C$ unless otherwise specified

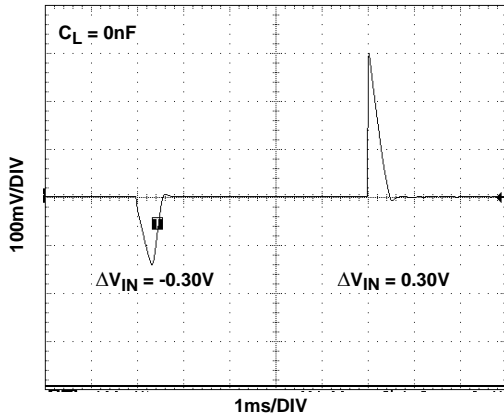

FIGURE 74. LINE TRANSIENT RESPONSE

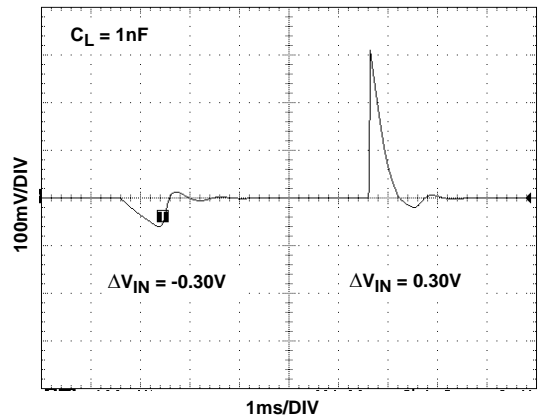

FIGURE 75. LINE TRANSIENT RESPONSE

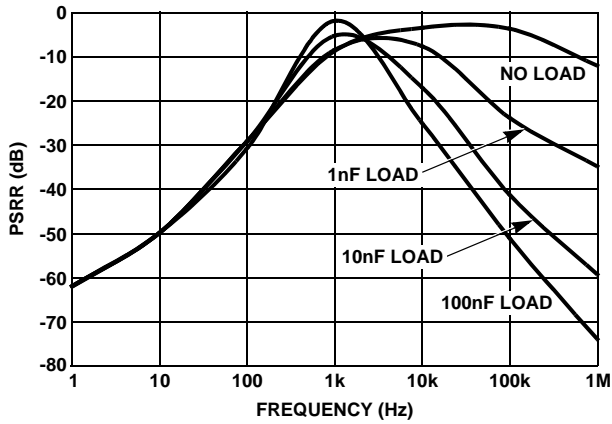

FIGURE 76. PSRR vs CAPACITIVE LOAD

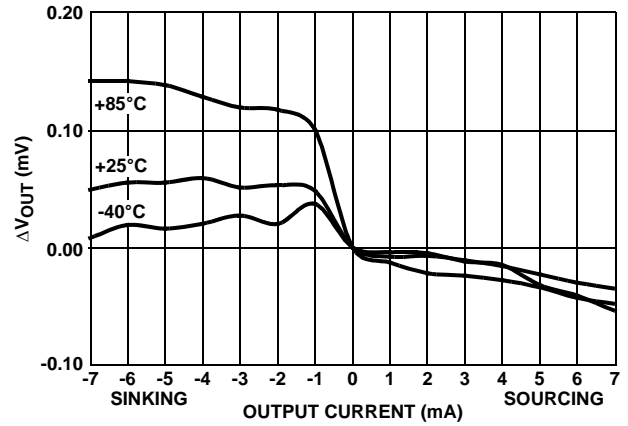

FIGURE 77. LOAD REGULATION OVER-TEMPERATURE

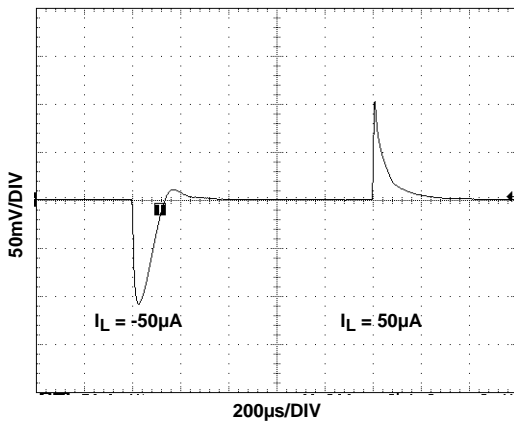

FIGURE 78. LOAD TRANSIENT RESPONSE

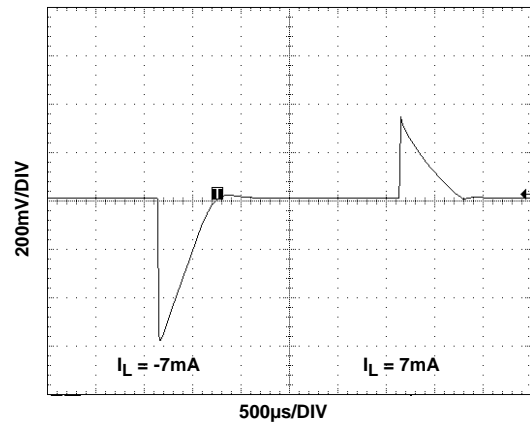

FIGURE 79. LOAD TRANSIENT RESPONSE

Typical Performance Characteristic Curves ISL60002, $V_{OUT} = 2.50V$ (Continued)

$V_{IN} = 3.0V$, $I_{OUT} = 0mA$, $T_A = +25^{\circ}C$ unless otherwise specified

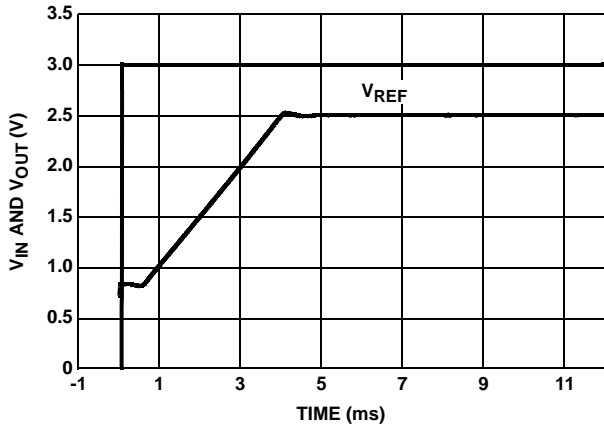

FIGURE 80. TURN-ON TIME (+25°C)

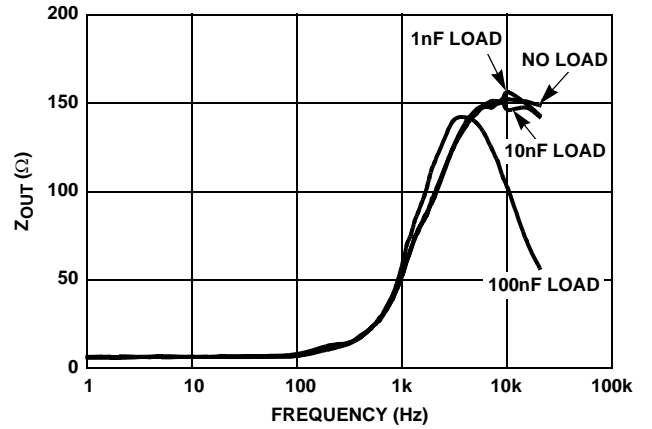

FIGURE 81. Z_{OUT} vs FREQUENCY

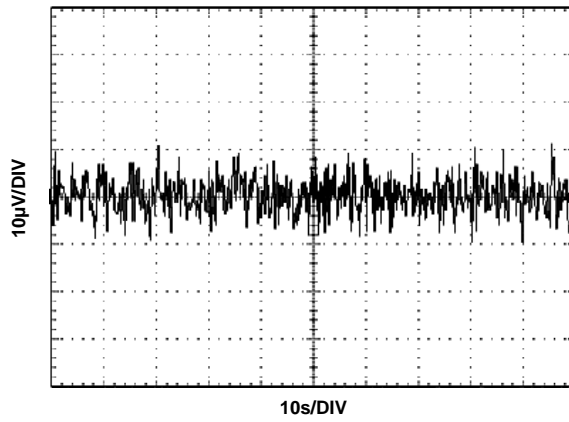

FIGURE 82. V_{OUT} NOISE

Typical Performance Characteristic Curves ISL60002, $V_{OUT} = 3.0V$

$V_{IN} = 5.0V$, $I_{OUT} = 0mA$, $T_A = +25^\circ C$ unless otherwise specified

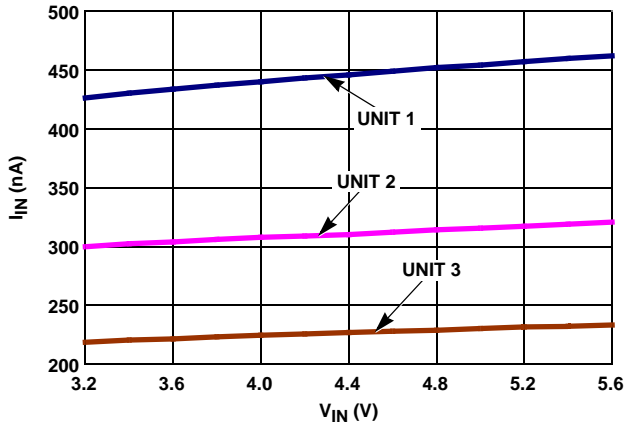

FIGURE 83. I_{IN} vs V_{IN} , 3 UNITS

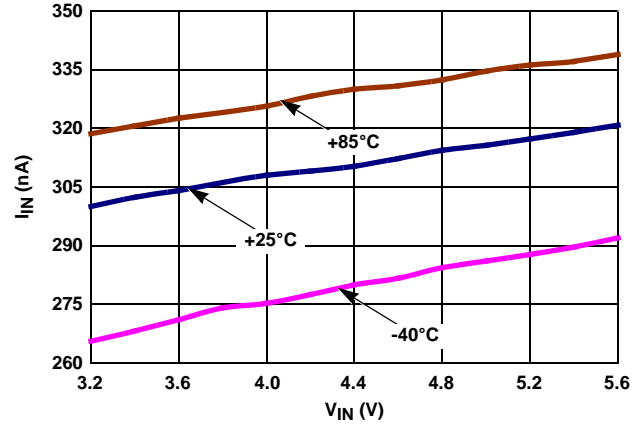

FIGURE 84. I_{IN} vs V_{IN} OVER TEMPERATURE

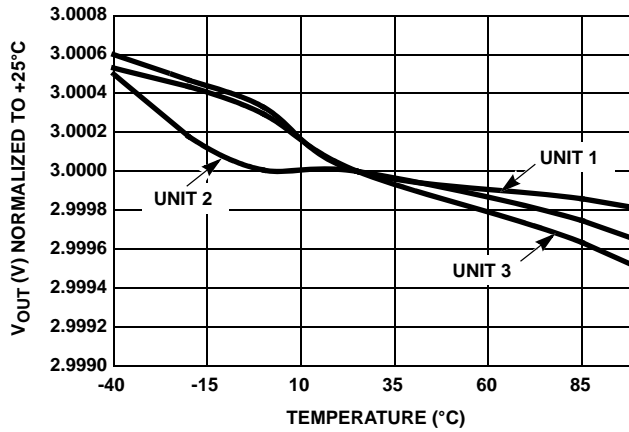

FIGURE 85. V_{OUT} vs TEMPERATURE NORMALIZED TO $+25^\circ C$

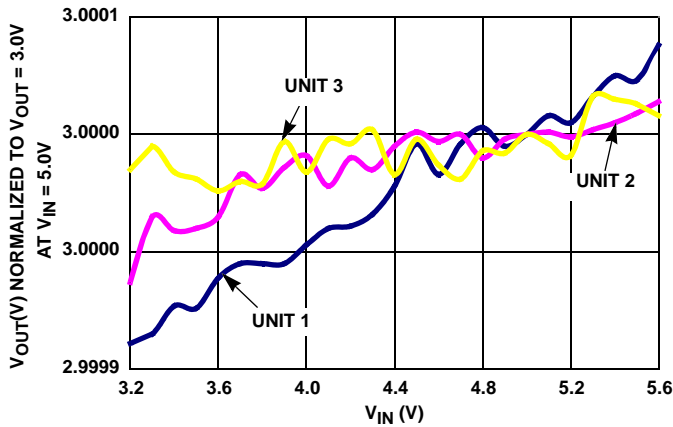

FIGURE 86. LINE REGULATION (3 REPRESENTATIVE UNITS)

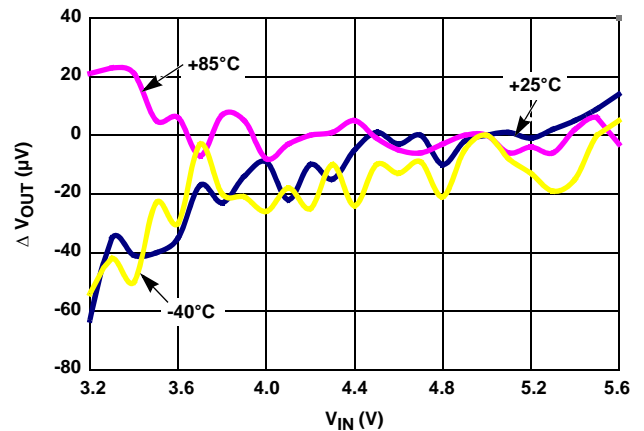

FIGURE 87. LINE REGULATION OVER-TEMPERATURE

Typical Performance Characteristic Curves ISL60002, $V_{OUT} = 3.0V$ (Continued)

$V_{IN} = 5.0V$, $I_{OUT} = 0mA$, $T_A = +25^\circ C$ unless otherwise specified

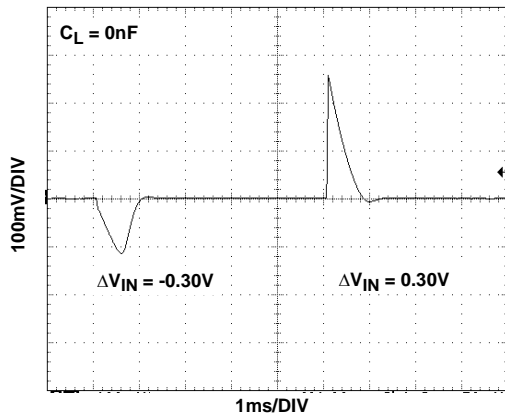

FIGURE 88. LINE TRANSIENT RESPONSE

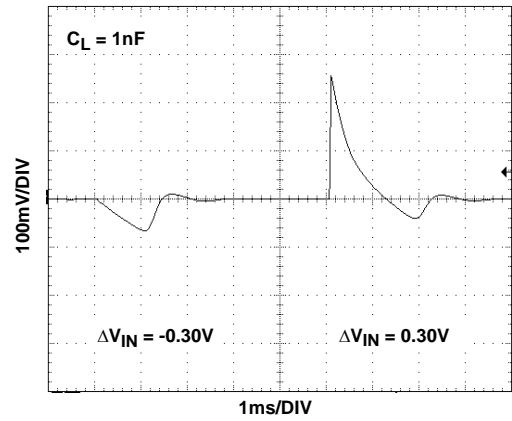

FIGURE 89. LINE TRANSIENT RESPONSE

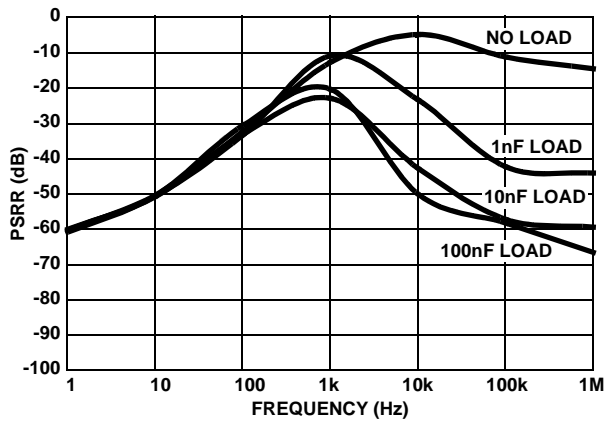

FIGURE 90. PSRR vs CAPACITIVE LOAD

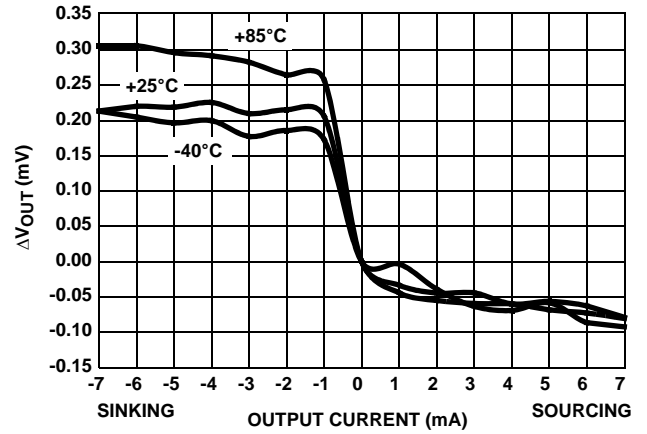

FIGURE 91. LOAD REGULATION OVER-TEMPERATURE

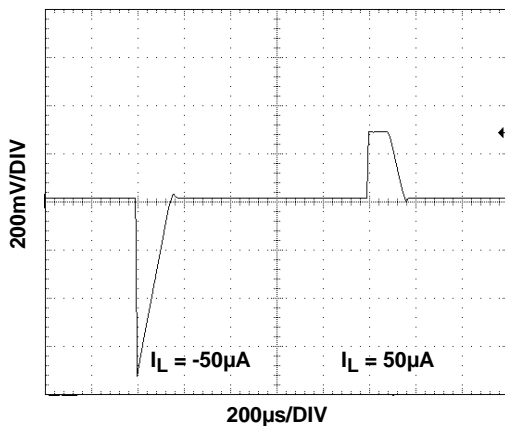

FIGURE 92. LOAD TRANSIENT RESPONSE

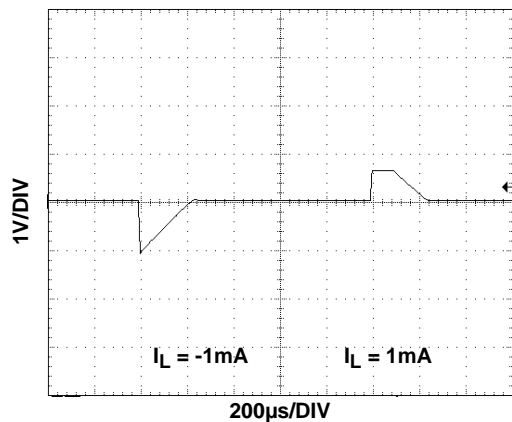

FIGURE 93. LOAD TRANSIENT RESPONSE

Typical Performance Characteristic Curves ISL60002, $V_{OUT} = 3.0V$ (Continued)

$V_{IN} = 5.0V$, $I_{OUT} = 0mA$, $T_A = +25^\circ C$ unless otherwise specified

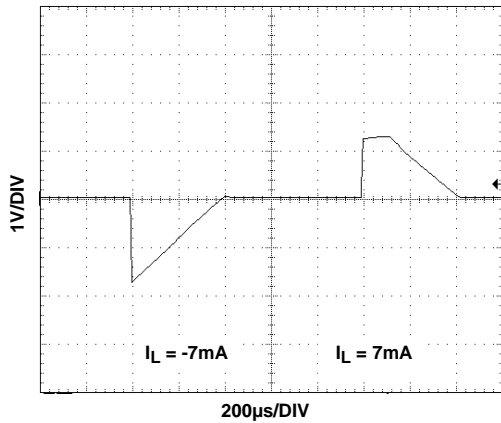

FIGURE 94. LOAD TRANSIENT RESPONSE

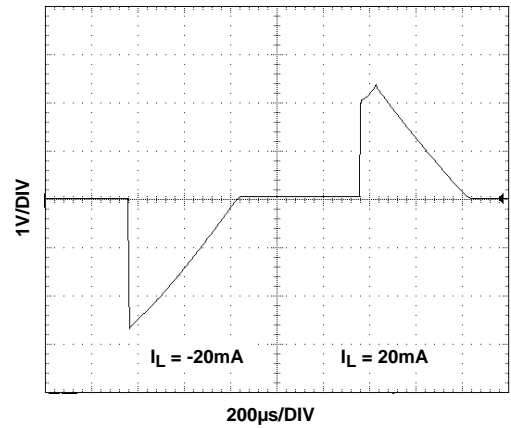

FIGURE 95. LOAD TRANSIENT RESPONSE

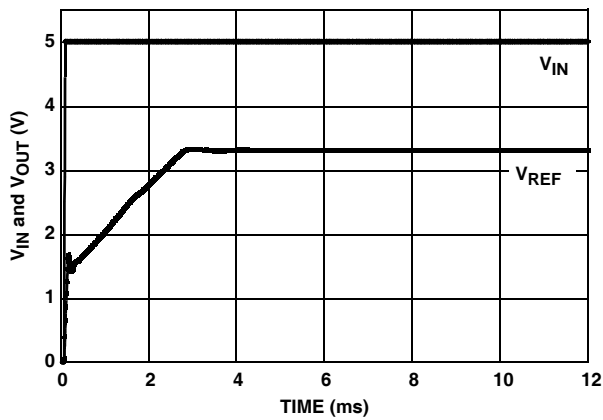

FIGURE 96. TURN-ON TIME ($+25^\circ C$)

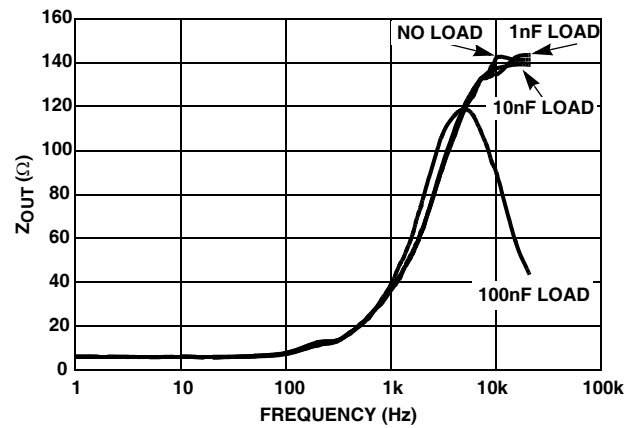

FIGURE 97. Z_{OUT} vs FREQUENCY

Typical Performance Characteristic Curves ISL60002, $V_{OUT} = 3.3V$

$V_{IN} = 5.0V$, $I_{OUT} = 0mA$, $T_A = +25^\circ C$ unless otherwise specified

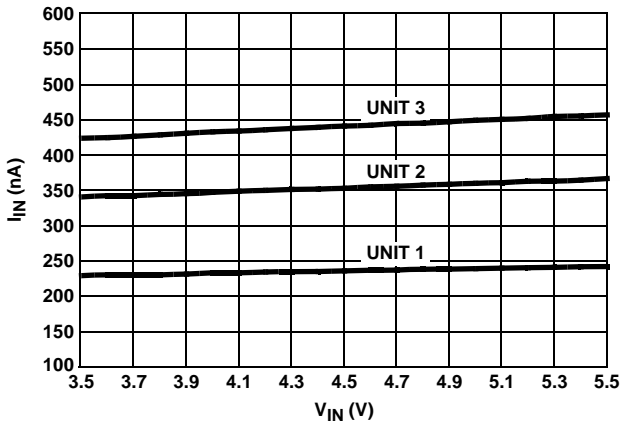

FIGURE 98. I_{IN} vs V_{IN} , 3 UNITS

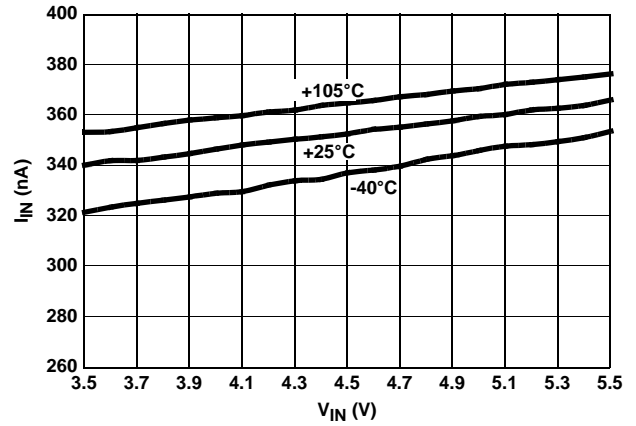

FIGURE 99. I_{IN} vs V_{IN} OVER-TEMPERATURE

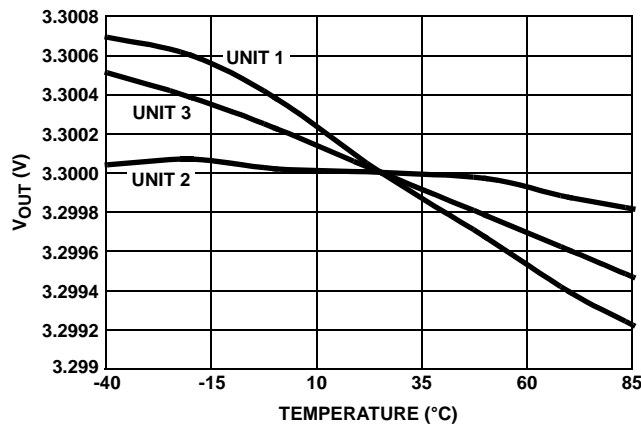

FIGURE 100. V_{OUT} vs TEMPERATURE NORMALIZED TO $+25^\circ C$

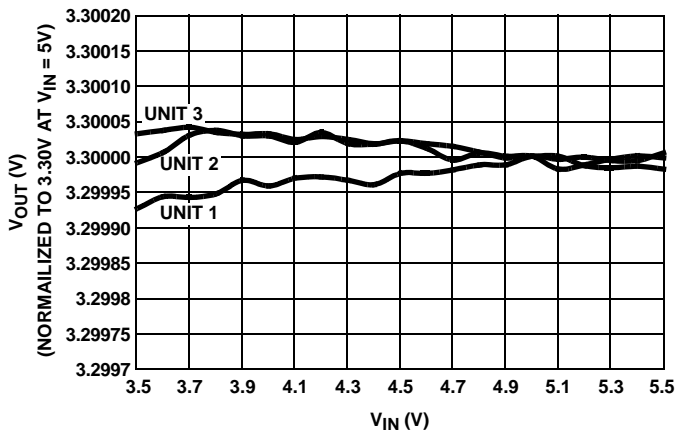

FIGURE 101. LINE REGULATION, 3 UNITS

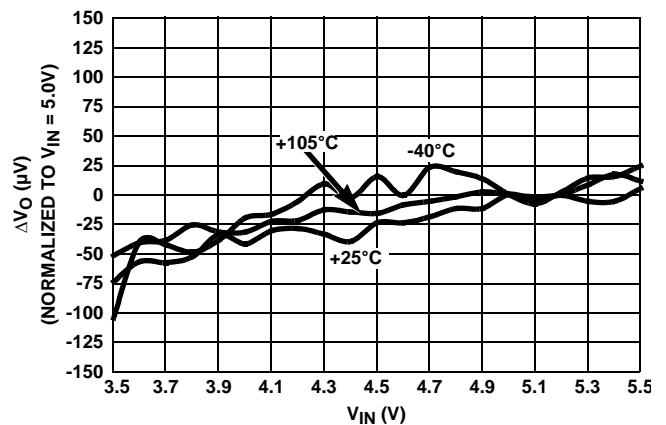

FIGURE 102. LINE REGULATION OVER-TEMPERATURE

Typical Performance Characteristic Curves ISL60002, $V_{OUT} = 3.3V$ (Continued)

$V_{IN} = 5.0V$, $I_{OUT} = 0mA$, $T_A = +25^{\circ}C$ unless otherwise specified

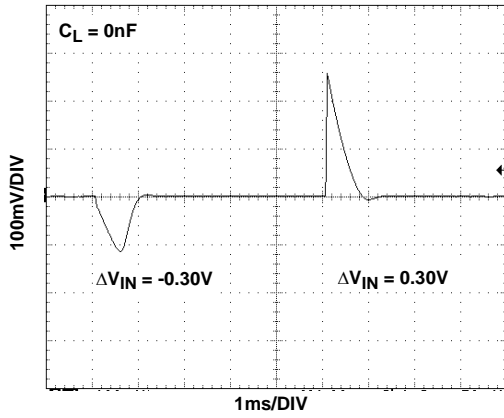

FIGURE 103. LINE TRANSIENT RESPONSE

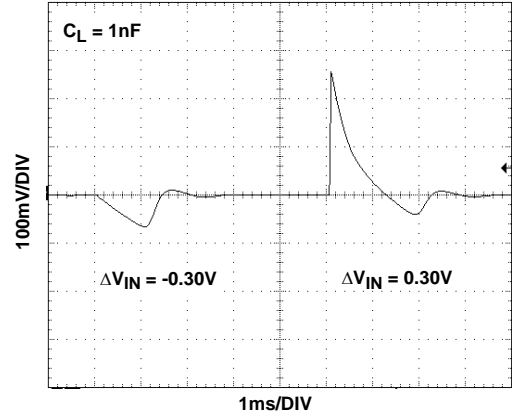

FIGURE 104. LINE TRANSIENT RESPONSE

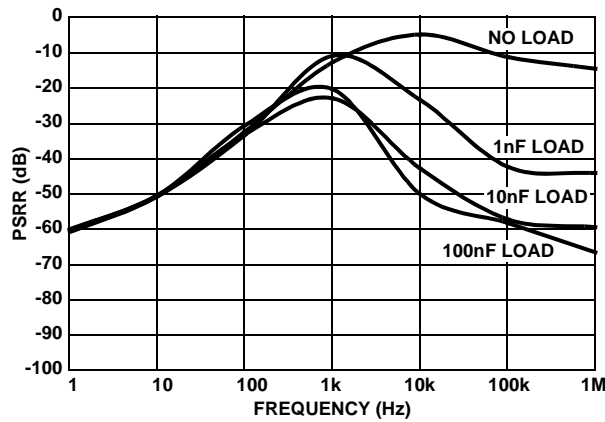

FIGURE 105. PSRR vs CAPACITIVE LOAD

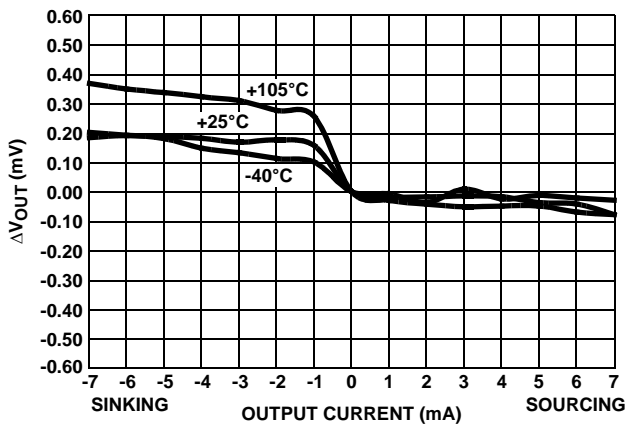

FIGURE 106. LOAD REGULATION

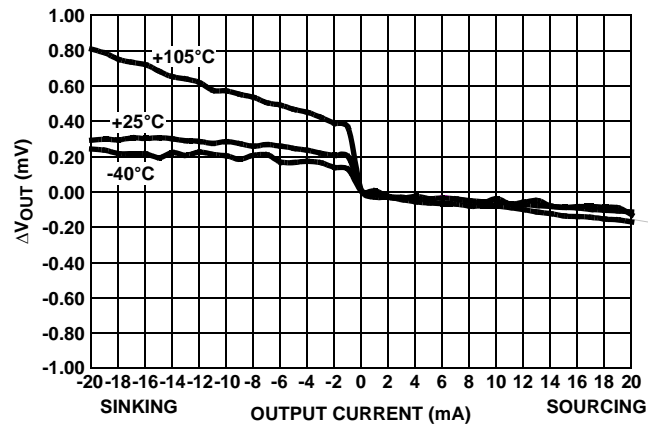

FIGURE 107. LOAD REGULATION OVER-TEMPERATURE

Typical Performance Characteristic Curves ISL60002, $V_{OUT} = 3.3V$ (Continued)

$V_{IN} = 5.0V$, $I_{OUT} = 0mA$, $T_A = +25^\circ C$ unless otherwise specified

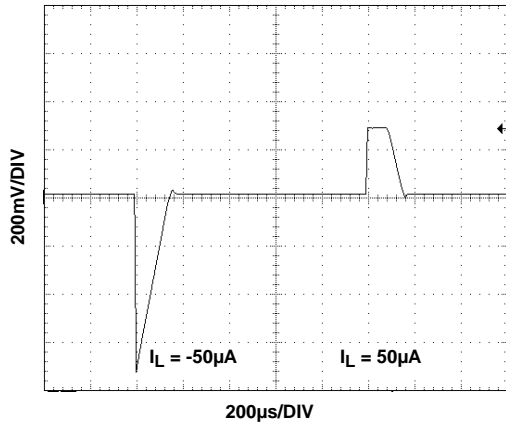

FIGURE 108. LOAD TRANSIENT RESPONSE

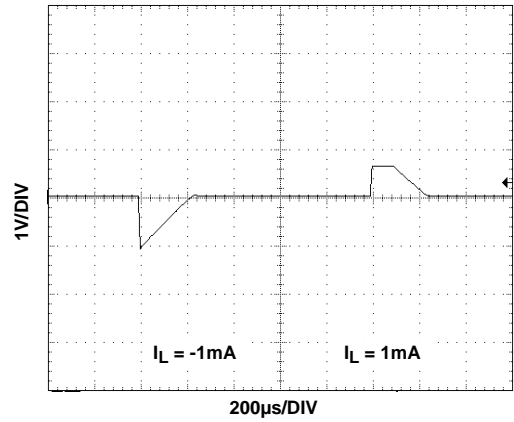

FIGURE 109. LOAD TRANSIENT RESPONSE

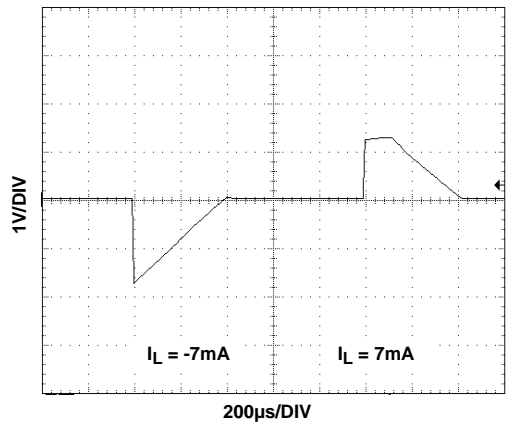

FIGURE 110. LOAD TRANSIENT RESPONSE

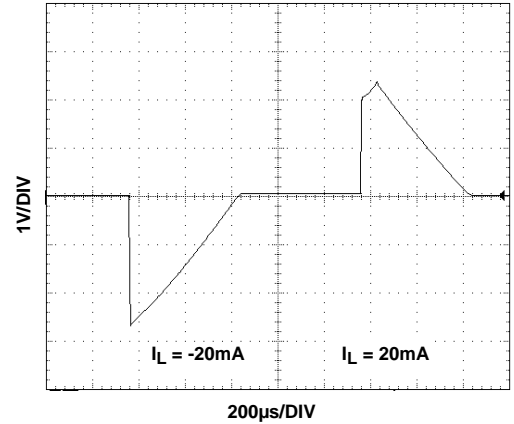

FIGURE 111. LOAD TRANSIENT RESPONSE

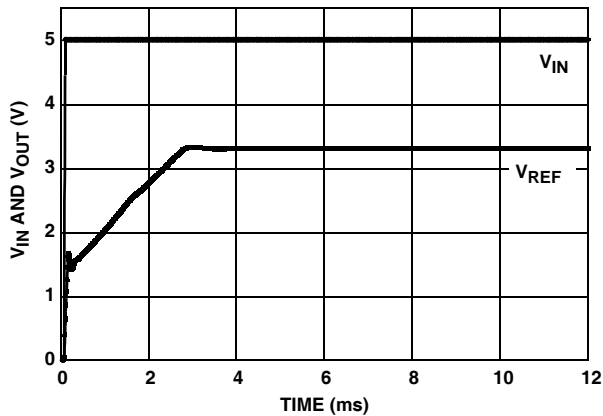

FIGURE 112. TURN-ON TIME (+25°C)

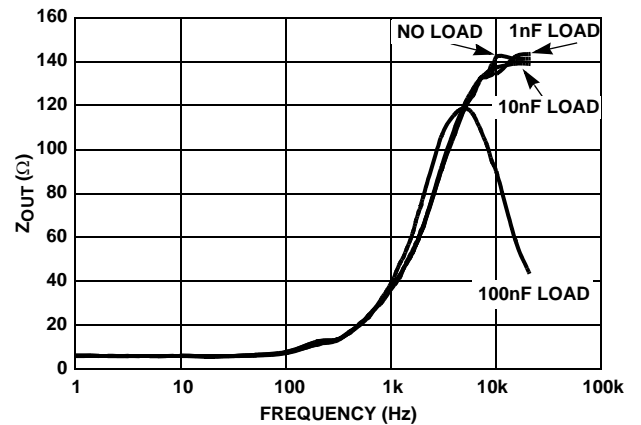

FIGURE 113. Z_{OUT} vs FREQUENCY

High Current Application

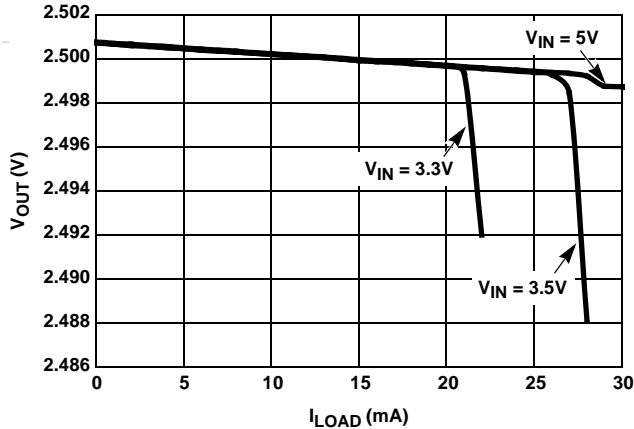

FIGURE 114. DIFFERENT V_{IN} AT ROOM TEMPERATURE

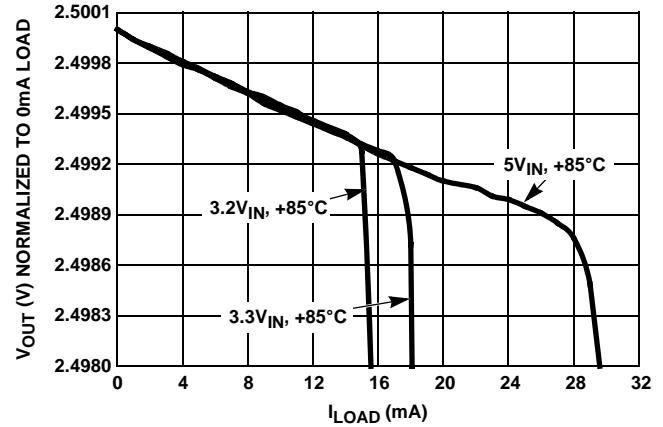

FIGURE 115. DIFFERENT V_{IN} AT HIGH TEMPERATURE

Applications Information

FGA Technology

The ISL60002 series of voltage references use the floating gate technology to create references with very low drift and supply current. Essentially, the charge stored on a floating gate cell is set precisely in manufacturing. The reference voltage output itself is a buffered version of the floating gate voltage. The resulting reference device has excellent characteristics which are unique in the industry: very low temperature drift, high initial accuracy, and almost zero supply current. Also, the reference voltage itself is not limited by voltage bandgaps or zener settings, so a wide range of reference voltages can be programmed (standard voltage settings are provided, but customer-specific voltages are available).

The process used for these reference devices is a floating gate CMOS process, and the amplifier circuitry uses CMOS transistors for amplifier and output transistor circuitry. While providing excellent accuracy, there are limitations in output noise level and load regulation due to the MOS device characteristics. These limitations are addressed with circuit techniques discussed in other sections.

Nanopower Operation

Reference devices achieve their highest accuracy when powered up continuously, and after initial stabilization has taken place. This drift can be eliminated by leaving the power on continuously.

The ISL60002 is the first high precision voltage reference with ultra low power consumption that makes it possible to leave power on continuously in battery operated circuits. The ISL60002 consumes extremely low supply current due to the proprietary FGA technology. Supply current at room temperature is typically 350nA, which is 1 to 2 orders of magnitude lower than competitive devices. Application circuits using battery power will benefit greatly from having an accurate, stable reference, which essentially presents no load to the battery.

In particular, battery powered data converter circuits that would normally require the entire circuit to be disabled when not in use can remain powered up between conversions as shown in Figure 116. Data acquisition circuits providing 12 to 24 bits of accuracy can operate with the reference device continuously biased with no power penalty, providing the highest accuracy and lowest possible long term drift.

Other reference devices consuming higher supply currents will need to be disabled in between conversions to conserve battery capacity. Absolute accuracy will suffer as the device is biased and requires time to settle to its final value, or, may not actually settle to a final value as power on time may be short.

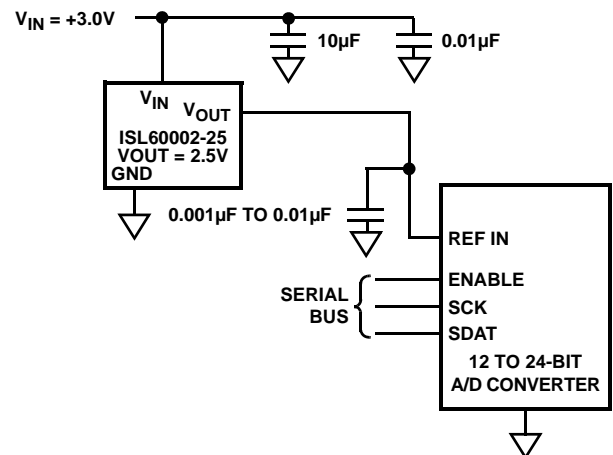

FIGURE 116.

Board Mounting Considerations

For applications requiring the highest accuracy, board mounting location should be reviewed. Placing the device in areas subject to slight twisting can cause degradation of the accuracy of the reference voltage due to die stresses. It is normally best to place the device near the edge of a board, or the shortest side, as the axis of bending is most limited at that location. Obviously mounting the device on flexprint or extremely thin PC material will likewise cause loss of reference accuracy.

Noise Performance and Reduction

The output noise voltage in a 0.1Hz to 10Hz bandwidth is typically $30\mu V_{P-P}$. This is shown in the plot in the Typical Performance Curves. The noise measurement is made with a bandpass filter made of a 1 pole high-pass filter with a corner frequency at 0.1Hz and a 2-pole low-pass filter with a corner frequency at 12.6Hz to create a filter with a 9.9Hz bandwidth. Noise in the 10kHz to 1MHz bandwidth is approximately $400\mu V_{P-P}$ with no capacitance on the output, as shown in Figure 117. These noise measurements are made with a 2 decade bandpass filter made of a 1 pole high-pass filter with a corner frequency at 1/10 of the center frequency and 1-pole low-pass filter with a corner frequency at 10 times the center frequency. Figure 117 also shows the noise in the 10kHz to 1MHz band can be reduced to about $50\mu V_{P-P}$ using a $0.001\mu F$ capacitor on the output. Noise in the 1kHz to 100kHz band can be further reduced using a $0.1\mu F$ capacitor on the output, but noise in the 1Hz to 100Hz band increases due to instability of the very low power amplifier with a $0.1\mu F$ capacitance load. For load capacitances above $0.001\mu F$ the noise reduction network shown in Figure 118 is recommended. This network reduces noise significantly over the full bandwidth. As shown in Figure 117, noise is reduced to less than $40\mu V_{P-P}$ from 1Hz to 1MHz using this network with a $0.01\mu F$ capacitor and a $2k\Omega$ resistor in series with a $10\mu F$ capacitor.

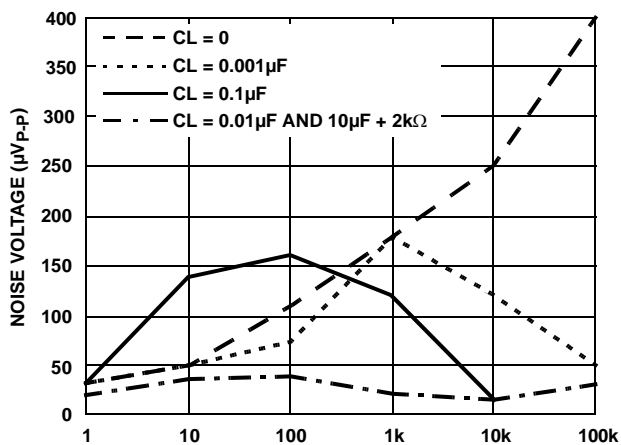

FIGURE 117. NOISE REDUCTION

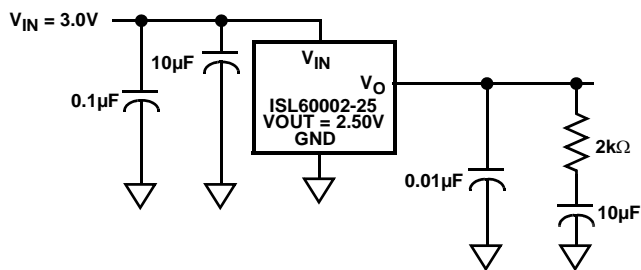

FIGURE 118.

Turn-On Time

The ISL60002 devices have ultra-low supply current and thus the time to bias up internal circuitry to final values will be longer than with higher power references. Normal turn-on time is typically 7ms. This is shown in Figure 119. Since devices can vary in supply current down to $>300nA$, turn-on time can last up to about 12ms. Care should be taken in system design to include this delay before measurements or conversions are started.

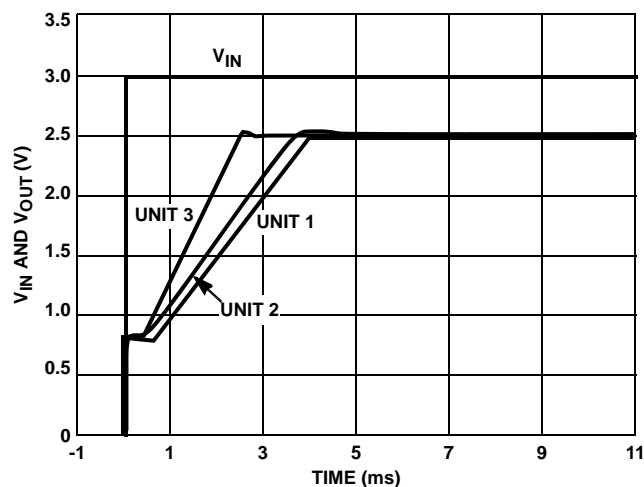
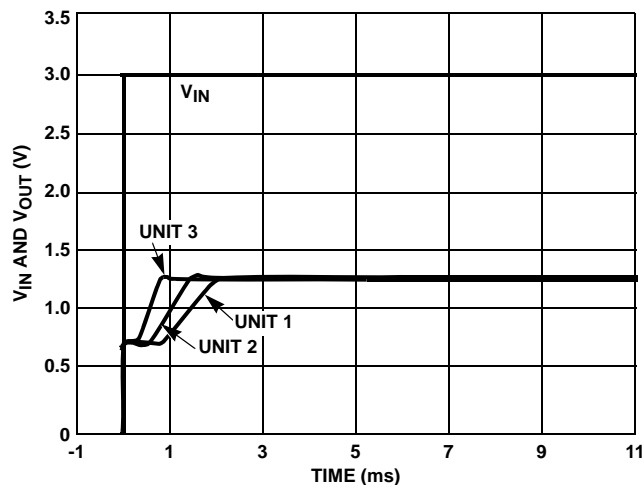

FIGURE 119. TURN-ON TIME

Temperature Coefficient

The limits stated for temperature coefficient (tempco) are governed by the method of measurement. The overwhelming standard for specifying the temperature drift of a reference is to measure the reference voltage at two temperatures, take the total variation, $(V_{HIGH} - V_{LOW})$, and divide by the temperature extremes of measurement $(T_{HIGH} - T_{LOW})$. The result is divided by the nominal reference voltage (at $T = +25^{\circ}C$) and multiplied by 10^6 to yield ppm/ $^{\circ}C$. This is the "Box" method for specifying temperature coefficient.

Typical Application Circuits

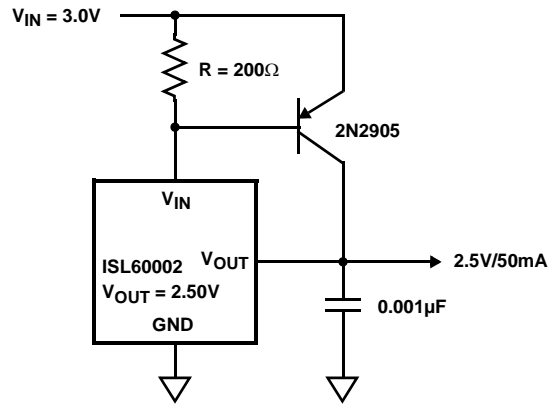

FIGURE 120. PRECISION 2.5V 50mA REFERENCE

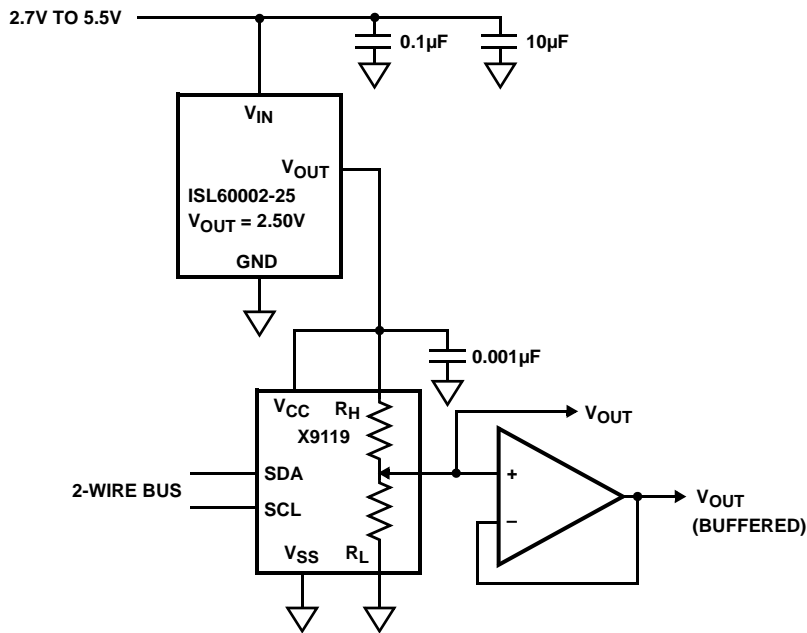

FIGURE 121. 2.5V FULL SCALE LOW-DRIFT 10-BIT ADJUSTABLE VOLTAGE SOURCE

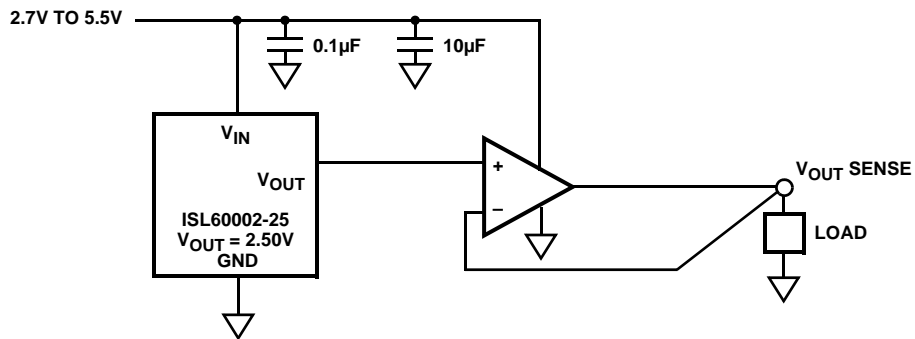
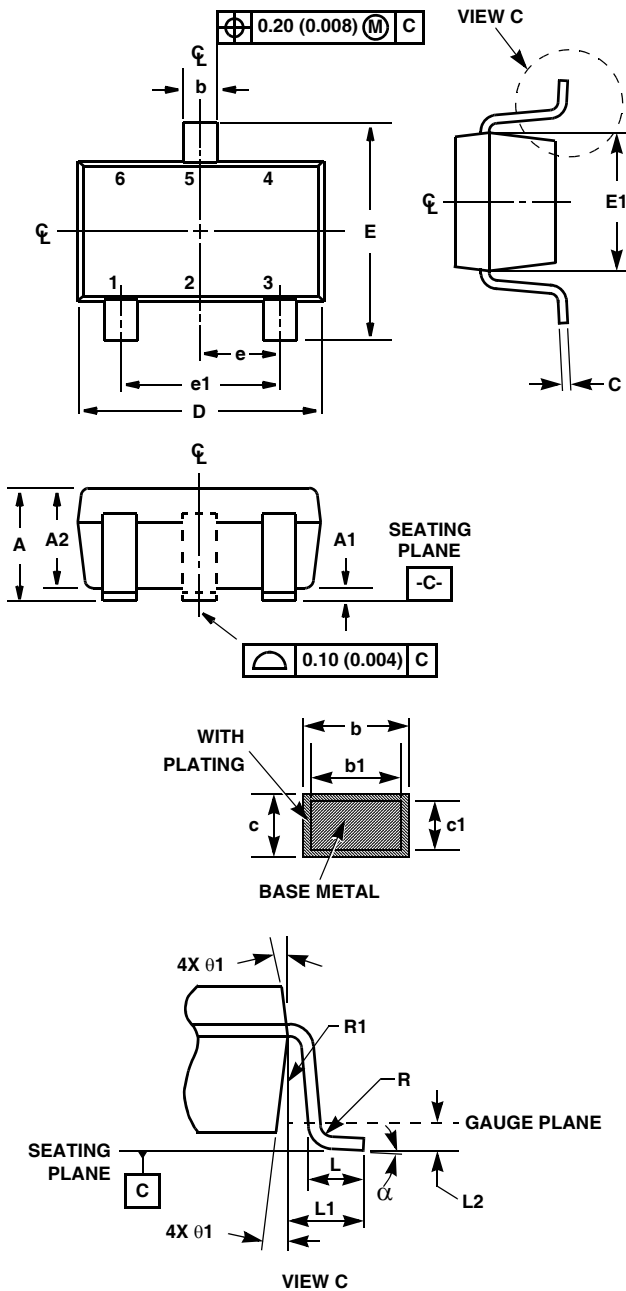

FIGURE 122. KELVIN SENSED LOAD

Small Outline Transistor Plastic Packages (SOT23-3)



P3.064

3 LEAD SMALL OUTLINE TRANSISTOR PLASTIC PACKAGE

| SYMBOL | INCHES | | MILLIMETERS | | NOTES |
|--------|------------|-------|-------------|------|-------|
| | MIN | MAX | MIN | MAX | |
| A | 0.035 | 0.044 | 0.89 | 1.12 | - |
| A1 | 0.001 | 0.004 | 0.013 | 0.10 | - |
| A2 | 0.035 | 0.037 | 0.88 | 0.94 | - |
| b | 0.015 | 0.020 | 0.37 | 0.50 | - |
| b1 | 0.012 | 0.018 | 0.30 | 0.45 | - |
| c | 0.003 | 0.007 | 0.085 | 0.18 | 6 |
| c1 | 0.003 | 0.005 | 0.08 | 0.13 | 6 |
| D | 0.110 | 0.120 | 2.80 | 3.04 | 3 |
| E | 0.083 | 0.104 | 2.10 | 2.64 | - |
| E1 | 0.047 | 0.055 | 1.20 | 1.40 | 3 |
| e | 0.0374 Ref | | 0.95 Ref | | - |
| e1 | 0.0748 Ref | | 1.90 Ref | | - |
| L | - | 0.016 | 0.21 | 0.41 | 4 |
| L1 | 0.024 Ref | | 0.60 Ref | | - |
| L2 | 0.010 Ref | | 0.25 Ref | | - |
| N | 3 | | 3 | | 5 |
| R | 0.004 | - | 0.10 | - | - |
| R1 | 0.004 | 0.010 | 0.10 | 0.25 | - |
| a | 0° | 8° | 0° | 8° | - |

Rev. 1 11/06

NOTES:

1. Dimensioning and tolerance per ASME Y14.5M-1994.
2. Package conforms to EIAJ SC-74 and JEDEC MO178AB.
3. Dimensions D and E1 are exclusive of mold flash, protrusions, or gate burrs.
4. Footlength L measured at reference to gauge plane.
5. "N" is the number of terminal positions.
6. These Dimensions apply to the flat section of the lead between 0.08mm and 0.15mm from the lead tip.
7. Controlling dimension: MILLIMETER. Converted inch dimensions are for reference only
8. Die is facing up for mold die and trim-form.

All Intersil U.S. products are manufactured, assembled and tested utilizing ISO9000 quality systems.

Intersil Corporation's quality certifications can be viewed at www.intersil.com/design/quality

Intersil products are sold by description only. Intersil Corporation reserves the right to make changes in circuit design, software and/or specifications at any time without notice. Accordingly, the reader is cautioned to verify that data sheets are current before placing orders. Information furnished by Intersil is believed to be accurate and reliable. However, no responsibility is assumed by Intersil or its subsidiaries for its use; nor for any infringements of patents or other rights of third parties which may result from its use. No license is granted by implication or otherwise under any patent or patent rights of Intersil or its subsidiaries.

For information regarding Intersil Corporation and its products, see www.intersil.com