

Silicon PNP Power Transistors

2SA1186

DESCRIPTION

- With TO-3PN package
- High current capability
- Complement to type 2SC2837

APPLICATIONS

- Audio and general purpose applications

PINNING

PIN	DESCRIPTION
1	Base
2	Collector;connected to mounting base
3	Emitter

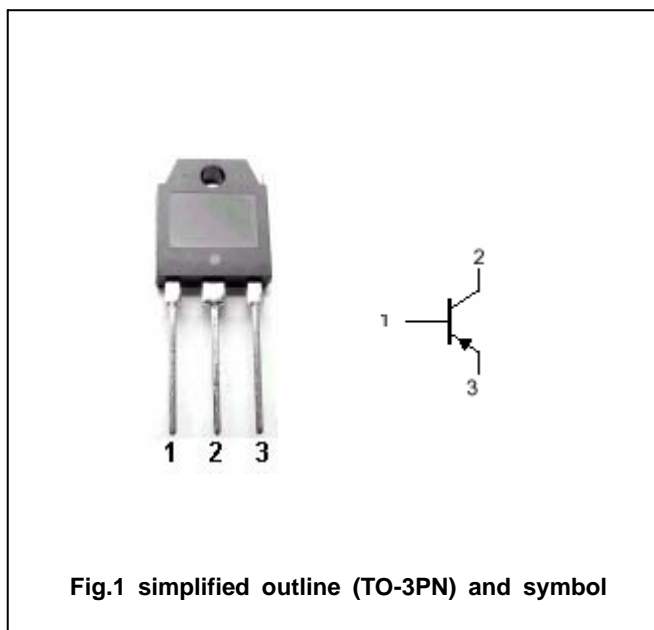

Fig.1 simplified outline (TO-3PN) and symbol

Absolute maximum ratings(Ta=)

SYMBOL	PARAMETER	CONDITIONS	VALUE	UNIT
V_{CBO}	Collector-base voltage	Open emitter	-150	V
V_{CEO}	Collector-emitter voltage	Open base	-150	V
V_{EBO}	Emitter-base voltage	Open collector	-5	V
I_C	Collector current		-10	A
I_B	Base current		-2	A
P_C	Collector power dissipation	$T_C=25$	100	W
T_j	Junction temperature		150	
T_{stg}	Storage temperature		-55~150	

Silicon PNP Power Transistors

2SA1186

CHARACTERISTICS

T_j=25 unless otherwise specified

SYMBOL	PARAMETER	CONDITIONS	MIN	TYP.	MAX	UNIT
V _{(BR)CEO}	Collector-emitter breakdown voltage	I _C =-25mA ; I _B =0	-150			V
V _{CEsat}	Collector-emitter saturation voltage	I _C =-5A; I _B =-0.5A			-2.0	V
I _{CBO}	Collector cut-off current	V _{CB} =-150V; I _E =0			-0.1	mA
I _{EBO}	Emitter cut-off current	V _{EB} =-5V; I _C =0			-0.1	mA
h _{FE}	DC current gain	I _C =-3A ; V _{CE} =-4V	50			
C _{ob}	Output capacitance	I _E =0 ; V _{CB} =-80V; f=1MHz		110		pF
f _T	Transition frequency	I _E =1A ; V _{CE} =-12V		60		MHz

Switching times

t _{on}	Turn-on time	I _C =-5A; R _L =12 I _{B1} =-I _{B2} =-0.5A V _{CC} =-60V		0.25		μs
t _s	Storage time			0.80		μs
t _f	Fall time			0.20		μs

◆ h_{FE} Classifications

O	P	Y
50-100	70-140	90-180

Silicon PNP Power Transistors

2SA1186

PACKAGE OUTLINE

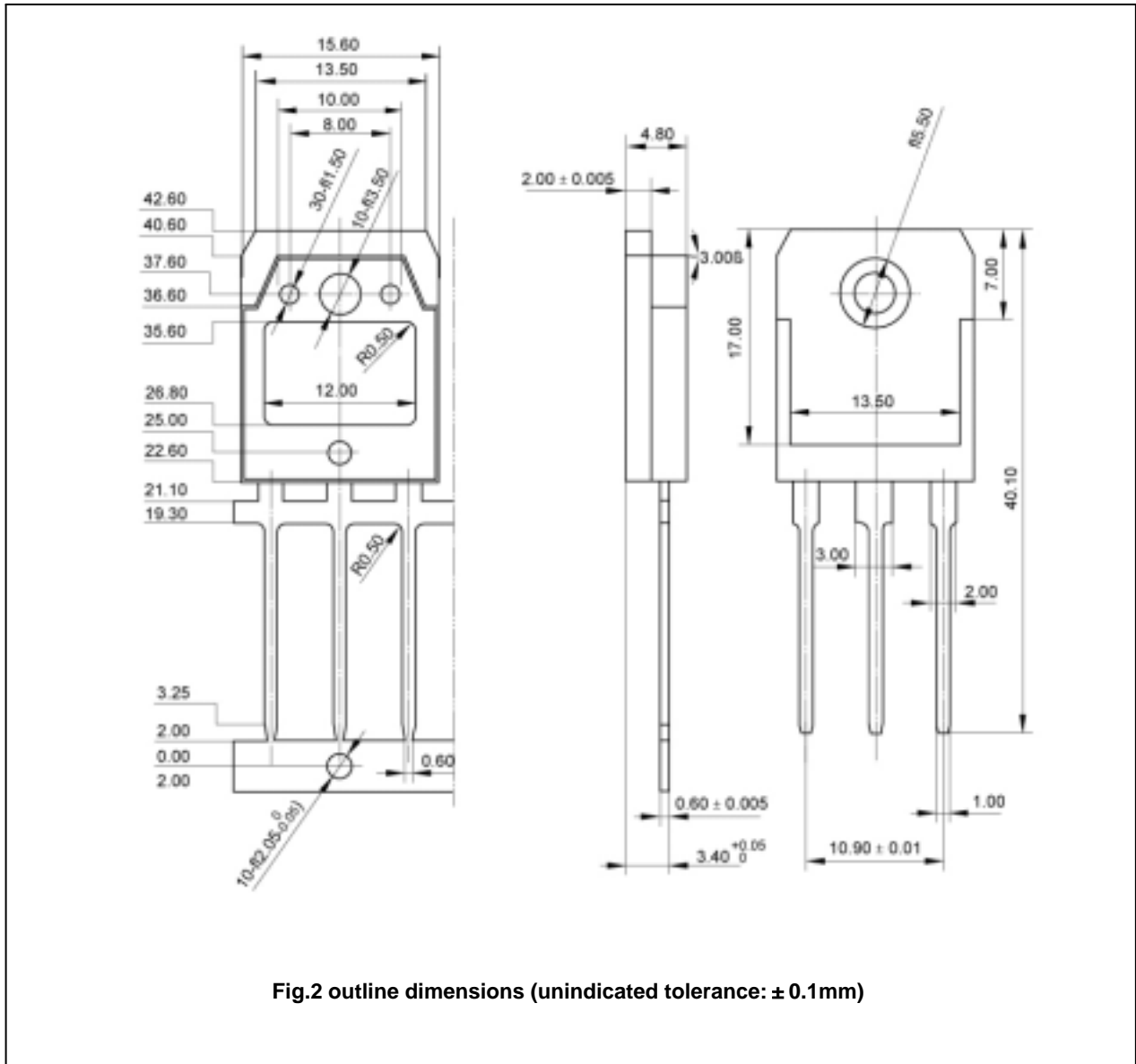

Fig.2 outline dimensions (unindicated tolerance: ± 0.1mm)

Silicon PNP Power Transistors

2SA1186

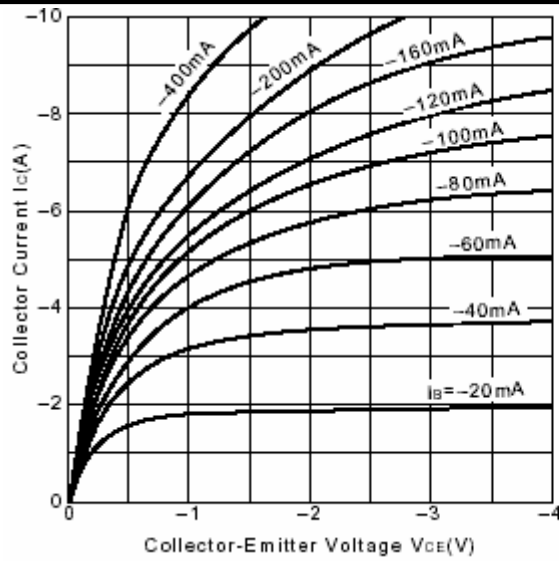

Fig.3 Static Characteristic

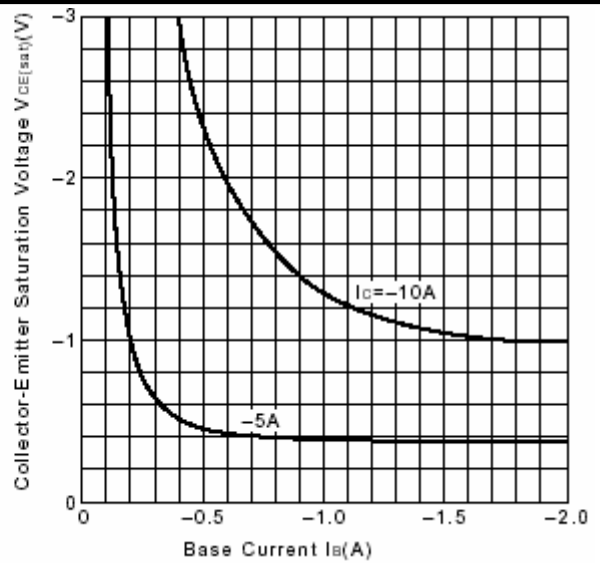

Fig.4 $V_{CE(sat)}-I_B$ Characteristics

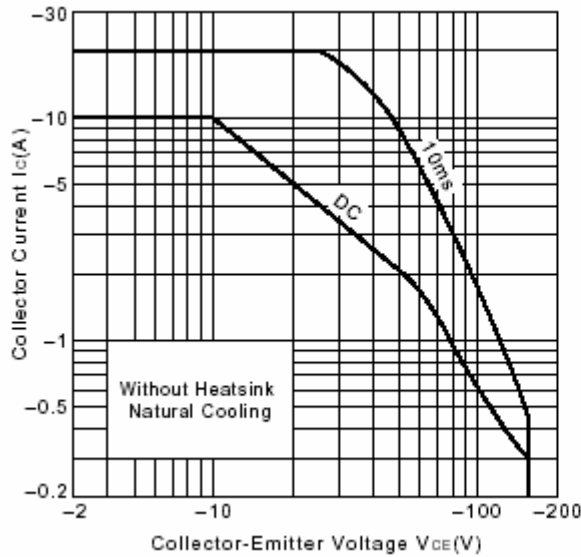

Fig.5 Safe Operating Area

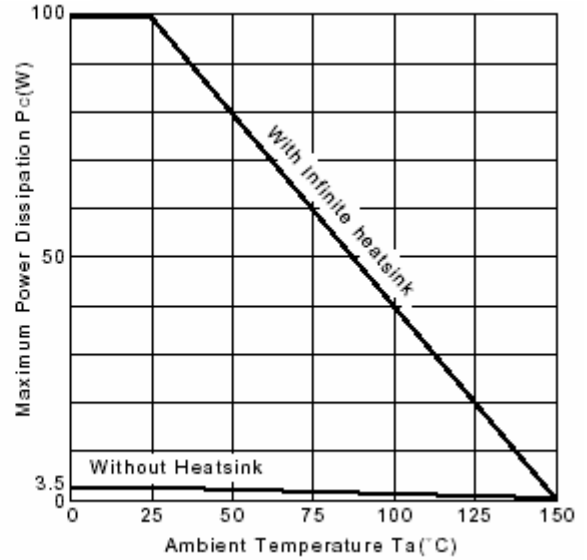

Fig.6 P_c-T_a Derating

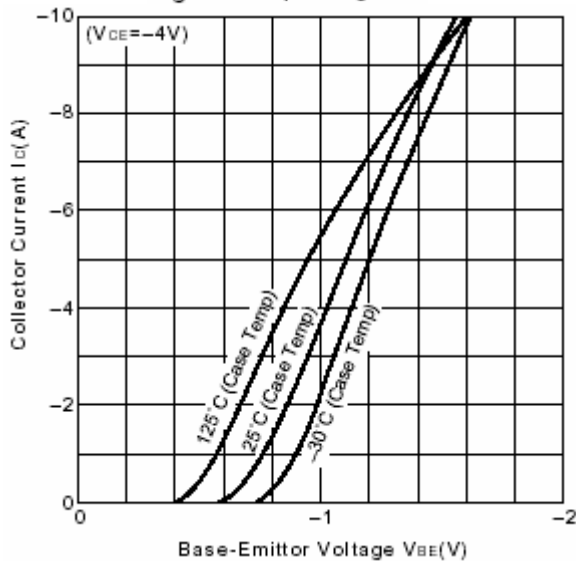

Fig.7 I_C-V_{BE}

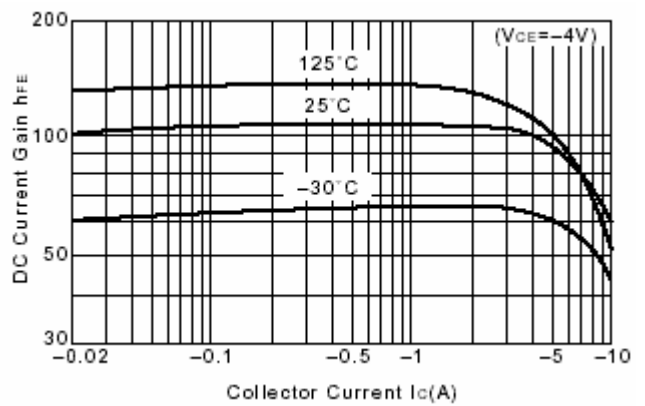

Fig.8 DC current Gain