

## Features

- For multiple applications
- Usable bandwidth 3 MHz
- Low loss
- High attenuation
- Balanced or single-ended operation
- Ceramic Surface Mount Package (SMP)
- Hermetic
- RoHS compliant (2002/95/EC), Pb-free

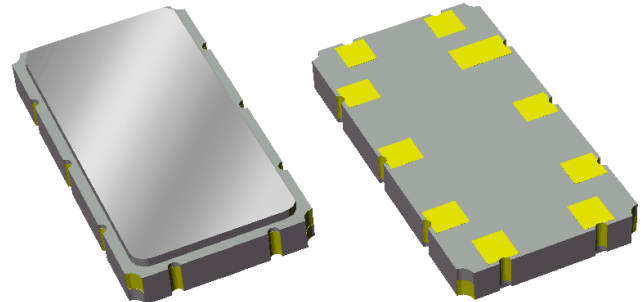

## Package

Surface Mount 9.10 x 4.80 x 1.24 mm  
SMP-35C

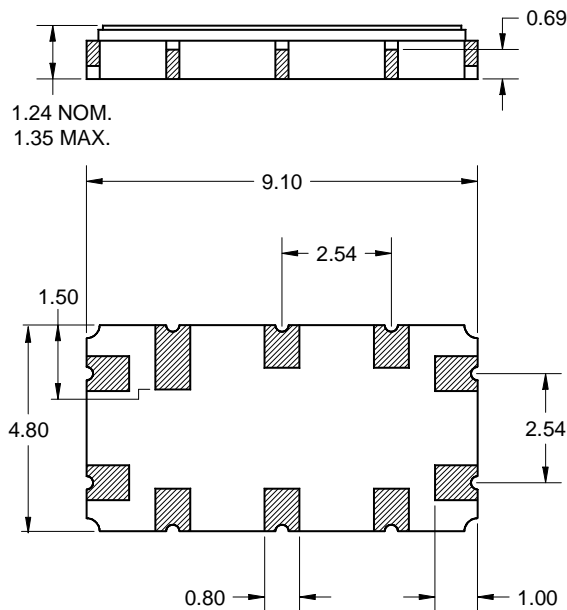

Dimensions shown are nominal in millimeters  
All tolerances are  $\pm 0.15$ mm except overall  
length and width  $\pm 0.10$ mm

Body:  $Al_2O_3$  ceramic  
Lid: Kovar, Ni plated  
Terminations: Au plating 0.5 - 1.0 $\mu$ m,  
over a 2 - 6 $\mu$ m Ni plating

## Pin Configuration

Bottom View

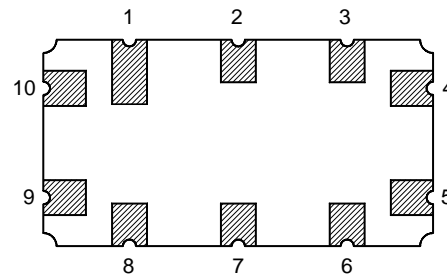

Pin No. Balanced	Description
9	Input +
10	Input -
4	Output +
5	Output -
1,2,3,6,7,8	Case Ground

Pin No. Single-Ended	Description
9	Input
10	Ground
4	Output
5	Ground
1,2,3,6,7,8	Case Ground

**Electrical Specifications <sup>(1)</sup>**

Operating Temperature Range: <sup>(2)</sup> -40 to +85 °C

Parameter <sup>(3)</sup>	Minimum	Typical <sup>(5)</sup>	Maximum	Unit
<b>Center Frequency</b>	-	140	-	MHz
<b>Minimum Insertion Loss</b>	-	13.6	16	dB
<b>Amplitude Variation</b> 138.5 – 141.5 MHz	-	0.4	1.0	dB p-p
<b>Phase Linearity</b> 138.8 – 141.2 MHz	-	2.4	4	° p-p
138.5 – 141.5 MHz	-	2.5	6	° p-p
<b>Average Group Delay</b> 138.8 – 141.2 MHz	0.91	0.96	1.01	µs
<b>Relative Attenuation <sup>(4)</sup></b>				
10 – 118 MHz	45	60	-	dB
118 – 129 MHz	40	56	-	dB
129 – 136 MHz	40	47	-	dB
From $f_o \pm 3.25$ MHz to $f_o \pm 3.35$ MHz	20	32	-	dB
From $f_o \pm 3.35$ MHz to $f_o \pm 4.0$ MHz	25	41	-	dB
144 – 157 MHz	35	46	-	dB
157 – 162 MHz	40	57	-	dB
162 – 171 MHz	40	59	-	dB
171 – 280 MHz	40	53	-	dB
<b>Triple Transit Suppression</b>	35	44	-	dB
<b>Source Impedance (balanced or single-ended) <sup>(6)</sup></b>	-	50	-	Ω
<b>Load Impedance (balanced or single-ended) <sup>(6)</sup></b>	-	50	-	Ω

**Notes:**

1. All specifications are based on the TriQuint matching schematics shown on page 4
2. In production, devices will be tested at room temperature to a guardbanded specification to ensure electrical compliance over temperature
3. Electrical margin has been built into the design to account for the variations due to temperature drift and manufacturing tolerances
4. Relative to minimum insertion loss
5. Typical values are based on average measurements at room temperature
6. This is the optimum impedance in order to achieve the performance shown

**Typical Performance (at room temperature)**

**Frequency Response**

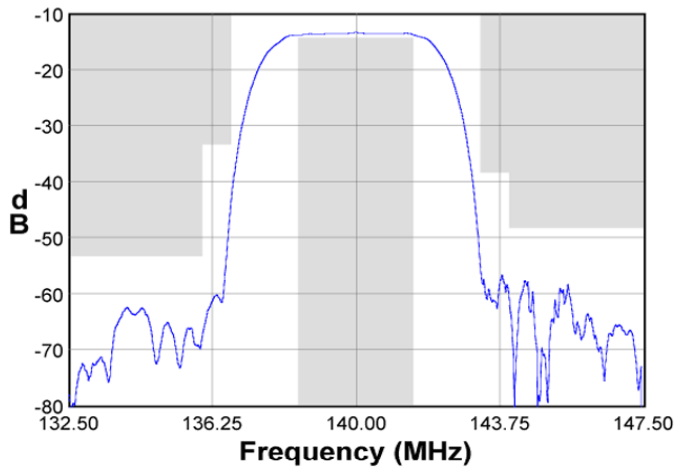

**Passband Response**

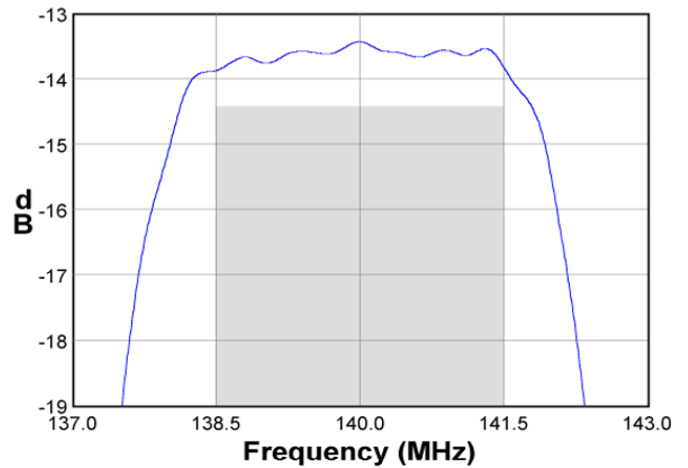

**Wideband Response**

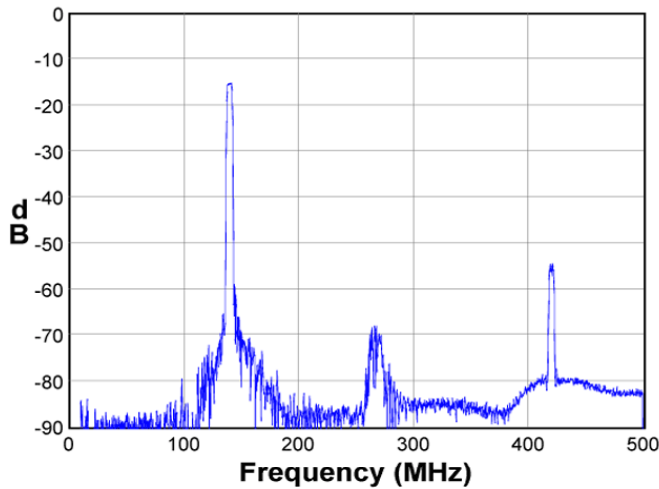

**Phase / Group Delay**

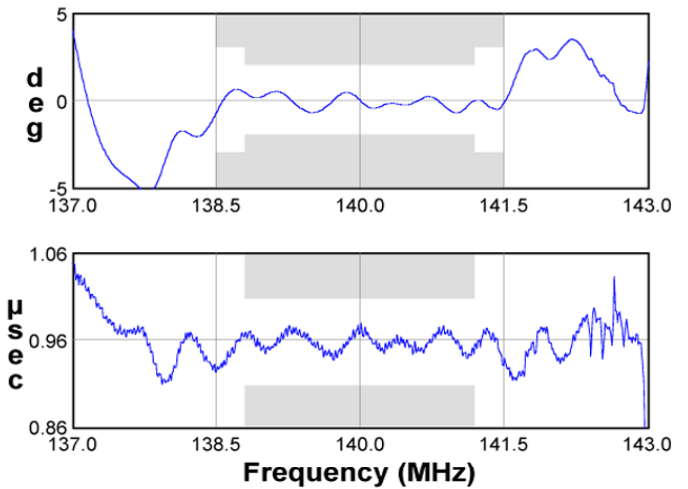

**Input Smith Chart**

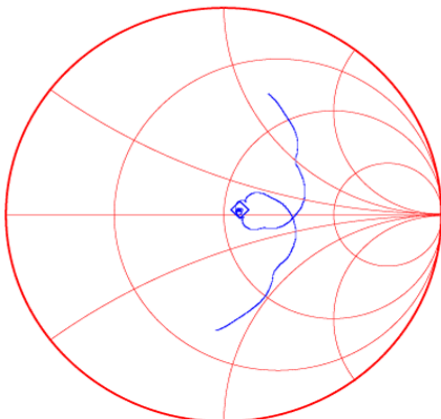

**Output Smith Chart**

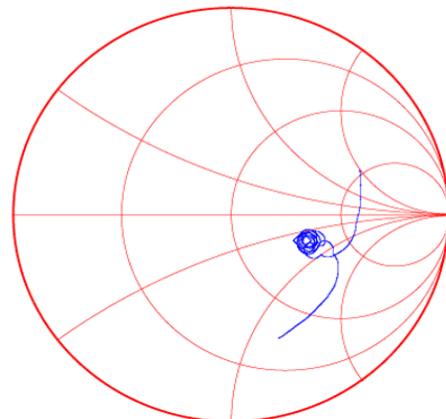

**Matching Schematics**

Actual matching values may vary due to PCB layout and parasitics

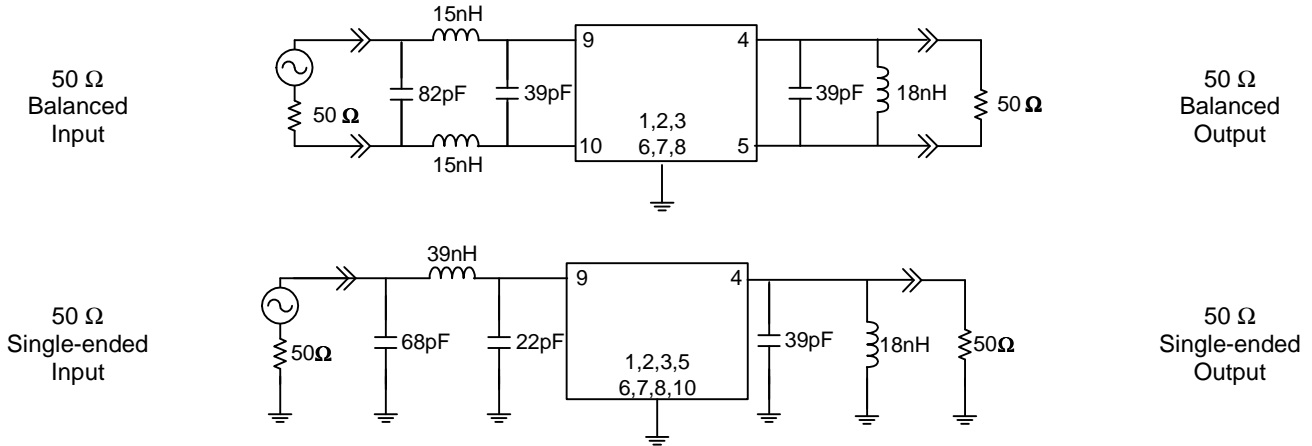

**Marking**

**PCB Footprint**

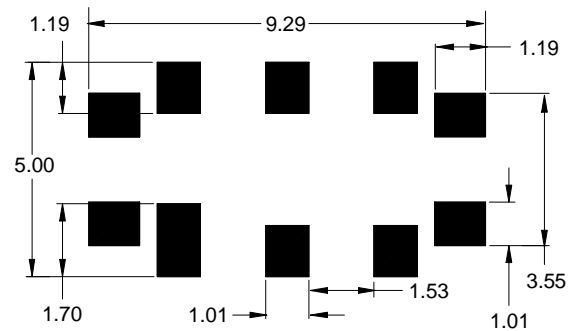
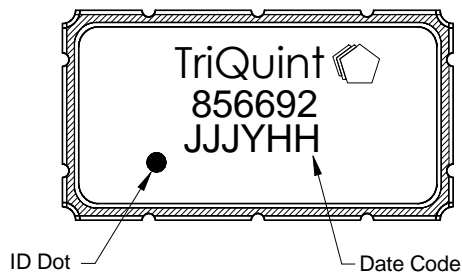

The date code consists of: day of the current year (Julian, 3 digits), last digit of the year (1 digit) and hour (2 digits)

This footprint represents a recommendation only  
Dimensions shown are nominal in millimeters

**Tape and Reel**

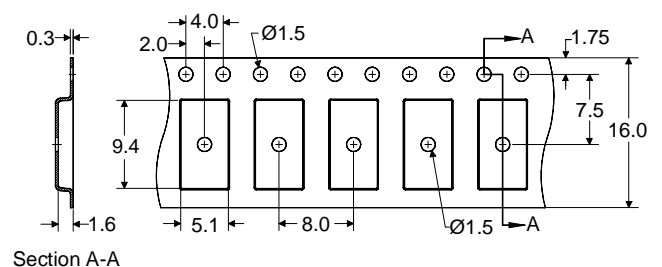
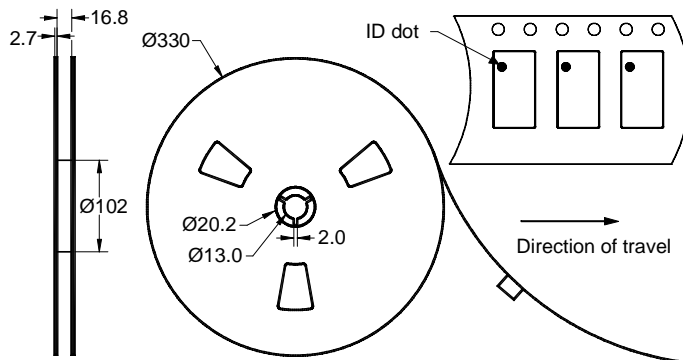

Dimensions shown are nominal in millimeters  
Packaging quantity: 4000 units/reel

### Maximum Ratings

Parameter	Symbol	Minimum	Maximum	Unit
Operating Temperature Range	T	-40	+85	°C
Storage Temperature Range	T <sub>stg</sub>	-55	+125	°C
Pyroelectric Voltage	V <sub>Pyro</sub>	-	50	mV p-p
Input Power	P <sub>in</sub>	-	+20	dBm

### Important Notes

#### Warnings

- Electrostatic Sensitive Device (ESD) 
- Avoid ultrasonic exposure

#### RoHS Compliance

- This product complies with EU directive 2002/95/EC (RoHS) 

#### Solderability

- Compatible with JEDEC J-STD-020C **Pb-free** process, **260°C** peak reflow temperature ([see soldering profile](#))

### Links to Additional Technical Information

[PCB Layout Tips](#)

[Qualification Flowchart](#)

[Soldering Profile](#)

[S-Parameters](#)

[RoHS Information](#)

[Other Technical Information](#)

TriQuint's liability is limited only to the Surface Acoustic Wave (SAW) component(s) described in this data sheet. TriQuint does not accept any liability for applications, processes, circuits or assemblies, which are implemented using any TriQuint component described in this data sheet.

### Contact Information

**TriQuint**   
SEMICONDUCTOR  
PO Box 609501  
Orlando, FL 32860-9501  
USA

Phone: +1 (407) 886-8860  
Fax: +1 (407) 886-7061  
Email: [info-product@tqs.com](mailto:info-product@tqs.com)  
Web: [www.triquint.com](http://www.triquint.com)

Or contact one of our worldwide  
Network of [sales offices](#),  
[Representatives or distributors](#)