

Single Row Terminal Blocks

A0 & CB0

Dimensions- Inches (Millimeters)

A0

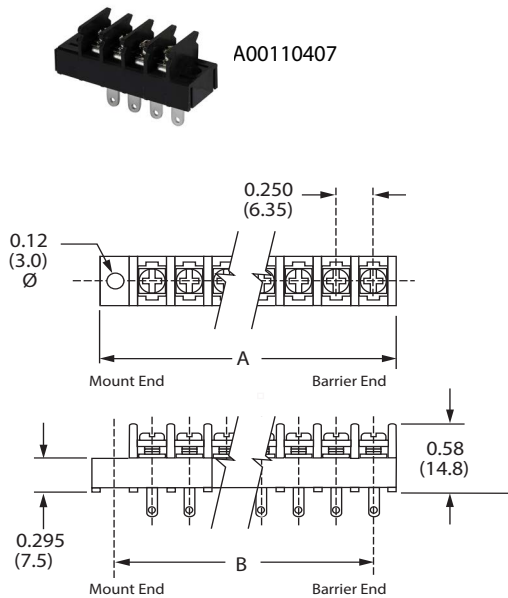

CB0

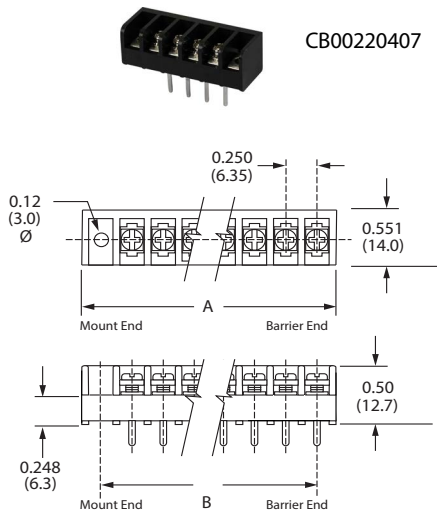

Specifications

Rating: 10 A, 300 V

Center Spacing: 0.25" (6.35 mm)

Wire Range: #16-30 AWG

Screw Size: M3.0 nickel-plated steel SEMS

Torque Rating: 10 lb-in.

Recommended PCB Hole Diameter: 1.6 mm - 1.8 mm

Operating Temperature: -40 °C to +120 °C

Body Material: Polyamide 66, UL94 V-0, Black

Terminal Material: Brass, tin plated

Breakdown Voltage: 2000 V

Agency Information: UL file E62622

Poles	MOUNTING ENDS		BARRIER ENDS	
	A Length	B Mount Centers	A Length	B End Pole Centers
02	1.04	0.79	0.54	0.25
03	1.29	1.04	0.79	0.50
04	1.54	1.29	1.04	0.75
05	1.79	1.54	1.29	1.00
06	2.04	1.79	1.54	1.25
07	2.29	2.04	1.79	1.50
08	2.54	2.29	2.04	1.75
09	2.79	2.54	2.29	2.00
10	3.04	2.79	2.54	2.25
11	3.29	3.04	2.79	2.50
12	3.54	3.29	3.04	2.75
13	3.79	3.54	3.29	3.00
14	4.04	3.79	3.54	3.25
15	4.29	4.04	3.79	3.50
16	4.54	4.29	4.04	3.75
17	4.79	4.54	4.29	4.00
18	5.04	4.79	4.54	4.25
19	5.29	5.04	4.79	4.50
20	5.54	5.29	5.04	4.75
21	5.79	5.54	5.29	5.00
22	6.04	5.79	5.54	5.25
23	6.29	6.04	5.79	5.50
24	6.54	6.29	6.04	5.75
25	6.79	6.54	6.29	6.00
26	7.04	6.79	6.54	6.25
27	7.29	7.04	6.79	6.50
28	7.54	7.29	7.04	6.75
29	7.79	7.54	7.29	7.00
30	8.04	7.79	7.54	7.25

Dimensions in inches. To convert to millimeters, multiply by 25.4.









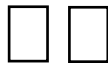

Powering Business Worldwide

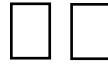
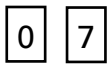
A0 & CB0

Single Row Terminal Blocks

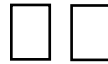
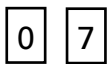
Part Numbering System

Family	Terminal Style	Base/End	Poles	Screw Options	Options
 A0 - standard barrier	 01 - handwired 02 - printed circuit	 1 - mount end 2 - barrier end	 02 to 30	 07 - steel SEMS fully seated	 C1 to C8 - 0.110" QC L1 to L6 marking options (pg 25) Covers - (pg 26)
 CB0 - closed back	 02 - printed circuit 04 - wire wrap tail	 1 - mount end 2 - barrier end	 02 to 30	 07 - steel SEMS fully seated	 C1 to C8 - 0.110" QC L1 to L6 marking options (pg 25)

Terminal Styles- Inches(Millimeters)

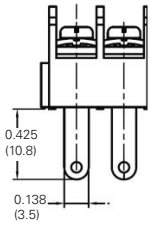

01
Handwired

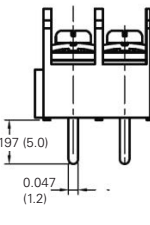
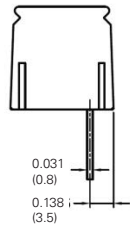

02
Circuit Board

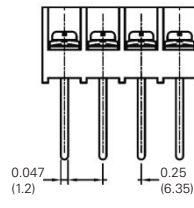
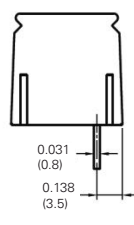

04
Wire Wrap Tail

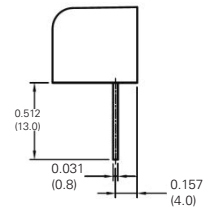

Screw Options

(Bulk ordering part numbers are in parentheses)



07
Steel SEMS nickel-plated (ACB0-SC)

Hardware Options

(Bulk ordering part numbers are in parentheses)

Jumpers

Quick Connects Blade Width 0.110" (For other orientations, contact factory)



OJ (0J12-J)

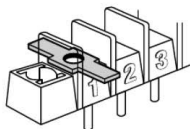

C1 (5C1-J)

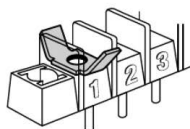

C2 (5C2-J)

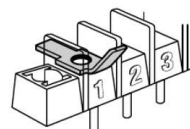

C4 (5C4-J)

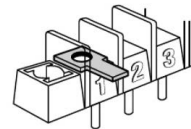

C7 (5C7-J)

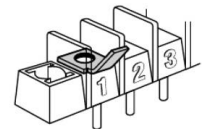

C8 (5C8-J)

Single Row Terminal Blocks

A1

Dimensions Inches (Millimeters)

A1

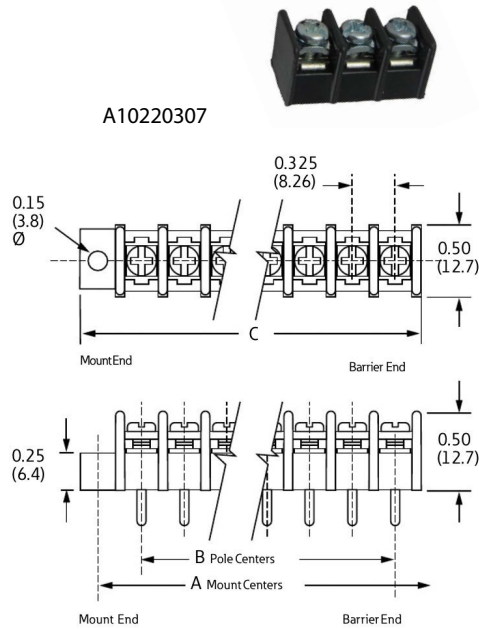

Specifications

Rating: 20A, 250V*

Center Spacing: 0.325" (8.26mm)

Wire Range: #14-22 AWG Cu

Screw Size: #6-32 zinc-plated phillslot wire-ready screws with a #2 driving recess.

Torque Rating: 9 lb-in.

Base: Standoffs are standard on CB1000 for easy flux washing.

Distance Between Barriers: 0.26" (6.6mm)

Recommended PCB Hole Diameter: 0.070" (1.78mm)

Operating Temperature: 105°C (221°F) max., -40°C (-40°F) min.

Molded Material: Black, UL Rated 94V0 Thermoplastic

Breakdown Voltage: 1600V

Agency Information: UL/CSA; IEC Compliance; CE Certified;
UL File: E62622, CSA File: 15364

* General industrial applications







Poles	MOUNTING ENDS ONLY		BARRIER & MOUNTING ENDS	BARRIER ENDS ONLY
	A Mounting Ctrs.	C Length	B Pole Ctrs.	C Length
02	0.98	1.37	0.33	0.72
03	1.30	1.69	0.65	1.04
04	1.63	2.02	0.98	1.37
05	1.95	2.34	1.30	1.69
06	2.28	2.67	1.63	2.02
07	2.60	2.99	1.95	2.34
08	2.93	3.32	2.28	2.67
09	3.25	3.64	2.60	2.99
10	3.58	3.97	2.93	3.32
11	3.90	4.29	3.25	3.64
12	4.23	4.62	3.58	3.97
13	4.55	4.94	3.90	4.29
14	4.88	5.27	4.23	4.62
15	5.20	5.59	4.55	4.94
16	5.53	5.92	4.88	5.27
17	5.85	6.24	5.20	5.59
18	6.18	6.57	5.53	5.92
19	6.50	6.89	5.85	6.24
20	6.83	7.22	6.18	6.57
21	7.15	7.54	6.50	6.89
22	7.48	7.87	6.83	7.22
23	7.80	8.19	7.15	7.54
24	8.13	8.52	7.48	7.87
25	8.45	8.84	7.80	8.19
26	8.78	9.17	8.13	8.52
27	9.10	9.49	8.45	8.84
28	9.43	9.82	8.78	9.17
29	9.75	10.14	9.10	9.49
30	10.08	10.47	9.43	9.82

Dimensions in inches. To convert to millimeters, multiply by 25.4.



Powering Business Worldwide

Part Numbering System

Family	Terminal Style	Base/End	Poles	Screw Options	Options
 A1 - standard barrier CB1 - closed back	 02 - printed circuit 04 - wire wrap 07 - extended pin	 1 - mount end 2 - barrier end	 02 to 24 A1 02 to 30 CB1	 Blank-std. screws 03 - stainless steel 07 - steel SEMS & washer (not available with hardware options)	 DR - angle mts. (A1 only-pg 5) B1 to B9 - 0.187" QC (all positions) L1 to L6 marking options (pg 25) LT1 to LT6 marking options (CB1 only-pg 25) MP & MT - mounting plates 0.150 dia (pg 5) R26 - rightangle bends (A1 only-pg 5)

Terminal Styles Inches (Millimeters)

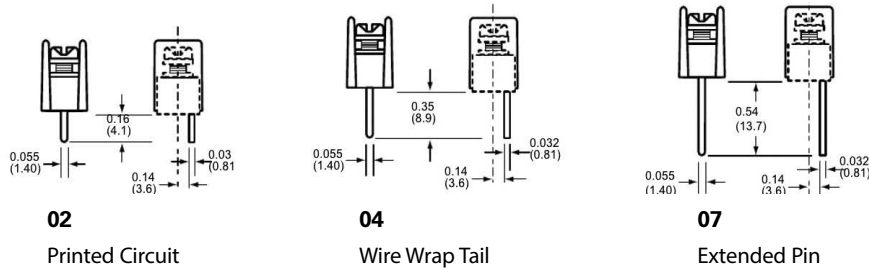

Screw Options Wire ready screws standard on all terminal styles

(Bulk ordering part numbers are in parentheses)



Standard

Zinc-Plated Steel (F508-J)



03

Stainless Steel (F510-J)



07

Zinc-Plated Steel Screws (F522-J)

Hardware Options Inches (Millimeters)

(Bulk ordering part numbers are in parentheses)

Jumpers

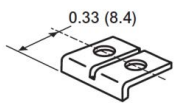

(JA1-xx-J)

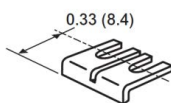

(JB1-xx-J)

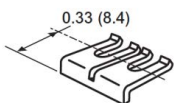

(JC1-xx-J)

Quick Connects Blade Width B = 0.187"

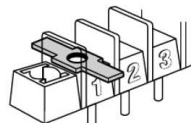

B1 (1B1-J)**



B2 (1B2-J)**

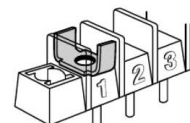

B3 (1B3-J)**

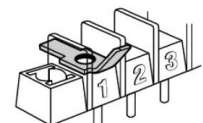

B4 (1B4-J)**

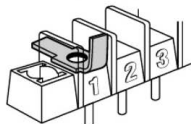

B5 (1B5-J)**

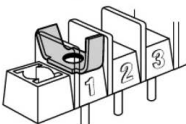

B6 (1B6-J)**

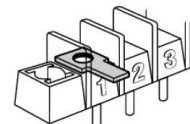

B7 (1B7-J)

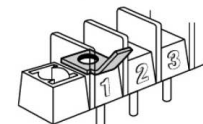

B8 (1B8-J)

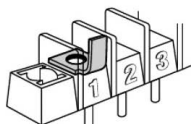

B9 (1B9-J)

** N/A on CB1

*Contact Eaton for desired configuration

Mounting Options

Right Angle Bends (A1 only)

Right angle terminals are offered on the A1. Configurations are defined in these dimensions: X = pin extension beyond the block base; Z = length from block base to centerline of the terminal tip. Standard bends consist of the X and Z dimensions shown in the chart. Specify by adding the R26 Bend Option Code to the terminal part number.

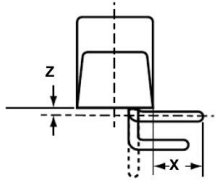

Bend Option Code	X	Z
R26 (04 terminal only)	0.14 (3.5)	0.09 (2.3)

Dimensions: in (mm)

Right Angle Bends (A1 only)

(Dimensions in inches)

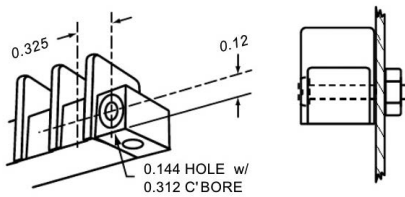

Option DR

Counterbored holes across mount ends of block enable fastening with two screws at right angles to normal mount position.

Mounting Plates

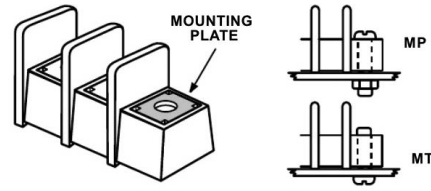

Options MP & MT

MP Metal inserts with 0.150" (3.8) dia. hole accept #6 screw.

MT Metal inserts with tapped hole accept #6-32 screw.

Bulk part numbers **1MP-J** & **1MT-J**.

Single Row Terminal Blocks

CB11

Dimensions Inches (Millimeters)

CB11



CB11720407

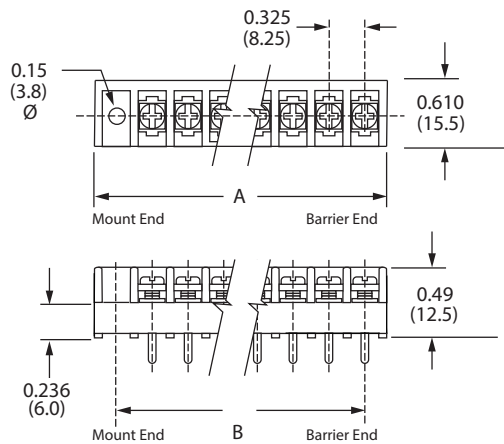

Specifications

Rating: 15 A, 300 V

Center Spacing: 0.325" (8.25 mm)

Wire Range: #14-22 AWG

Screw Size: M3.0, nickel-plated steel

Torque Rating: 12 lb-in.

Recommended PCB Hole Diameter: 1.6 mm - 1.8 mm

Operating Temperature: -40 °C to +120 °C

Body Material: Polyamide 66, UL94 V-0, Black

Terminal Material: Brass, tin plated

Breakdown Voltage: 2000 V

Agency Information: UL file E62622

Poles	MOUNTING ENDS		BARRIER ENDS	
	A Length	B Mount Centers	A Length	B End Pole Centers
02	1.35	0.65	0.70	0.32
03	1.67	0.97	1.02	0.65
04	2.00	1.30	1.35	0.97
05	2.32	1.62	1.67	1.30
06	2.65	1.95	2.00	1.62
07	2.97	2.27	2.32	1.95
08	3.30	2.60	2.65	2.27
09	3.62	2.92	2.97	2.60
10	3.94	3.25	3.30	2.92
11	4.27	3.57	3.62	3.25
12	4.59	3.90	3.94	3.57
13	4.92	4.22	4.27	3.90
14	5.24	4.55	4.59	4.22
15	5.57	4.87	4.92	4.55
16	5.89	5.20	5.24	4.87
17	6.22	5.52	5.57	5.20
18	6.54	5.85	5.89	5.52
19	6.87	6.17	6.22	5.85
20	7.19	6.50	6.54	6.17
21	7.52	6.82	6.87	6.50
22	7.84	7.15	7.19	6.82
23	8.17	7.47	7.52	7.15
24	8.49	7.80	7.84	7.47
25	8.82	8.12	8.17	7.80
26	9.14	8.44	8.49	8.12
27	9.47	8.77	8.82	8.44
28	9.79	9.09	9.14	8.77
29	10.12	9.42	9.47	9.09
30	10.44	9.74	9.79	9.42

Dimensions in inches. To convert to millimeters, multiply by 25.4.



Powering Business Worldwide

Part Numbering System

Family



CB1 - closed back

Terminal Style



12 - printed circuit

17 - extended pin

Base/End



1 - mount end

2 - barrier end

Poles



02 to 30

Screw Options



03 - stainless steel

07 - steel SEMS

Options



B1 to B9 - 0.187" QC

L1 to L6 - marking options (pg 25)

LT1 to LT6 - marking options (pg 25)

Terminal Styles- Inches(Millimeters)

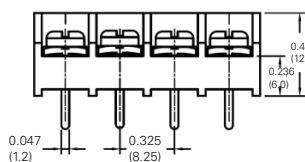

12

Printed Circuit

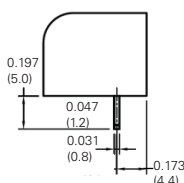

17

Extended Pin

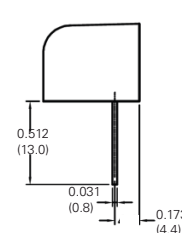
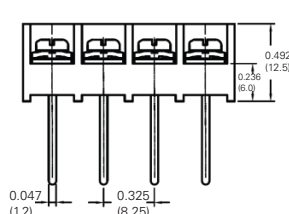

Screw Options

(Bulk ordering part numbers are in parentheses)



03

Stainless steel
(CB1-SSSC)



07

Steel SEMS Nickel-plated
(CB1-STSC)

Hardware Options

(Bulk ordering part numbers are in parentheses)

Jumpers

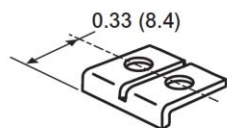

(JA1-xx-J)

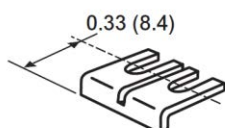

(JB1-xx-J)

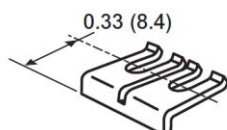

(JC1-xx-J)

Quick Connects Blade Width B = 0.187". (For other orientations, contact factory.)

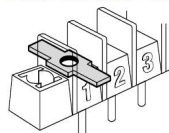

B1 (1B1-J)

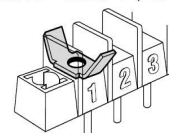

B2 (1B2-J)

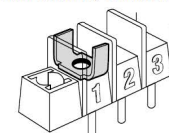

B3 (1B3-J)

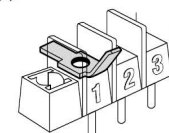

B4 (1B4-J)

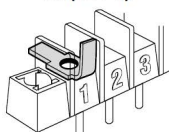

B5 (1B5-J)

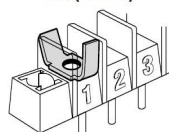

B6 (1B6-J)



B7 (1B7-J)



B8 (1B8-J)

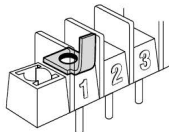

B9 (1B9-J)

Single Row Terminal Blocks

A2, LP2 & CB2

Dimensions Inches (Millimeters)

A2 & LP2

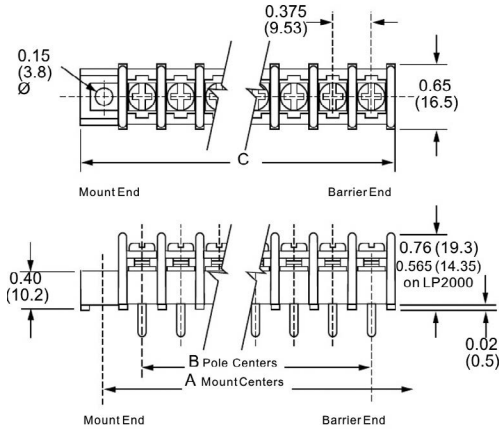

CB2

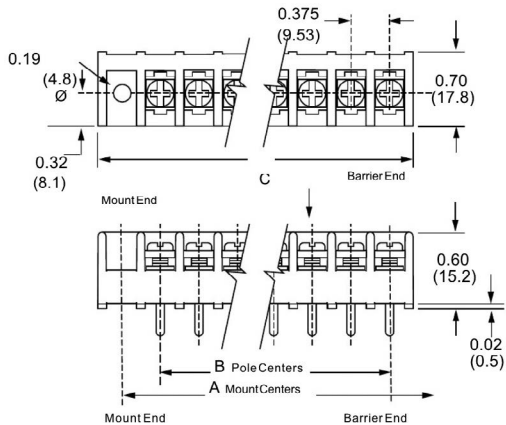

Specifications

Rating: A2: 30A, 300V* LP2: 30A, 150V* CB2: 30A, 300V*

Center Spacing: 0.375" or 3/8" (9.52mm)

Wire Range: #12-22 AWG Cu

Screw Size: #6-32 zinc-plated phillslot

Torque Rating: 9 lb-in.

Base: Standoffs standard for easy flux washing

Distance Between Barriers: 0.32" (8.1mm)

Recommended PCB Hole Diameter: 0.076" (1.93mm)

Operating Temperature: 105°C (221°F) max., -40°C (-40°F) min.

Molded Material: Black, UL Rated 94V0 Thermoplastic

Breakdown Voltage: 3400V (A2 & LP2); 4100V (CB2).

Agency Information: UL File E62622, CSA File 47235; IEC Compliance; CE Certified

* 30A Rating achieved with a #10 copper wire crimped to a ring terminal.; 20A Rating without ring terminal.

Poles	MOUNTING ENDS ONLY		BARRIER & MOUNTING ENDS	
	A Mounting Ctrs.	C Length	B Pole Ctrs.	C Length
02	1.13	1.56	0.38	0.81
03	1.50	1.93	0.75	1.18
04	1.88	2.30	1.13	1.56
05	2.25	2.68	1.50	1.93
06	2.63	3.06	1.88	2.31
07	3.00	3.43	2.25	2.68
08	3.38	3.81	2.63	3.06
09	3.75	4.18	3.00	3.43
10	4.13	4.56	3.38	3.81
11	4.50	4.93	3.75	4.18
12	4.88	5.31	4.13	4.56
13	5.25	5.69	4.50	4.93
14	5.63	6.06	4.88	5.31
15	6.00	6.43	5.25	5.68
16	6.38	6.81	5.63	6.06
17	6.75	7.18	6.00	6.43
18	7.13	7.56	6.38	6.81
19	7.50	7.93	6.75	7.18
20	7.88	8.31	7.13	7.56
21	8.25	8.68	1.50	7.93
22	8.63	9.06	7.88	8.31
23	9.00	9.43	8.25	8.68
24	9.38	9.81	8.63	9.06
25	-	-	9.00	9.43
26	-	-	9.38	9.81



Powering Business Worldwide

Part Numbering System

Family



A2 - standard barrier

LP2 - low profile barrier

Terminal Style



01* - handwired

02 - printed circuit

03 - non feed-thru

04 - wire wrap tail

06 - handwired

07 - extended pin

08 - printed circuit

09 - 0.250" QC short

10 - 0.187" QC

14 - printed circuit

19 - 0.250" QC long

Base/End



1 - std. base/
mnt. end

2 - std. base/
barrier end on
mount

3 - insulator
base/mnt. end

4 - insulator
base/barrier end

5 - closed base/
mount end

6 - closed base/
molded mount
end

Base/End
Note: 5 & 6
Styles only
available with 03
terminals.

Poles

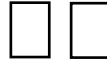

02 to 26 Barrier end

02 to 24 Mount end

Screw Options

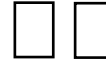

Blank-std. screws

00 - screws shipped
bulk

03* - stainless steel

04 - brass nickel-plated

07 - steel SEMS***

09* - brass SEMS
nickel-plated***

CA** - captive screw

WR* - wire ready

Options

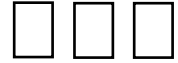

AB* - angle mnt. options (pg 11)

A1 to A9 - 0.250" QC

B1 to B9 - 0.187" QC

DR* - drilled right angle
(pg 11)

L1 to L6 marking options
(pg 25)

MP* mounting plates (pg 11)

R30 to R75 - right angle
bends (pg 11)

S1* - solder lug/flat

Covers - (pg 26)

* A2 only.

** Not compatible with 03-stainless steel screws.

*** SEMS screws not available with hardware options

Terminal Styles Inches (Millimeters)

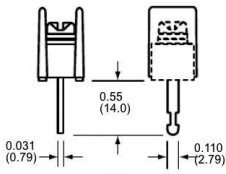

01
Handwired

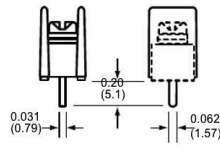

02
Printed Circuit



03
Non Feed-Thru

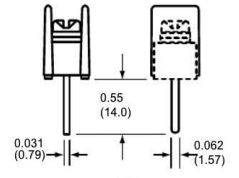

04
Wire Wrap Tail

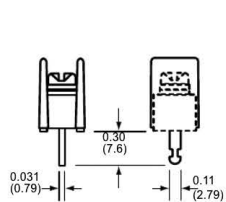

06
Handwired

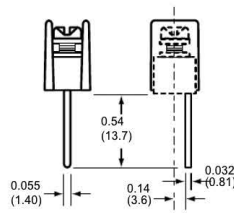

07
Extended Pin

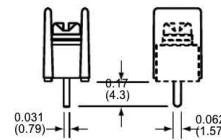

08
Printed Circuit

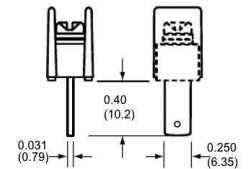

09
0.250" QC short

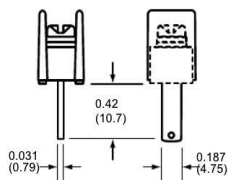

10
0.187" QC

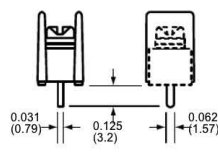

14
Printed Circuit

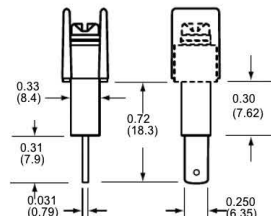

19
0.250" QC long

Screw Options

(Bulk ordering part numbers are in parentheses)



Standard
Zinc-plated Steel
(F505-J)



03
Stainless Steel
(F507-J)



04
Brass
Nickel-Plated
(F506-J)



07
Steel SEMS
(F523-J)



09
Brass SEMS
Nickel-Plated
(F524-J)



WR
Wire Ready

Hardware Options Inches (Millimeters)

(Bulk ordering part numbers are in parentheses)

Solder Lugs

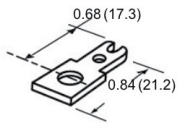

S1
(2S1-J)

Jumpers

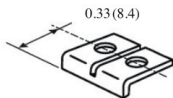

(JA2-xx-J)

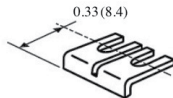

(JB2-xx-J)

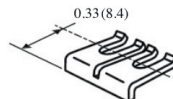

(JC2-xx-J)



†OJ2
(OJ2-J)



†OJ4
(OJ4-J)

Quick Connects

Blade Width A = 0.250" Blade Width B = 0.187"

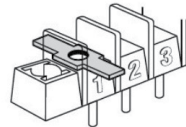

A1 & B1
(2A1-J & 2B1-J)

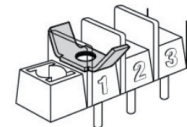

A2 & B2
(2A2-J & 2B2-J)

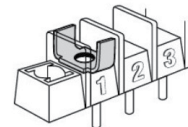

A3 & B3
(2A3-J & 2B3-J)

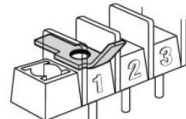

A4 & B4
(2A4-J & 2B4-J)



A5 & B5
(2A5-J & 2B5-J)

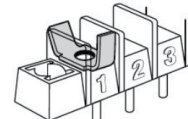

A6 & B6
(2A6-J & 2B6-J)

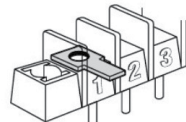

A7 & B7
(2A7-J & 2B7-J)

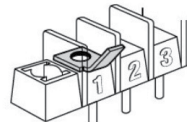

A8 & B8
(2A8-J & 2B8-J)

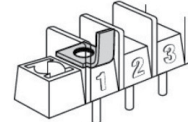

A9 & B9
(2A9-J & 2B9-J)

† Contact Eaton for desired configuration.

Base/End Options Inches (Millimeters)



1 - Standard base/mount end



2 - Standard base/barrier end



3 - Insulator base/mount end

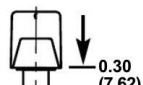

4 - Insulator base/barrier end

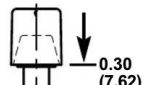

5 - Closed base/mount end



6 - Closed base/molded mount end

(not available with covers)

Mount End Details

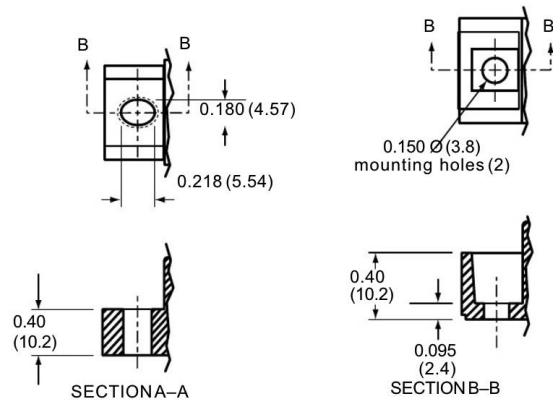

6
Molded Mount End

1, 3 & 5
Mount End

Note: On 1, 3 and 5 bases, Eaton may drill a terminal spacing to be a mount end. There will be no fit/form/function effect of mounting the product

Mounting Options Inches (Millimeters)

Right Angle Bends

Right angle terminals are offered on the A2 & LP2. Configurations are defined in these dimensions: X = pin extension beyond the block base; Z = length from block base to centerline of the terminal tip. Standard bends consist of the X and Z dimensions shown in the chart. Specify by adding the selected Bend Option Code to the terminal part number.

04 Terminal Bend Configurations

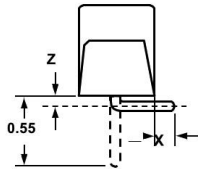

Bend Option Code	X (minimum)	Z	Available with insulator base
R35	0.01	0.23	No
R42	0.08	0.16	No
R46	0.12	0.12	No
R50	0.16	0.08	No

Dimensions in inches. To convert to millimeters, multiply by 25.4.

Angle Brackets

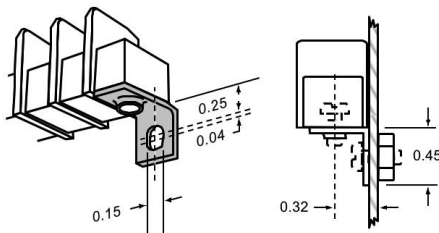

Option AB

Angle brackets enable block to be fastened at right angles to normal mount position. Bulk part number **2AB-J**.

Mounting Plates

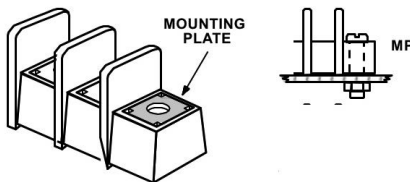

Options MP

MP Metal inserts with 0.150" dia. hole accept #6 screw.
Bulk part number **2MP-J**.

07 Terminal Bend Configurations

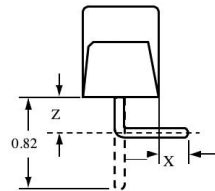

Bend Option Code	X (minimum)	Z	Available with insulator base
R35	0.01	0.50	Yes
R42	0.08	0.43	Yes
R46	0.12	0.39	Yes
R50	0.16	0.35	No
R53	0.19	0.32	No
R66	0.32	0.19	No
R75	0.41	0.10	No

Dimensions in inches. To convert to millimeters, multiply by 25.4.

Drilled Right Angle

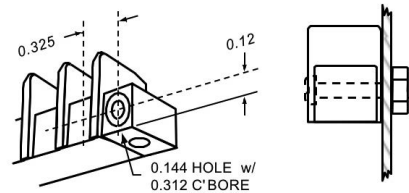

Option DR

Counterbored holes across mount ends of block enable fastening with two screws at right angles to normal mount position.

Part Numbering System

Family	Terminal Style	Base/End	Poles	Screw Options	Options
<div style="display: flex; gap: 5px;"> <div style="border: 1px solid black; padding: 2px 5px;">C</div> <div style="border: 1px solid black; padding: 2px 5px;">B</div> <div style="border: 1px solid black; padding: 2px 5px;">2</div> </div> <p>CB2 - closed back</p>	<div style="display: flex; gap: 10px;"> <div style="border: 1px solid black; width: 20px; height: 20px;"></div> <div style="border: 1px solid black; width: 20px; height: 20px;"></div> </div> <p>01 - handwired 02 - printed circuit 07 - extended pin 14 - printed circuit</p>	<div style="border: 1px solid black; width: 20px; height: 20px;"></div> <p>1 - mount end 2 - barrier end</p>	<div style="display: flex; gap: 10px;"> <div style="border: 1px solid black; width: 20px; height: 20px;"></div> <div style="border: 1px solid black; width: 20px; height: 20px;"></div> </div> <p>02 to 26 on barrier end 02 to 24 on mount end</p>	<div style="display: flex; gap: 10px;"> <div style="border: 1px solid black; width: 20px; height: 20px;"></div> <div style="border: 1px solid black; width: 20px; height: 20px;"></div> </div> <p>Blank-std. screws 07 - steel SEMS standard 09 - brass SEMS nickel-plated</p>	<div style="display: flex; gap: 10px;"> <div style="border: 1px solid black; width: 20px; height: 20px;"></div> <div style="border: 1px solid black; width: 20px; height: 20px;"></div> <div style="border: 1px solid black; width: 20px; height: 20px;"></div> </div> <p>AB - angle mounting brackets (pg 13) A7 to A9 - 0.250" QC B7 to B9 - 0.187" QC EB - exit back terminals EF - exit front terminals L1 to L6 marking options (pg 25) LT1 to LT6 marking options (pg 25) MP mtg. plates (pg 13) Covers - (pg 26)</p>

Terminal Styles Inches (Millimeters)

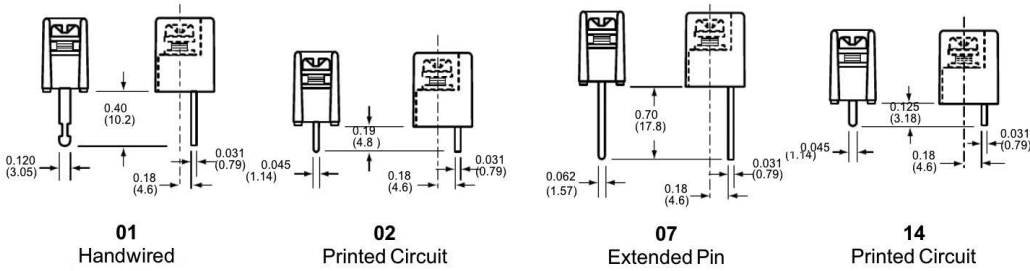

Screw Options

(Bulk ordering part numbers are in parentheses)



07
Steel SEMS
zinc-plated
(B001-7084-J)



09
Brass SEMS
nickel-plated
(F524-J)

* NOTE: Wire ready screws standard on all terminal styles.

CB2 Terminal Exit Options Inches (Millimeters)

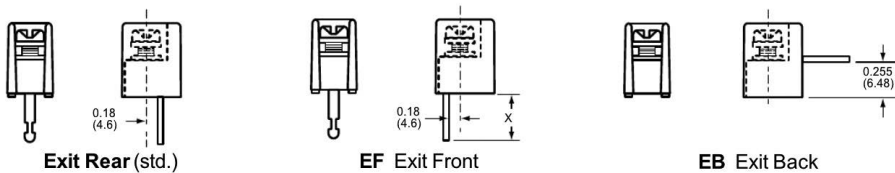

Hardware Options Inches (Millimeters)

(Bulk ordering part numbers are in parentheses)

Jumpers

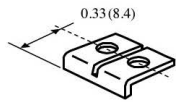

†JA
(JA2-XX-J)



†OJ2
(OJ2-J)

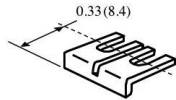

†JB
(JB2-XX-J)



†OJ4
(OJ4-J)

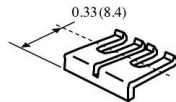

†JC
(JC2-XX-J)

† Contact Eaton for desired configuration.

Quick Connects

Blade Width A = 0.250". Blade Width B = 0.187".



A7 & B7
(2A7-J & 2B7-J)



A8 & B8
(2A8-J & 2B8-J)

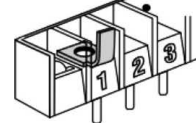

A9 & B9
(2A9-J & 2B9-J)

Mounting Options Inches (Millimeters)

Right Angle Mounting Bracket

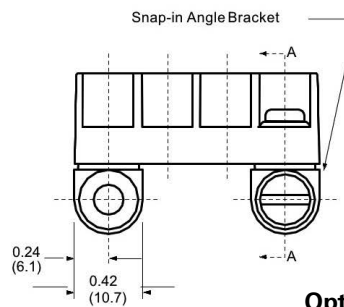
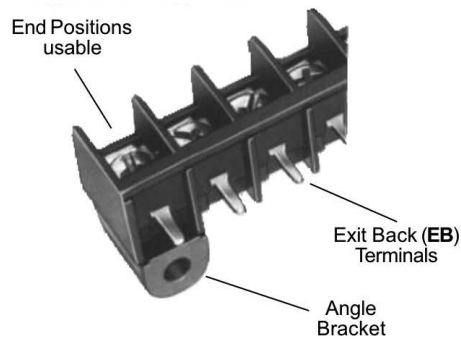

Option AB

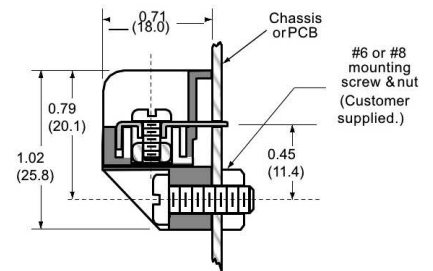

Mounts blocks on PC boards at a right angle.

- Protects solder joints.
- Bracket snaps securely on block (no hardware required).
- Minimum strip length (end positions are usable).
- Mount with #6-32 or #8-32 screws (not supplied).
- Available on 3 pole configurations and greater

Mounting Plates

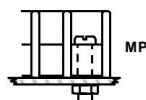
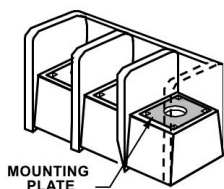

Option MP

MP Metal inserts with 0.150" dia. hole accept #6 screw.

Bulk part number 2MP-J.

Single Row Terminal Blocks

A3, LP3 & CB3

Dimensions Inches (Millimeters)

A3 & LP3



A31930307

LP307102

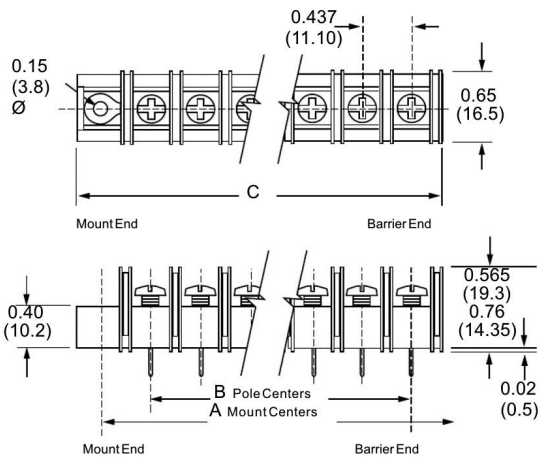

CB3

CB35110407MP

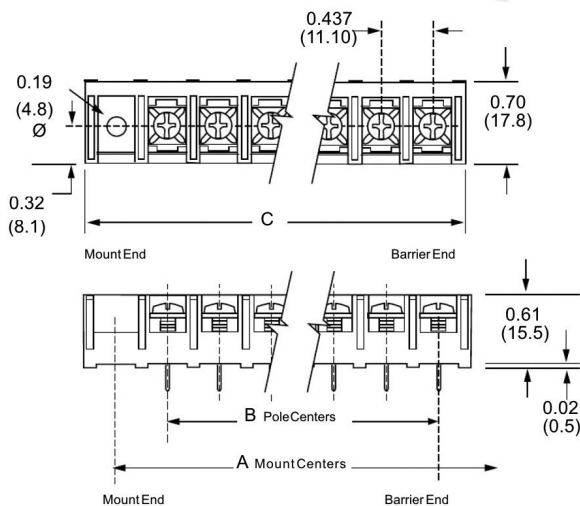

Specifications

Rating: A3: 30A, 600V* LP3: 30A, 150V* CB3: 30A, 600V*

Wire Range: #12-22 AWG Cu

Center Spacing: 0.437" or 7/16" (11.10mm)

Screw Size: #6-32 zinc-plated phillslot screws.

Torque Rating: 9 lb-in.

Base: Standoffs standard for easy flux washing.

Distance Between Barriers: 0.32" (8.1mm)

Recommended PCB Hole Diameter: 0.076" (1.93mm)

Operating Temperature: 105°C (221°F) max., -40°C (-40°F) min.

Molded Material: Black, UL Rated 94V0 Thermoplastic

Breakdown Voltage: 3500V (A3 & LP3); 8200V (CB3)

Agency Information: UL File E62622, CSA 47235; IEC Compliance, CE Certified

* 30A Rating achieved with a #10 copper wire crimped to a ring terminal; 20 Rating without ring terminal.

Poles	MOUNTING ENDS ONLY		BARRIER & MOUNTING ENDS	
	A Mounting Ctrs.	C Length	B Pole Ctrs.	C Length
02	1.31	1.73	0.43	0.98
03	1.75	2.17	0.87	1.43
04	2.18	2.61	1.31	1.87
05	2.62	3.05	1.75	2.31
06	3.06	3.48	2.18	2.75
07	3.50	3.92	2.62	3.18
08	3.93	4.36	3.06	3.62
09	4.37	4.80	3.50	4.06
10	4.81	5.23	3.93	4.50
11	5.25	5.67	4.37	4.93
12	5.68	6.11	4.81	5.37
13	6.12	6.55	5.25	5.81
14	6.56	6.98	5.68	6.25
15	7.00	7.42	6.12	6.68
16	7.43	7.86	6.56	7.12
17	7.87	8.30	7.00	7.56
18	8.31	8.73	7.43	8.00
19	8.75	9.17	7.87	8.43
20	9.18	9.60	8.31	8.87
21	9.62	10.05	8.50	9.31
22	10.06	10.48	9.18	9.75
23	10.50	10.92	9.62	10.18
24	10.93	11.36	10.06	10.62
25	11.37	11.80	10.50	11.06
26	11.81	12.23	10.98	11.50
27	-	-	11.81	12.37
28	-	-	11.37	11.07



Powering Business Worldwide

Part Numbering System

Family	Terminal Style	Base/End	Poles	Screw Options	Options
A 3					
A3 - standard barrier	01 - handwired 02 - printed circuit 03 - non feed-thru 04 - wire wrap tail 05 - extended handwired 07 - extended pin 09 - 0.250 QC short 10 - 0.187 QC 19 - 0.250 QC long	1 - std. base/mount end 2 - std. base/barrier 3* - insulator base/mount end 4* - insulator base/barrier end 5** - closed base/mount end	02 to 28 barrier end 02 to 26 mount end	Blank-std. screws 03 - stainless steel 04 - brass nickel-plated 07 - steel SEMS zinc-plated*** 09 - brass SEMS nickel-plated*** 07WR - steel SEMS wire ready CA† - captive screw	AB - angle mnt. options (pg 18) A1 to A9 - 0.250" QC B1 to B9 - 0.187" QC L1 to L6 marking options (pg 25) MP, MT - mounting plates (pg 18) RC - retaining clips (pg 18) R30 to R66 - right angle bends (pg 18)

* Base/End Styles 3 and 4 not available with 02, 03, and 09 terminals.

** Base/End Note: 5 Style only available with 03 terminals.

*** SEMS screws not available with hardware options

† Not compatible with 03 stainless steel screw option.

Terminal Styles Inches (Millimeters)

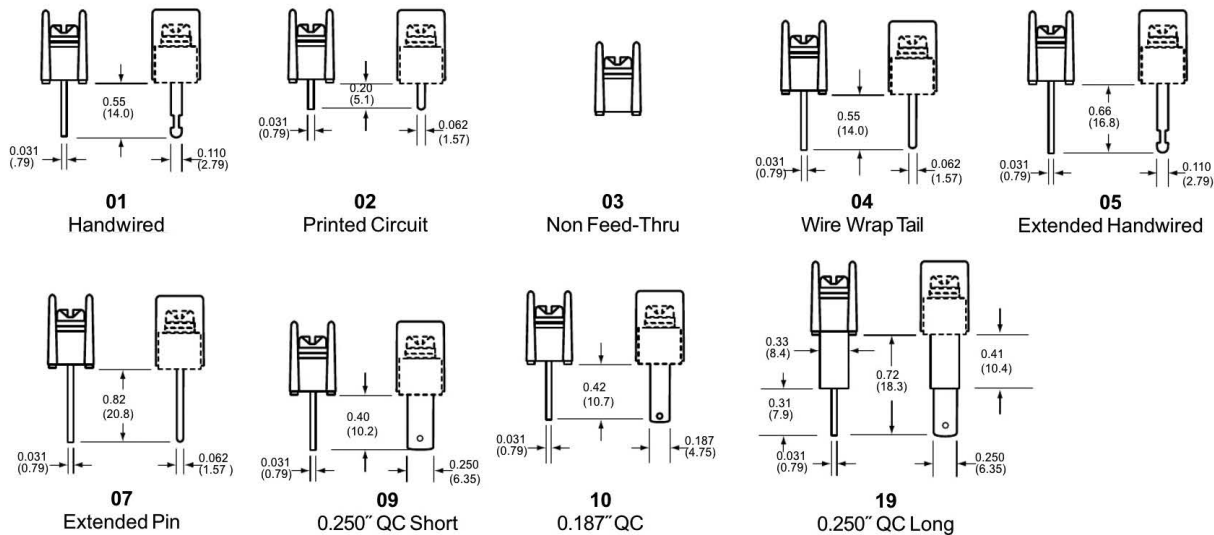



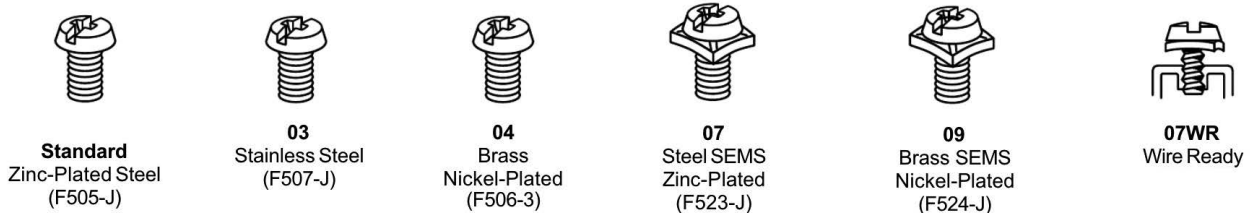

Screw Options

(Bulk ordering part numbers are in parentheses)

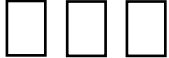

Part Numbering System

Family	Terminal Style	Base/End	Poles	Screw Options	Options
 <p>LP3 - low profile barrier</p>	 <p>01 - handwired 02 - printed circuit 03 - non feed-thru 04 - wire wrap tail 05 - extended handwired 07 - extended pin</p>	 <p>1 - std. base/ mount end 2 - std. base/ barrier 3* - insulator base/mount end 4* - insulator base/barrier end 5** - closed base/mount end</p>	 <p>02 to 28 barrier end 02 to 26 on mount end</p>	 <p>Blank-std. screws 00 - screws shipped 04 - brass nickel-plated 07 - steel SEMS zinc- plated*** CA - captive screw</p>	 <p>A1 to A9 - 0.250" QC B1 to B9 - 0.187" QC L1 to L6 marking options (pg 25) MP - mounting plates (pg 18) R30 to R66 - right angle bends (pg 18)</p>

* A2 only.
 ** Not compatible with 03-stainless steel screws.
 *** SEMS screws not available with hardware options

Terminal Styles Inches (Millimeters)

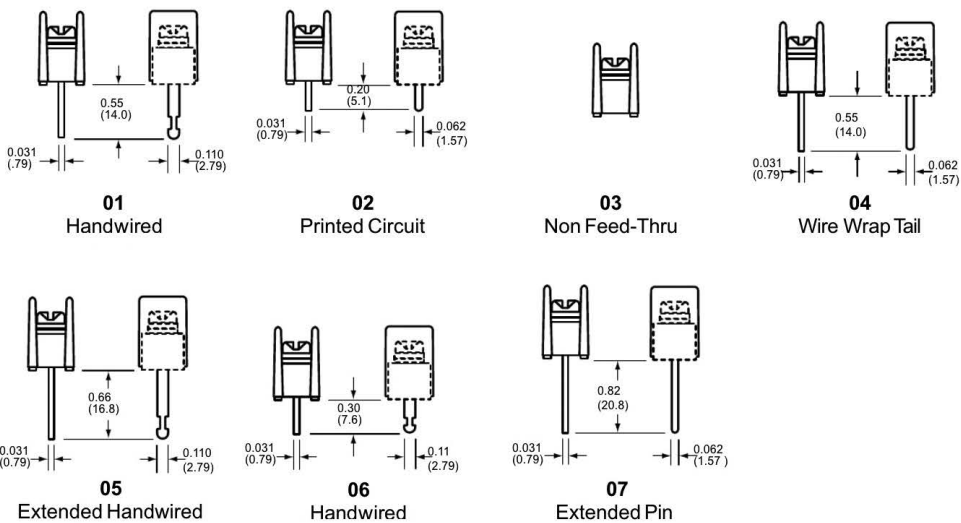

Screw Options

(Bulk ordering part numbers are in parentheses)



Standard
Zinc-Plated Steel
(F505-J)



04
Brass
Nickel-Plated
(F506-J)



07
Steel SEMS
Zinc-Plated
(F523-J)

Hardware Options Inches (Millimeters)

(Bulk ordering part numbers are in parentheses)

Jumpers



†J201
Flatslip-on
(J201-J)



†OJ3
(OJ3-J)



†OJ7
LP3 Only
(OJ7-J)



†OJ5
(OJ5-J)

† Contact Eaton for desired configuration.

Quick Connects Blade Width A = 0.250" Blade Width B = 0.187"

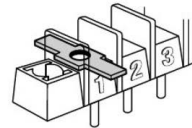

A1 & B1
(2A1-J & 2B1-J)



A2 & B2
(2A2-J & 2B2-J)

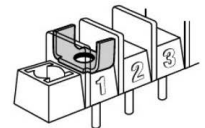

A3 & B3
(2A3-J & 2B3-J)

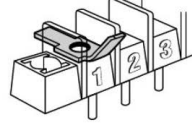

A4 & B4
(2A4-J & 2B4-J)

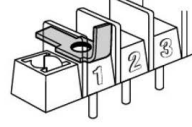

A5 & B5
(2A5-J & 2B5-J)

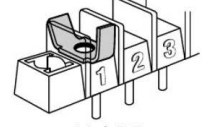

A6 & B6
(2A6-J & 2B6-J)

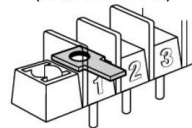

A7 & B7
(2A7-J & 2B7-J)

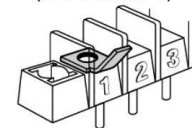

A8 & B8
(2A8-J & 2B8-J)

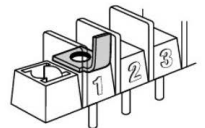

A9 & B9
(2A9-J & 2B9-J)

Base/End Options Inches (Millimeters)



1 - Standard base/mount end



2 - Standard base/barrier end



3 - Insulator base/mount end

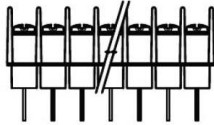
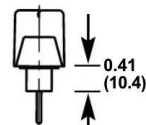

4 - Insulator base/barrier end

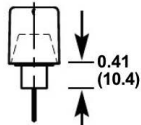

5 - Closed base/mount end



Mount End Details

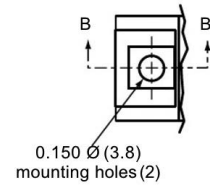

0.150 Ø (3.8)
mounting holes (2)

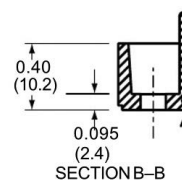

SECTION B-B

1, 3 & 5 Mount End

Note: On 1, 3 and 5 bases, Eaton may drill a terminal spacing to be a mount end. There will be no fit/form/function effect of mounting the product

Mounting Options Inches (Millimeters)

Right Angle Mounting Bracket

Right angle terminals are offered on the A3 & LP3. Configurations are defined in these dimensions: X = pin extension beyond the block base; Z = length from block base to centerline of the terminal tip. Standard bends consist of the X and Z dimensions shown in the chart. Specify by adding the selected Bend Option Code to the terminal part number.

04 Terminal Bend Configurations

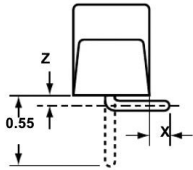

Bend Option Code	X (minimum)	Z	Available w/insulator base
R36	0.02	0.22	No
R42	0.08	0.16	No
R46	0.12	0.12	No
R50	0.16	0.08	No

Dimensions in inches. To convert to millimeters, multiply by 25.4.

07 Terminal Bend Configurations

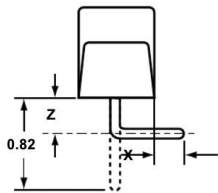

Bend Option Code	X (minimum)	Z	Available w/insulator base
R36	0.02	0.49	Yes
R50	0.16	0.35	No
R66	0.32	0.19	No

Dimensions in inches. To convert to millimeters, multiply by 25.4.

Angle Brackets (A3 only)

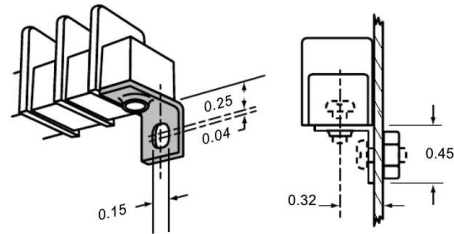

Option AB

Angle brackets enable block to be fastened at right angles to normal mount position. Bulk part number **2AB-J**.

Mounting Plates

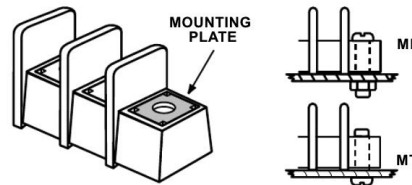

Options MP & MT

MP Metal inserts with 0.150" dia. hole accept #6 screw.
MT Metal inserts with tapped hole accept #6-32 screw.
 Bulk part number **2MP-J, 2MT-J**.

Retaining Clip

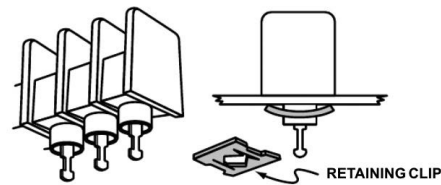

Options RC

Use on standoff tubes. Fit panels up to 0.125" thick. Two clips for every five positions. Supplied unassembled. Bulk part number **H541-J**.

Part Numbering System

Family



CB3 - closed back

Terminal Style

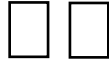

01 - handwired
#6-32 screw

02 - printed circuit
#6-32 screw

07 - extended pin
#6-32 screw

51* - handwired
#8-32 screw

52* - printed circuit
#8-32 screw

Base/End



1 - mount end

2 - barrier end

Poles



02 to 22 barrier
end

02 to 20
on mount
end

Screw Options

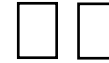

07 - steel SEMS
(standard)

09 - brass SEMS
nickel-plated

CA - SEMS captive

Options

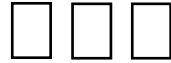

A7 to A9 - 0.250" QC

B7 to B9 - 0.187" QC

EB exit back terminals
L1 to L6 marking options
(pg 25)

LT1 to LT6 marking options
(pg 25)

MP mtg. plates (pg 20)

Covers - (pg 26)

*Note: #8-32 screw is a special with #6-32 head.

Terminal Styles Inches (Millimeters)

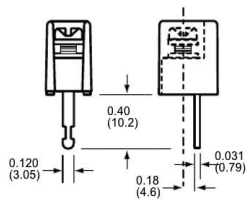

01

Handwired #6-32 screw

51

Handwired #8-32 screw

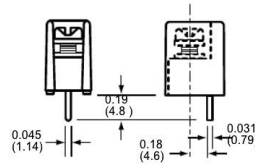

02

Printed Circuit #6-32 screw

52

Printed Circuit #8-32 screw

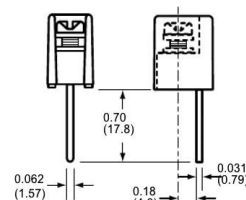

07

Extended Pin #6-32
screw

Screw Options

(Bulk ordering part numbers are in parentheses)



07

Steel SEMS
Zinc-Plated
(standard)
(B001-7084-J)



09

Brass SEMS
Nickel-Plated
(F524-J)

CB3 Terminal Exit Options Inches (Millimeters)

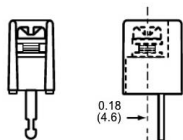

Exit Rear (std.)

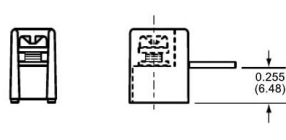

EB
Exit Back

Hardware Options

Inches (Millimeters)

(Bulk ordering part numbers are in parentheses)



†OJ3
(OJ3-J)

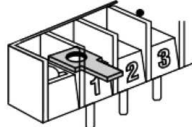

A7 & B7
(2A7-J & 2B7-J)

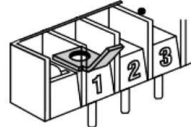

A8 & B8
(2A8-J & 2B8-J)



A9 & B9
(2A9-J & 2B9-J)



†OJ7
(OJ7-J)

† Contact Eaton for desired configuration.

Mounting Options Inches (Millimeters)

Mounting Plates

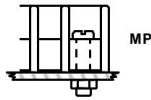
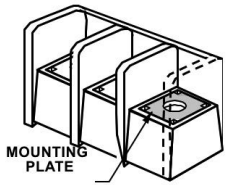

Options MP

MP Metal inserts with 0.150" dia. hole accept #6 screw.

Single Row Terminal Blocks

A38 & B38

Dimensions Inches (Millimeters)

A38

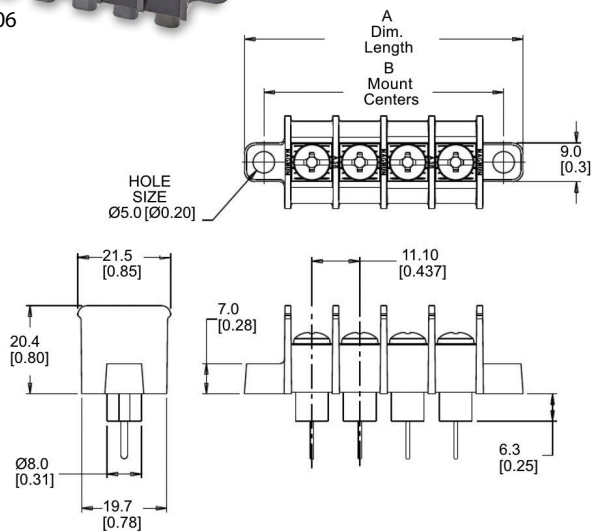

B38

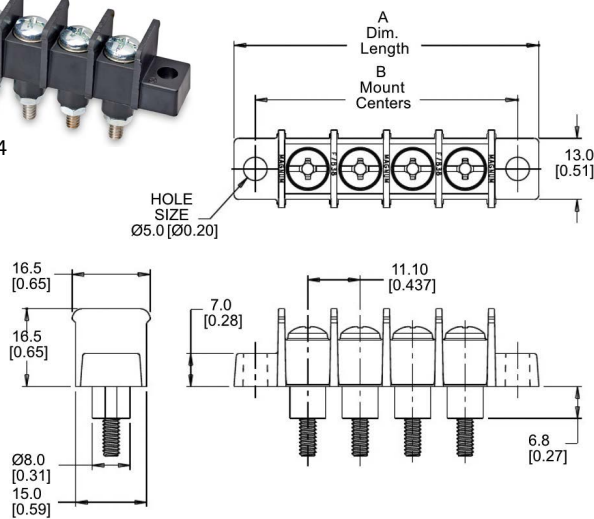

Specifications

A38: 30A, 600V

B38: 50A, 300V

Center Spacing: 0.437" (11.10mm)

Wire Range: A38: #10-22 AWG Cu; B38: #8-16 AWG

Screw Size: #8-32 zinc-plated steel

Torque Rating: A38: 9 lb-in; B38: 15 lb-in for #8, 9 lb-in for #6

Base: A38 Only: Standoffs standard for easy flux washing

Distance Between Barriers: 0.378" (9.60mm)

Recommended PCB Hole Diameter (A38): 0.076" (1.93mm)

Operating Temperature: 105°C (221°F) max to -40°C (-40°F)

Molded Material: Black, UL Rated 94V0 Thermoplastic

Breakdown Voltage: 5000V

Agency Information: UL File E62622, CSA File 47235; CE Certified

Poles	MOUNTING ENDS ONLY		BARRIER ENDS ONLY
	A Mounting Centers	"A" Dimension Length	"A" Dimension Length
02	1.31	1.67	0.93
03	1.75	2.10	1.37
04	2.19	2.54	1.81
05	2.62	2.98	2.25
06	3.06	3.41	2.68
07	3.50	3.85	3.12
08	3.93	4.29	3.56
09	4.37	4.72	3.99
10	4.81	5.16	4.43
11	5.24	5.60	4.87
12	5.68	6.04	5.30
13	6.12	6.47	5.74
14	6.56	6.91	6.18
15	6.99	7.35	6.61
16	7.43	7.78	7.05

Dimensions in inches. To convert to millimeters, multiply by 25.4.



Powering Business Worldwide

Part Numbering System

Family	Terminal Style	Base/End	Poles	Screw Options	Options
A 3 8					
	1 - handwired* 2 - printed circuit 7 - extended wire wrap 9 - 0.250" QC*	1 - flat base, mount end 2 - flat base, barrier end 3 - insulator base** mount end 4 - insulator base** barrier end	02 to 16	Blank - standard screw (steel zinc-plated, philslot BHMS) 04 - brass, nickel-plated, philslot BHMS 07 - steel, SEMS zinc-plated philslot screw	L1 to L6 marking options (pg 25) Covers - (pg 26)

Family	Terminal Style	Base/End	Poles	Screw Options	Options
B 3 8					
	3 - screw terminal (#6-32 screw top & bottom) 4 - stud (#8-32 screw top, #6-32 stud bottom) 5* - double stud (#6-32 stud top & bottom) *C360 Copper Alloy (bright tin plate)	4 - insulator base, barrier end 9 - insulator base, mount end	02 to 16	Blank - standard screw (steel zinc-plated, philslot BHMS) 34** - #6-32 nickel-plated brass philslot BHMS **Note: 34 screws only available with "3" terminal style	L1 to L6 marking options (pg 25) Covers - (pg 26)

A38 Terminal Styles Inches (Millimeters)

Wire ready screws standard

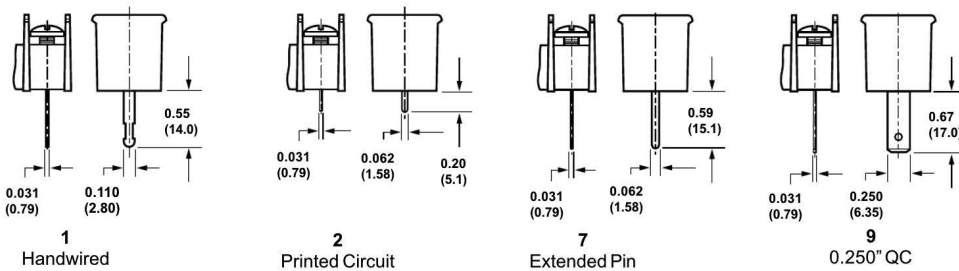

B38 Terminal Styles

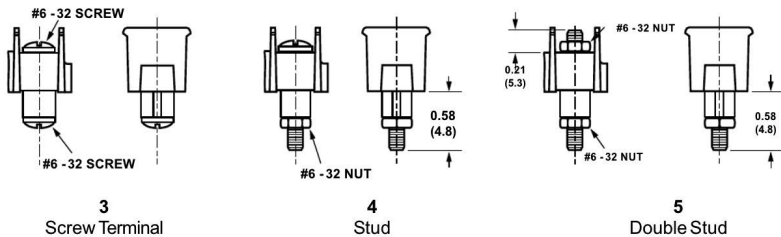

Screw Options

(Bulk ordering part numbers are in parentheses)

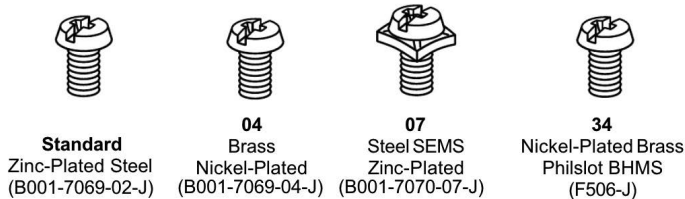

Single Row Terminal Blocks

A & B4

A4



A400303

B4



B484302

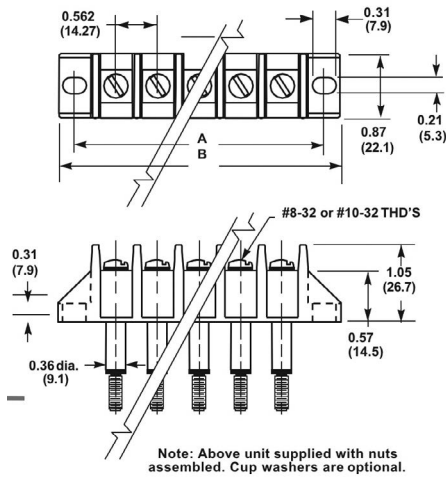

Specifications

Rating: See table.

Center Spacing: 0.562" or 9/16" (14.28mm)

Wire Range: See rating table.

Screw Size: #8-32 or #10-32 zinc-plated slotted screws

Torque Rating: #8 screw size 16 lb-in.

#10 screw size 20 lb-in.

Distance Between Barriers: 0.47" (11.9mm)

Operating Temperature: 105°C (221°F) max., -40°C (-40°F) min.

Molded Material: Black, UL Rated 94V0 Thermoplastic

Hardware: Bottom studs supplied with nuts assembled.

Extended Hex Nuts: Optional extended, slotted hex nuts enable easier installation and removal with hex wrench or screwdriver. Available in bulk for the #10-32 studs on A4953 blocks. Specify part number F582 and quantity.

Breakdown Voltage: 6100V

Agency Information: UL File E62622, CSA File 47235; CE Certified

Dimensions Inches (Millimeters)

MOUNTING ENDS ONLY

Poles	"A" Mounting Centers	"B" Dimension Length
02	1.690	2.120
03	2.255	2.685
04	2.820	3.250
05	3.385	3.817
06	3.950	4.382
07	4.515	4.947
08	5.080	5.513
09	5.645	6.078
10	6.212	6.644
11	6.777	7.210
12	7.342	7.775
13	7.908	8.340
14	8.473	8.905
15	9.038	9.470
16	9.605	10.035

Dimensions in inches. To convert to millimeters, multiply by 25.4.

Rating Table

Part Number	Terminal Top	Terminal Bottom	Wire* Range Cu	Ratings* Volts/ Amps
A4003XX	# 8 Screw	#8 Stud	8-16 AWG	150V/50A
A4011XX	# 8 Screw	Solder	10-16 AWG	600V/35A
A4013XX	# 8 Screw	Solder	10-16 AWG	600V/35A
A4035XX	# 8 Screw	Closed	8-16 AWG	600V/50A
A4041XX	#10 Screw	Solder	10-16 AWG	600V/35A
A4043XX	#10 Screw	Solder	10-16 AWG	600V/35A
A4813XX	#10 Screw	SolderTurret	10-16 AWG	600V/35A
A4843XX	#10 Screw	#8 Screw	8-16 AWG	150V/50A
A4953XX	#10 Stud	#10 Stud	8-16 AWG	150V/50A
B4843XX	#10 Screw	#8 Screw	8-16 AWG	600V/50A

* All models 30A Max. with 10 AWG

35-50A ratings with 8 AWG using ring or fork type terminals.



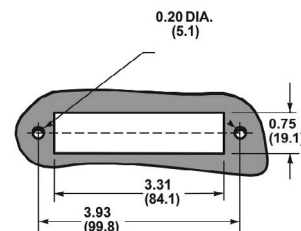

Note: 50A rating achieved with #8 copper wire crimped to ring terminal.

Reference Panel Cutout for 6 Position Block



Powering Business Worldwide

Part Numbering System

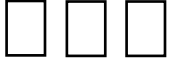
Family	Terminal Style	Base/End	Poles	Screw Options	Options
 A4 B4	 00 - screw top; stud bottom 01 - screw top; solder bottom 03 - screw top only 04 - #10 screw top; solder term. b. 81 - screw top; solder turret bottom #10-32 84 - screw top; screw bottom #10-32 95 - stud top*, stud bottom	 *1 - flat base/mount end 3 - insulator base-(not available in 03 terminal style)/mount end 5 - closed base/mount end (available in 03 terminal only)	 02 to 16	 Blank - std. screws 00 - screws shipped bulk 04 - brass nickel-plated† 07 - steel SEMS zinc plated (not available with hardware options; only available on A4011, A4013, A4021 and A4035)	 A1 to A9 0.250" QC L1 to L6 marking options (pg 25) Covers - (pg 26)

* Available in 01, 04 terminal styles only

Terminal Styles Inches (Millimeters)

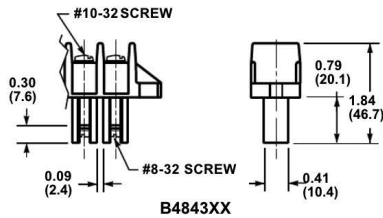
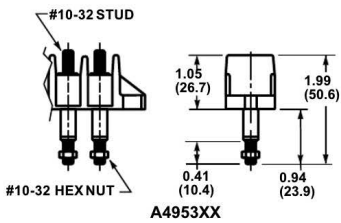
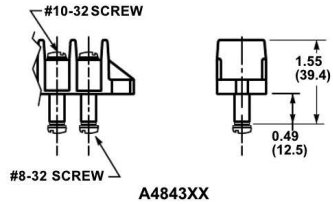
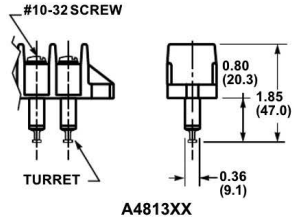
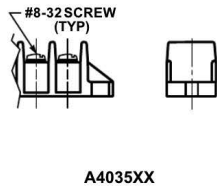
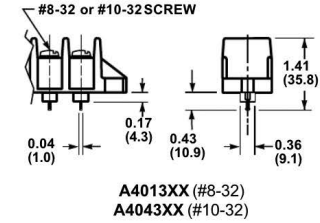
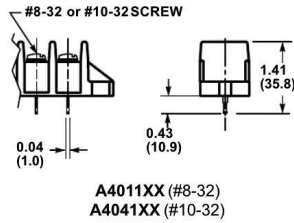
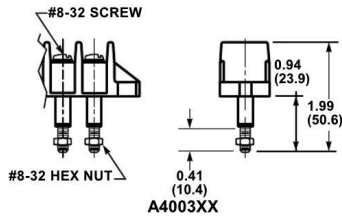

Hardware Options Inches (Millimeters)

(Bulk ordering part numbers are in parentheses)

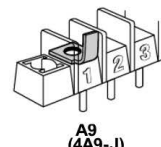
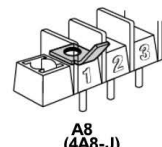
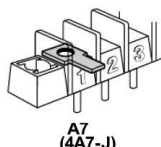
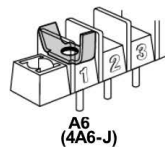
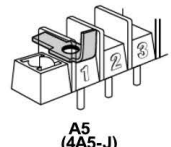
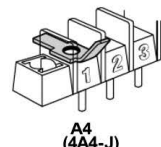
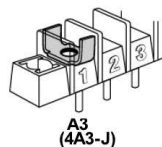
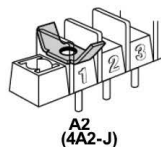
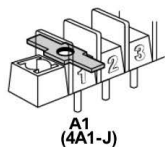
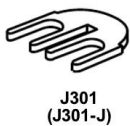

Marking Options & Accessories

Standard Marking

Markings are applied directly to the sides of A0, CB0, A1, CB11, A2, LP2, CB2, A3, LP3, CB3, A38, B38, A&B4. Standard characters are white and 1/8" high. Factory may substitute 3/32" high characters.

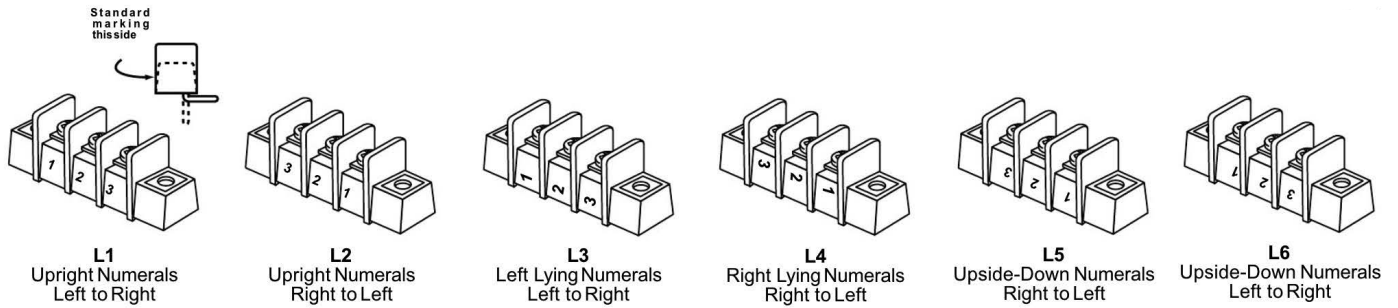

Blocks to be marked on both sides require a different code for each side. Example: "L1" on one side of the block requires "L2" on the other side to ensure common terminal marking. Specify by adding suffix to part number.

Special Marking

Special markings are available upon request at an additional charge for preparation. Production charges for setup, handling and marking are the same as for standard marking and the same quantity discounts apply. Consult factory for price and delivery.

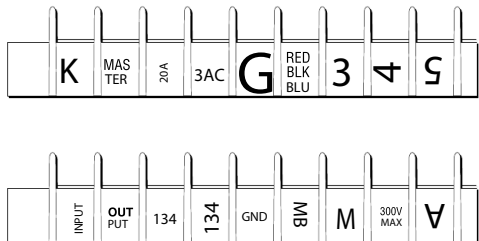

Closed Barrier Terminal Block Marking Options for (CB11, CB2 and CB3)

- L1 & LT1 = Upright numerals, numbered from left to right
- L2 & LT2 = Upright numerals, numbered from right to left
- L3 = Left lying numerals, numbered from left to right
- L4 = Right lying numerals, numbered from right to left
- L5 & LT5 = Upside down numerals, numbered from right to left
- L6 & LT6 = Upside down numerals, numbered from left to right

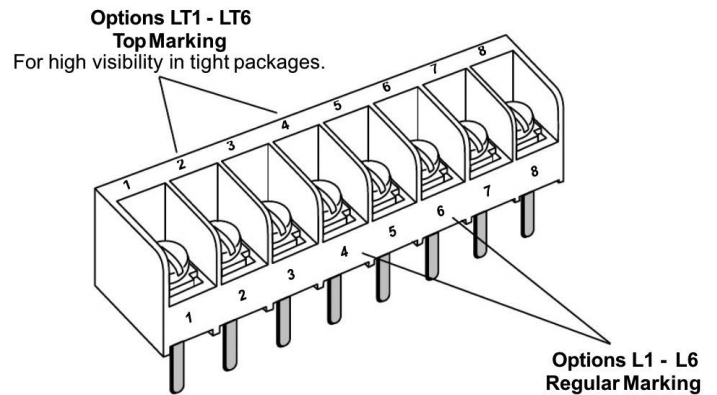

All Accessories

Single Row Terminal Blocks

Cover Options - Single Row

Terminal Block Covers

Available for A1, A2, A3, A & B4, LP2, & LP. (mount ends only)

Three styles of UL 94V0 thermoplastic covers are offered in black. Covers are ordered separately and supplied with two clips each, unless ordered without clips. Optional markings may be specified (white on black).

Notes: Covers **cannot** be used with:

- mounting plate options MP & MT.
- certain quick connect terminals.
- 6 base/end styles on A2

Bulk Cover Clips: 1000 Family = **CC1-J**; 2000 & 3000 Family = **CC2-J**; 4000 Family = **CC4-J**.

Standard Cover Markings

Top Forward - TF



Bottom Forward - BF
Skirted Access Side

Top Reverse - TR

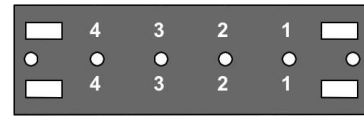

Bottom Reverse - BR
Skirted Access Side



Cover Options BB
Skirted access on both sides.

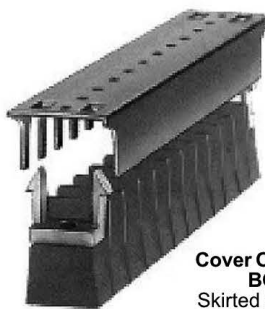

Cover Options BO
Skirted access on one side only.

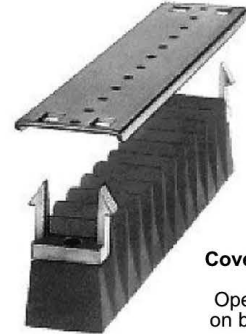

Cover Options BC
Open access on both sides.

Cover



BB - skirted access, both sides, black

BO - skirted access, one side, black

BC - open access, both sides, black*

* Not available in 4000



1 - 1000

2 - 2000

3 - 3000

4 - 4000

Poles



02 to 36

Markings (if desired)



BF - bottom forward

TF - top forward

BR - bottom reverse

TR - top reverse

Options



00 - without clips

Snap-On Covers for A38/B38/A0 & CB2/CB3

Can be used on both mount ends and barrier bases

A38/B38/A0



CB2/CB3



T A 8 - [] [] **A38**

T B 8 - [] [] **B38**

T A 0 - [] [] **A0**

Poles

T O 2 - [] [] **CB2**

T O 3 - [] [] **CB3**

Note: these are labeled as the letter "O" not a "zero"

Contact Us

Sales and Customer Service

Americas

Email: elx.americas@eaton.com

Europe, Middle East, Africa

Email: elx.emea@eaton.com

China

Email: elx.cn@eaton.com

Japan

Email: elx.jp@eaton.com

Korea

Email: elx.kr@eaton.com

South East Asia

Email: elx.sea@eaton.com

Taiwan

Email: elx.tw@eaton.com

Global Technical Support

Magnetics: InductorTech@eaton.com

Circuit Protection: FuseTech@eaton.com

Supercapacitors: CapacitorTech@eaton.com

www.eaton.com/terminalblocks

Tools

Eaton's Electronics Product Selection Tools



PARAMETRIC SEARCH

Drill down into the Eaton Electronics product database to find the right part for your application.



IC MATCHING

Find the Eaton Electronics parts called out on IC manufacturers' demo and evaluation boards.



CROSS REFERENCE

Find a cross to a competitor's product or to an alternate Eaton Electronics part number.



SUPERCAPACITOR CALCULATOR

Determine your calculated requirements and design capability.



TERMINAL BLOCK SELECTOR

Find the right terminal block for any application.



AUTOMOTIVE ELECTRONICS SOLUTIONS

Find electronics components for automotive solutions.

tools.eatonelectronics.com