

Schematic:

(One of Four)

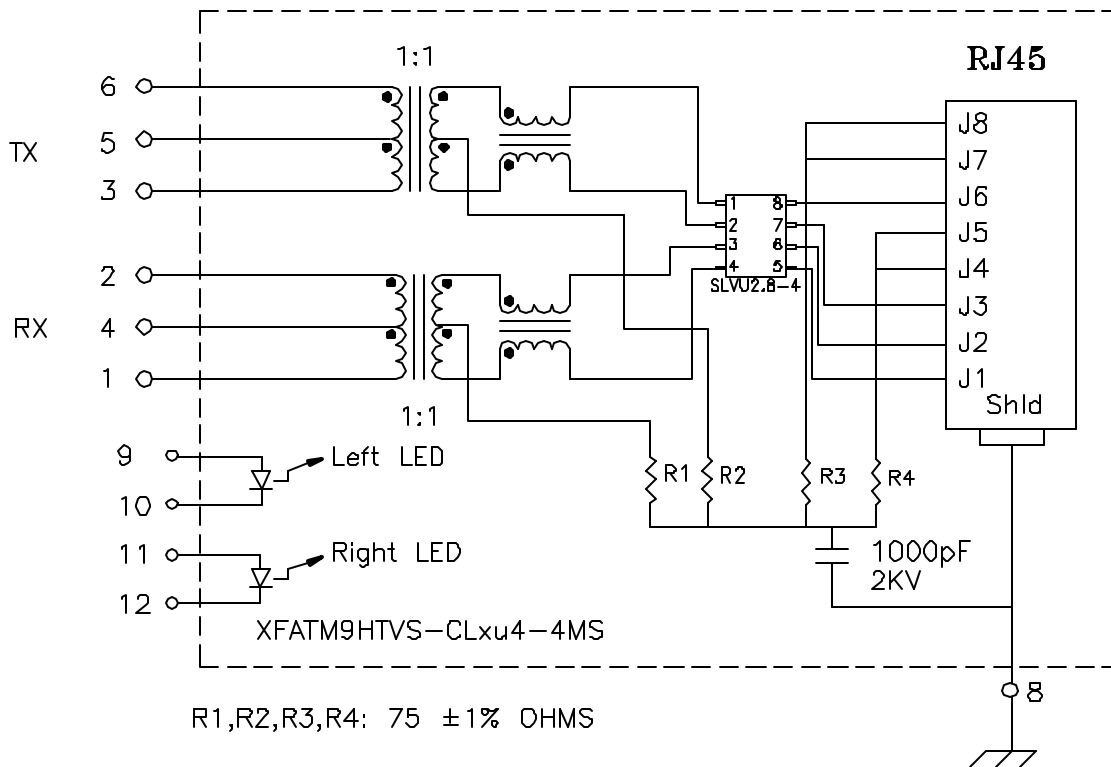

Electrical Specifications: @25°C

Isolation Voltage: 1500 Vac

Isolation Voltage: 500 Vac (1+4+2 to 3+5+6)

UTP SIDE OCL: 350uH Min @100KHz 100mV 8mADC

Leakage Inductance: P6-P3 0.3uH Max @100KHz 100mV Short J6 and J3

Leakage Inductance: P2-P1 0.3uH Max @100KHz 100mV Short J2 and J1

C_{ww}: (P6, P5, & P3) to (J6 & J3) 30pF Typ @100KHz 100mV

C_{ww}: (P2, P4, & P1) to (J2 & J1) 30pF Typ @100KHz 100mV

DCR: (J6-J3) = (J2-J1) 1.2 Ohms Max

Rise Time (10-90%): 2.5ns Typ

Insertion Loss (100KHz-100MHz): -1.2dB Max

Return Loss: -18dB Min @1MHz - 30MHz

Return Loss: -12dB Min @60MHz - 80MHz

Crosstalk: 40dB Typ @1MHz to 100MHz

Common Mode to Differential Mode Rejection:

30MHz-100MHz -35dB Typ (Tx) / -35dB Typ (Rx)

Notes:

- Solderability: Leads shall meet MIL-STD-202, Method 208D for solderability.
- Flammability, UL94V-0
- ASTM oxygen index: > 28%
- Insulation System, Class F 155°C, UL file E151556
- Operating Temperature Range: All listed parameters are to be within tolerance from -40°C to +85°C
- Storage Temperature Range: -55°C to +125°C
- Aqueous wash compatible

DOC. REV: A/1

XFMRs Inc.	Title: 1x4 PORT COMBO		
	UNLESS OTHERWISE SPECIFIED TOLERANCES: .xxx ±0.010		P/N: XFATM9HTVS-CLxu4-4MS
	Dimensions in Inch		REV. A
	SHEET 1 OF 2		
	DWN.	罗振江	Feb-11-04
	CHK.	廖玉坤	Feb-11-04
	APP.	MS	Feb-11-04

Mechanical Dimensions: (FOR CLxu4-4MS)

Complete the Combo P/N as follows:

Replace 'x' & 'u' in the part number with one of the LED color letters:

Y=Yellow 'x' = Left LED Color
 G=Green 'u' = Right LED Color
 A=Amber
 R=Red

C=Green(1)/Amber(2) Bicolor
 D=Amber(1)/Green(2) Bicolor
 M=Green(1)/Yellow(2) Bicolor
 N=Yellow(1)/Green(2) Bicolor
 P=Red(1)/Green(2) Bicolor
 Q=Green(1)/Red(2) Bicolor

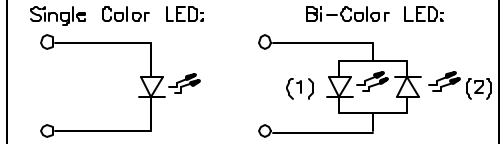

Marking on top:

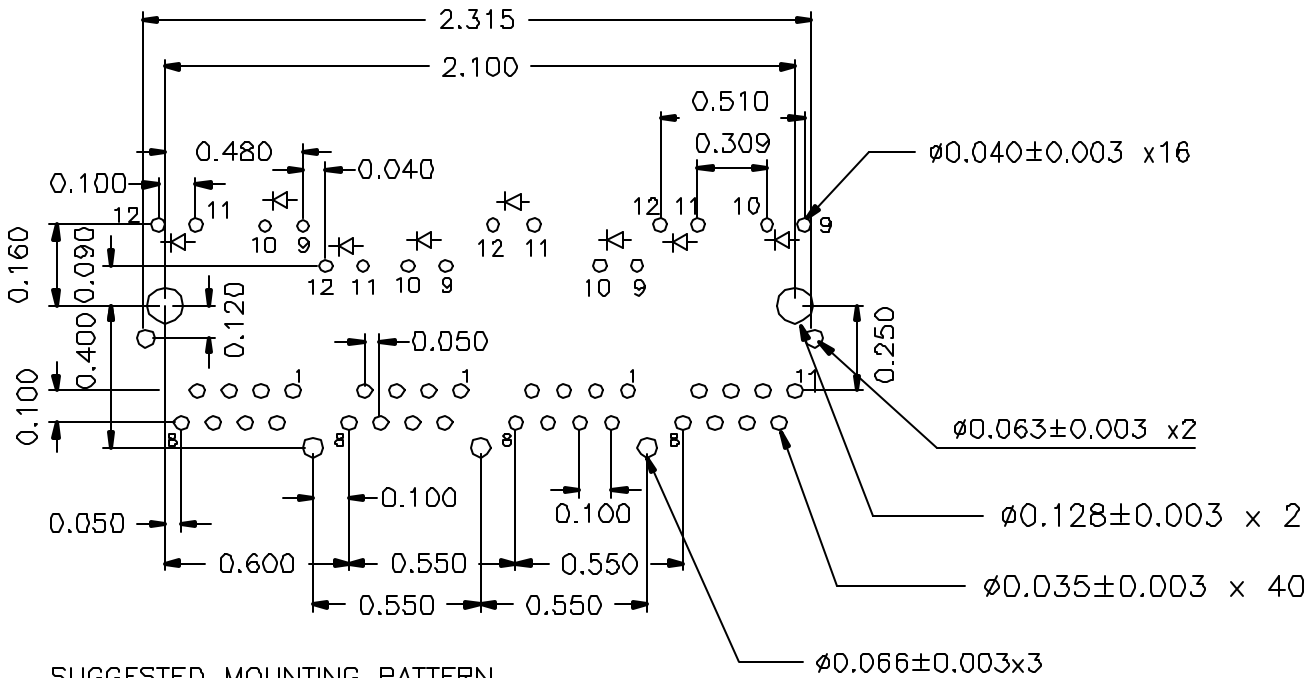
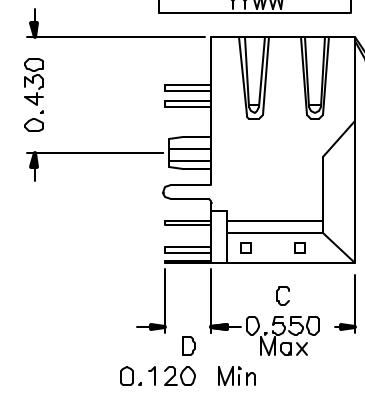
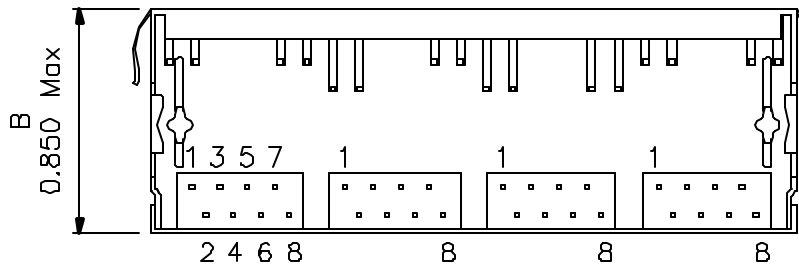
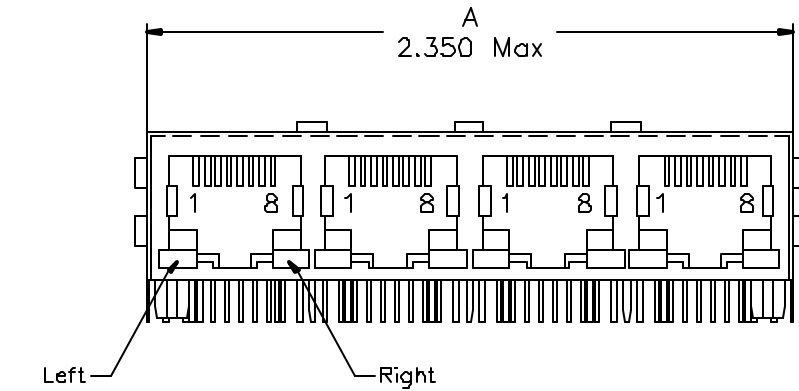
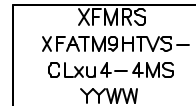

SUGGESTED MOUNTING PATTERN

DOC REV: A/1

XFMR5 Inc.	Title: FOUR PORT COMBO w/ LED's		
	UNLESS OTHERWISE SPECIFIED TOLERANCES: .xxx ±0.010 Dimensions in Inch	P/N: XFATM9HTVS-CLxu4-4MS	REV. A
SHEET 2 OF 2	DWN.	罗振江	Feb-11-04
	CHK.	廖玉坤	Feb-11-04
	APP.	MS	Feb-11-04