

Description

The AP2318A is a series of ultra low dropout regulators optimized for low voltage applications where transient response and minimum input voltage are critical.

The AP2318A provides current limit and thermal shutdown function. Its circuit includes a trimmed bandgap reference to assure output voltage accuracy to be within $\pm 1.5\%$. On-chip thermal shutdown provides protection against any combination of overload and ambient temperatures that would cause excessive junction temperatures.

The AP2318A has adjustable version, which can set the output voltage through two external resistors.

The AP2318A is available in the standard DFN-3x3-8 and PSOP-8 packages.

Features

- Wide Operating Voltage Ranges: 2.5V to 12V
- Output Voltage Accuracy: $\pm 1.5\%$
- On-chip Thermal Shutdown
- ESD Rating
 - 3000V (Human Body Model)
 - 600V (Machine Model)
- Operating Junction Temperature: -40°C to $+125^{\circ}\text{C}$

Pin Assignments

(Top View)

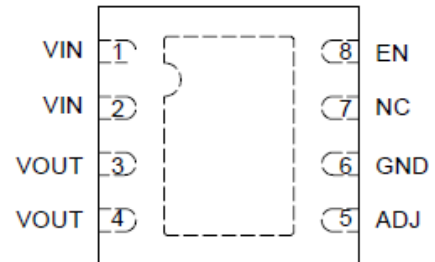

DFN-3x3-8

(Top View)

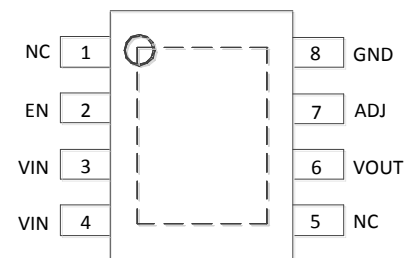

PSOP-8

Applications

- Notebook
- USB Device
- Add-on Card
- DVD Player
- PC Motherboard

Typical Applications Circuit

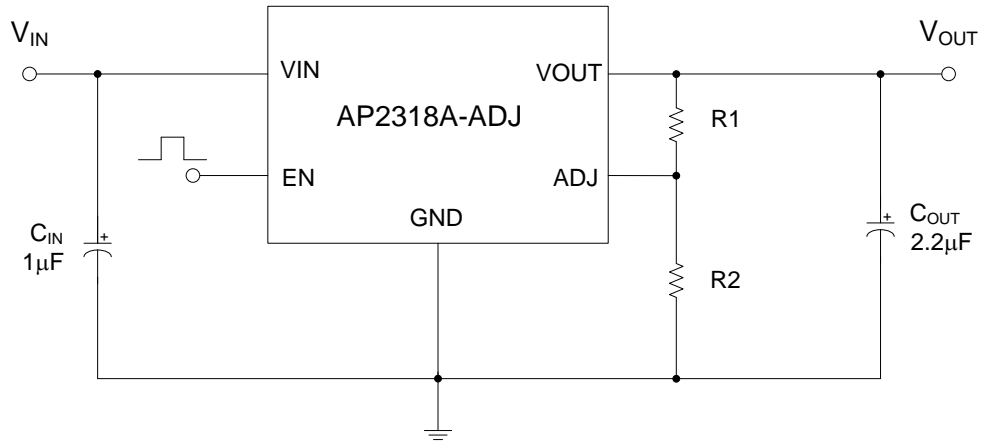

ADJ Version, $V_{OUT} = 1.25 \cdot (R1+R2)/R2$

Pin Description

Pin Number		Pin Name	Function
DFN-3x3-8	PSOP-8		
1, 2	3, 4	VIN	Input Voltage
3, 4	6	VOUT	Output Voltage
5	7	ADJ	Adjustable Voltage
6	8	GND	Ground
7	1, 5	NC	No Connection
8	2	EN	On/Off Control

Functional Block Diagram

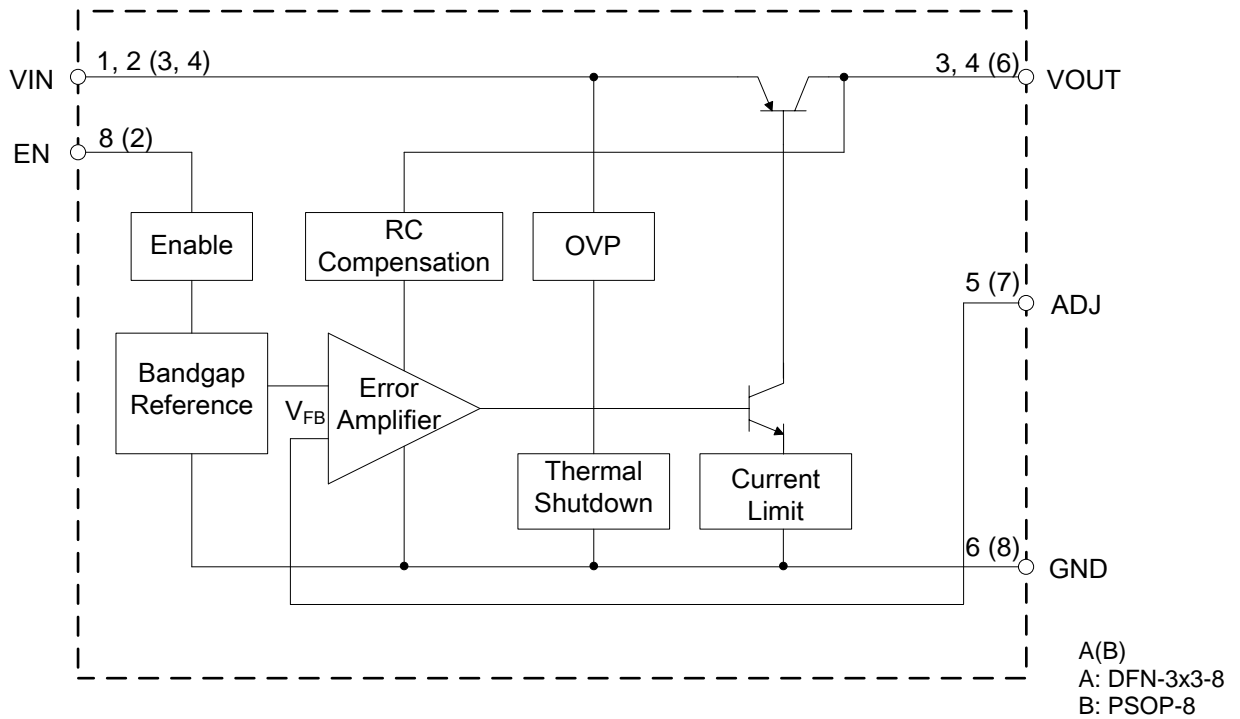

Absolute Maximum Ratings (Note 1)

Symbol	Parameter	Rating		Unit
V_{IN}	Input Voltage	15		V
T_J	Operating Junction Temperature	+150		°C
T_{STG}	Storage Temperature Range	-65 to +150		°C
T_{LEAD}	Lead Temperature (Soldering, 10sec)	+260		°C
θ_{JA}	Thermal Resistance (Junction to Ambient) (Note 2)	DFN-3x3-8	120	°C/W
		PSOP-8	108	
ESD	ESD (Human Body Model)	3000		V
ESD	ESD (Machine Model)	600		V

- Notes:
- Stresses greater than those listed under "Absolute Maximum Ratings" may cause permanent damage to the device. These are stress ratings only, and functional operation of the device at these or any other conditions beyond those indicated under "Recommended Operating Conditions" is not implied. Exposure to "Absolute Maximum Ratings" for extended periods may affect device reliability.
 - Absolute maximum ratings indicate limits beyond which damage to the component may occur. Electrical specifications do not apply when operating the device outside of its operating ratings. The maximum allowable power dissipation is a function of the maximum junction temperature, $T_J(\text{Max})$, the junction-to-ambient thermal resistance, θ_{JA} , and the ambient temperature, T_A . The maximum allowable power dissipation at any ambient temperature is calculated using: $P_D(\text{Max}) = (T_J(\text{Max}) - T_A) / \theta_{JA}$. Exceeding the maximum allowable power dissipation will result in excessive die temperature, and the regulator will go into thermal shutdown.

Recommended Operating Conditions

Symbol	Parameter	Min	Max	Unit
V_{IN}	Input Voltage	2.5	12	V
V_{EN}	Enable Voltage	—	12	V
T_J	Operating Junction Temperature Range	-40	+125	°C

Electrical Characteristics (Operating Conditions: $2.5V \leq V_{IN} \leq 12V$, $C_{IN} = 1\mu F$, $C_{OUT} = 2.2\mu F$, $T_J = +25^\circ C$, unless otherwise specified. ($P \leq$ Maximum Power Dissipation). Limits appearing in **Boldface** type apply over the entire junction temperature range for operation of -40°C to +125°C.)

Symbol	Parameter	Conditions	Min	Typ	Max	Unit
V_{REF}	Reference Voltage	AP2318A-ADJ, $I_{OUT} = 10mA$, $V_{IN}-V_{OUT} = 2V$, $T_J = +25^\circ C$, $10mA \leq I_{OUT} \leq 1A$, $V_{OUT}+2V \leq V_{IN} \leq 12V$	1.231 1.225	1.250 1.250	1.269 1.275	V
$I_{OUT(Max)}$	Maximum Output Current	$V_{IN}-V_{OUT} = 2V$	1.2	1.5	—	A
V_{RLINE}	Line Regulation	AP2318A-ADJ $I_{OUT} = 10mA$, $V_{OUT}+2V \leq V_{IN} \leq 12V$	—	1	6	mV
		$I_{OUT} = 10mA$, $2.5V \leq V_{IN} \leq 12V$	—	1	6	mV
V_{RLOAD}	Load Regulation	AP2318A-ADJ $V_{IN} = V_{OUT}+2V$, $10mA \leq I_{OUT} \leq 1A$	—	1	15	mV
		$V_{IN} = 2.5V$, $10mA \leq I_{OUT} \leq 1A$	—	1	15	mV
V_{DROP}	Dropout Voltage	$\Delta V_{OUT} (\Delta V_{REF}) = 1\%$, $V_{OUT} > 2V$, $I_{OUT} = 1A$	—	0.5	—	V
I_{ADJ}	Adjust Pin Current	—	—	0.05	1	μA
$I_{LOAD(Min)}$	Minimum Load Current	$V_{OUT}+2V \leq V_{IN} \leq 12V$ (ADJ only)	—	1.7	5	mA
I_Q	Quiescent Current	$V_{IN} = V_{OUT}+2V$, $I_{OUT} = 0mA$	—	250	—	μA
V_{NOI}	RMS Output Noise (% of V_{OUT})	$T_A = +25^\circ C$, $10Hz \leq f \leq 20kHz$	—	0.003	—	%
—	Thermal Shutdown Temperature	—	—	+150	—	°C
—	Thermal Shutdown Hysteresis	—	—	+25	—	°C
V_{EN}	Enable Input Voltage	Enable Logic Low	—	—	0.8	V
		Enable Logic High	2.25	—	—	
I_{EN}	Enable Input Current	$V_{EN} = 2.25V$	—	5	—	μA
		$V_{EN} = 0.8V$	—	—	4	μA
θ_{JC}	Thermal Resistance (Junction to Case)	DFN-3x3-8	—	15	—	°C/W
		PSOP-8	—	12	—	

Performance Characteristics

Output Voltage vs. Input Voltage

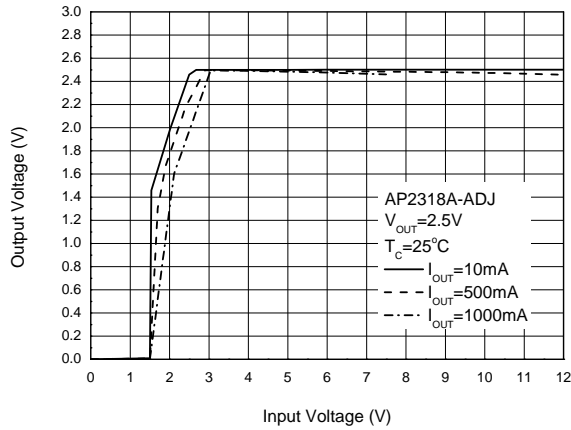

Output Voltage vs. Output Current

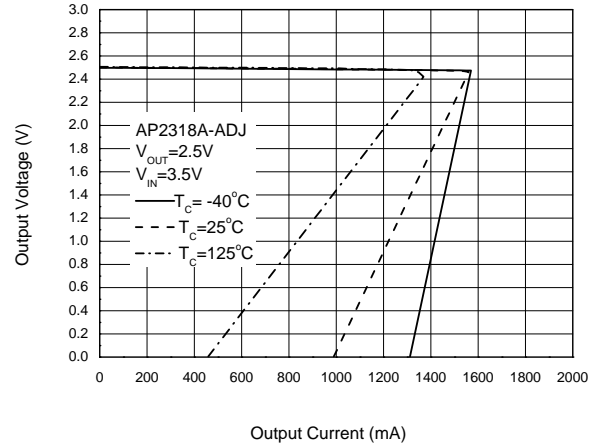

Supply Current vs. Input Voltage

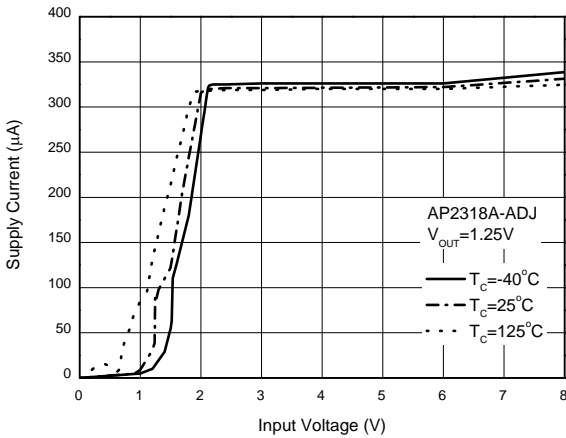

Supply Current vs. Case Temperature

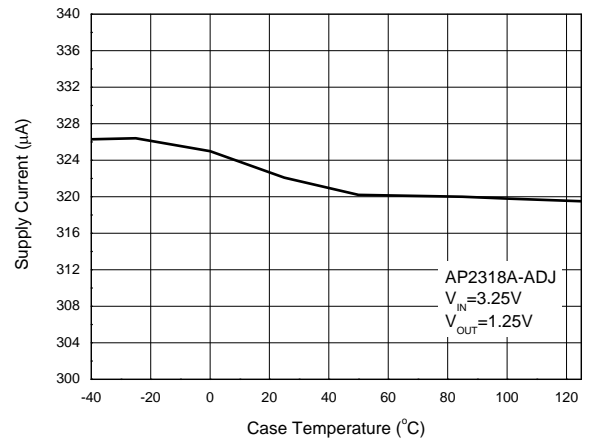

Supply Current vs. Output Current

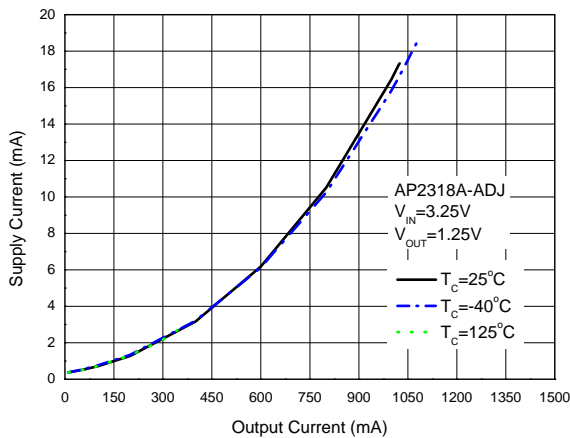

Supply Current vs. Output Current

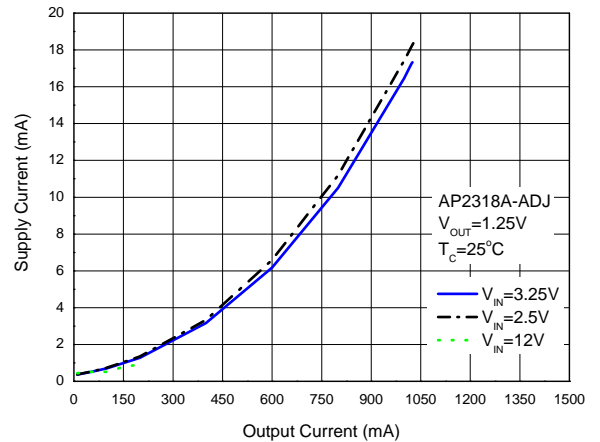

Performance Characteristics (Cont.)

Dropout Voltage vs. Output Current

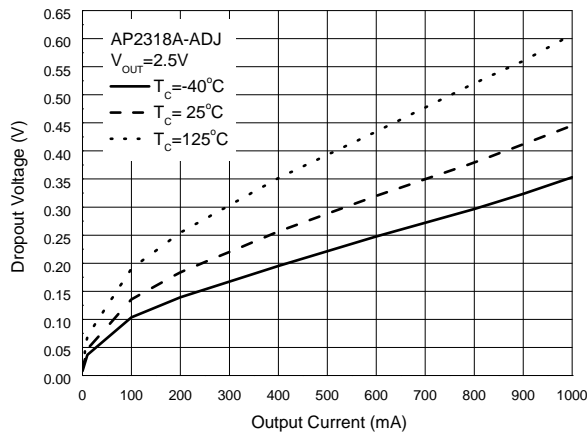

PSRR vs. Frequency

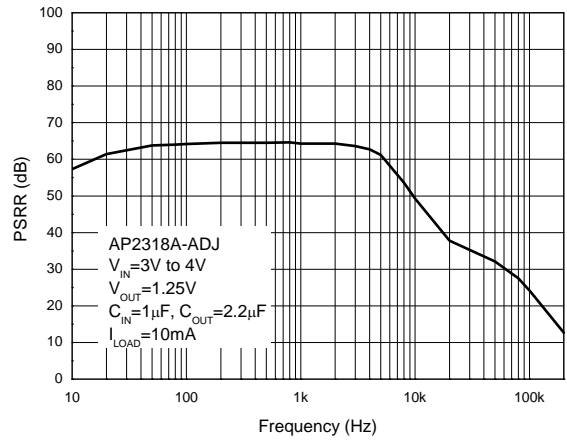

Load Transient Response
(Conditions: $V_{IN} = 2.5V$, $V_{OUT} = 1.25V$, $I_{OUT} = 1$ to $500mA$)
 $C_{IN} = 1\mu F$, $C_{OUT} = 2.2\mu F$)

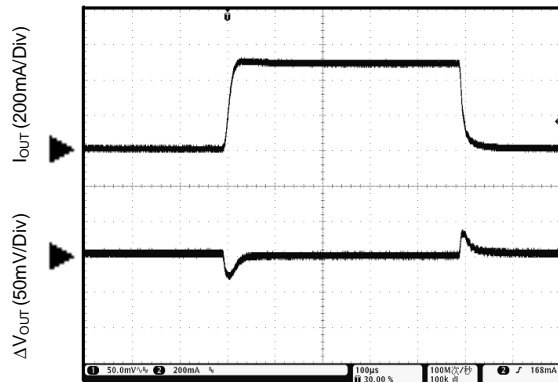

Load Transient Response
(Conditions: $V_{IN} = 2.5V$, $V_{OUT} = 1.8V$, $I_{OUT} = 1mA$ to $1A$)
 $C_{IN} = 1\mu F$, $C_{OUT} = 2.2\mu F$)

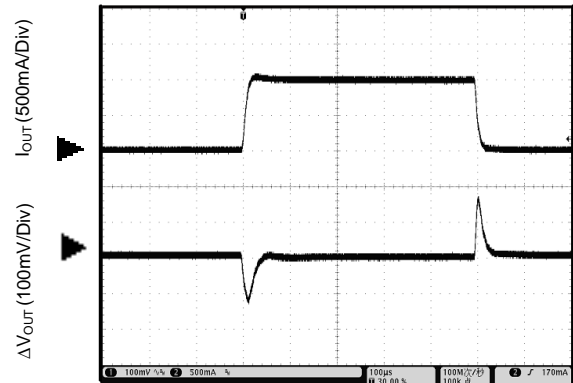

Ordering Information

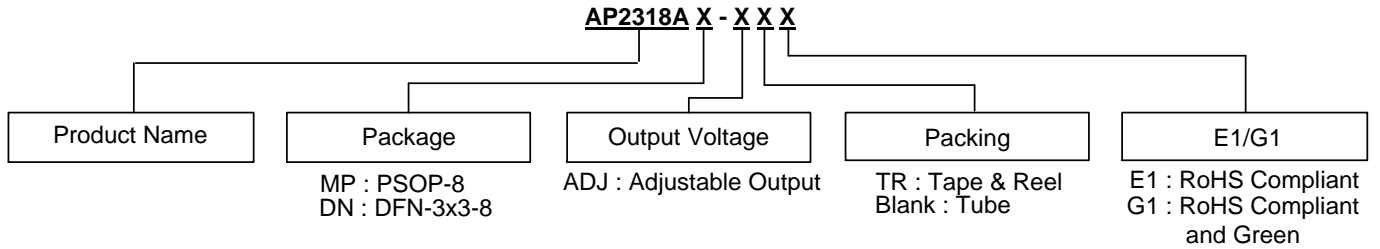

Package	Temperature Range	Part Number	Marking ID	Packing
DFN-3x3-8	-40 to +125°C	AP2318ADN-ADJTRG1	B7B	Tube
PSOP-8	-40 to +125°C	AP2318AMP-ADJE1	2318A-ADJE1	Tube
		AP2318AMP-ADJG1	2318A-ADJG1	Tube
		AP2318AMP-ADJTRE1	2318A-ADJE1	Tape & Reel
		AP2318AMP-ADJTRG1	2318A-ADJG1	Tape & Reel

Package Outline Dimensions (All dimensions in mm(inch).)

(1) Package Type: DFN-3x3-8

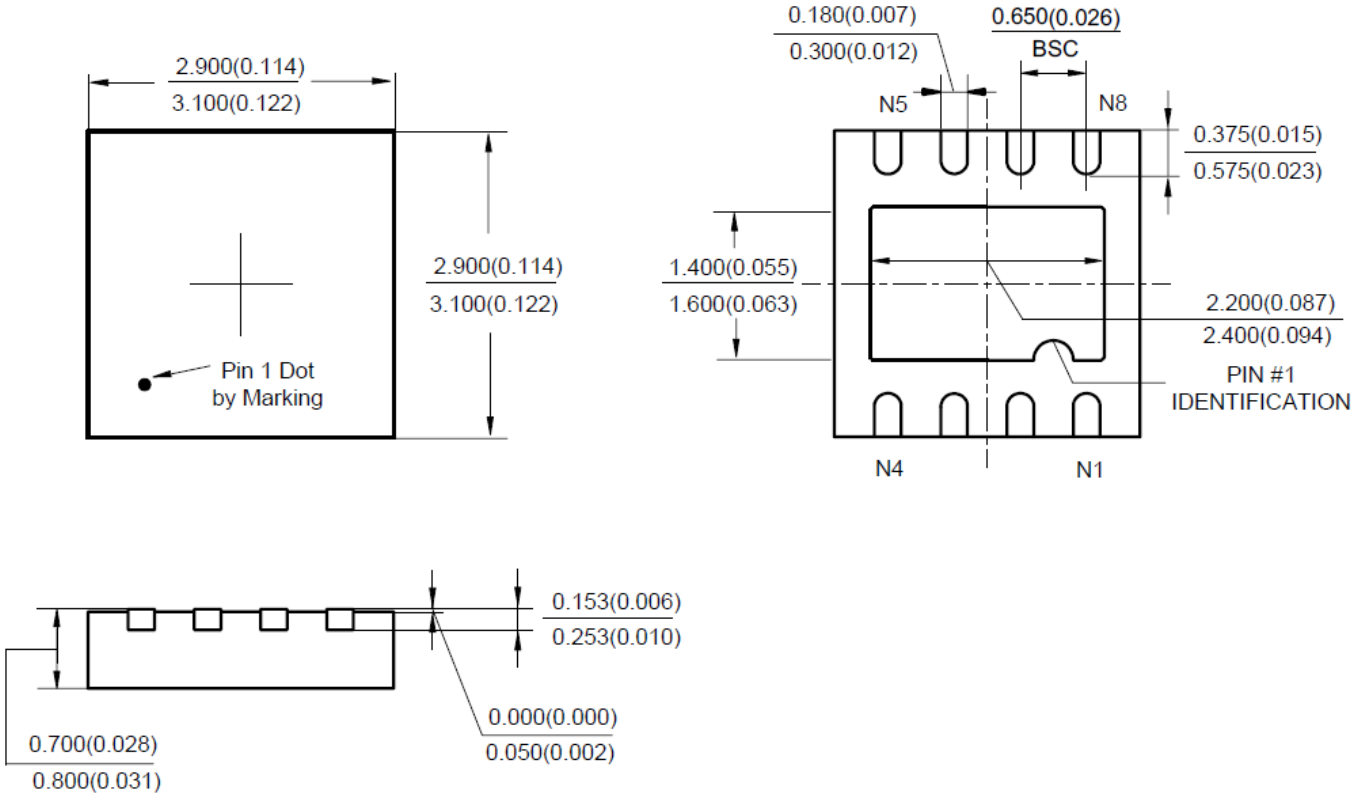

Package Outline Dimensions (Cont. All dimensions in mm(inch).)

(2) Package Type: PSOP-8

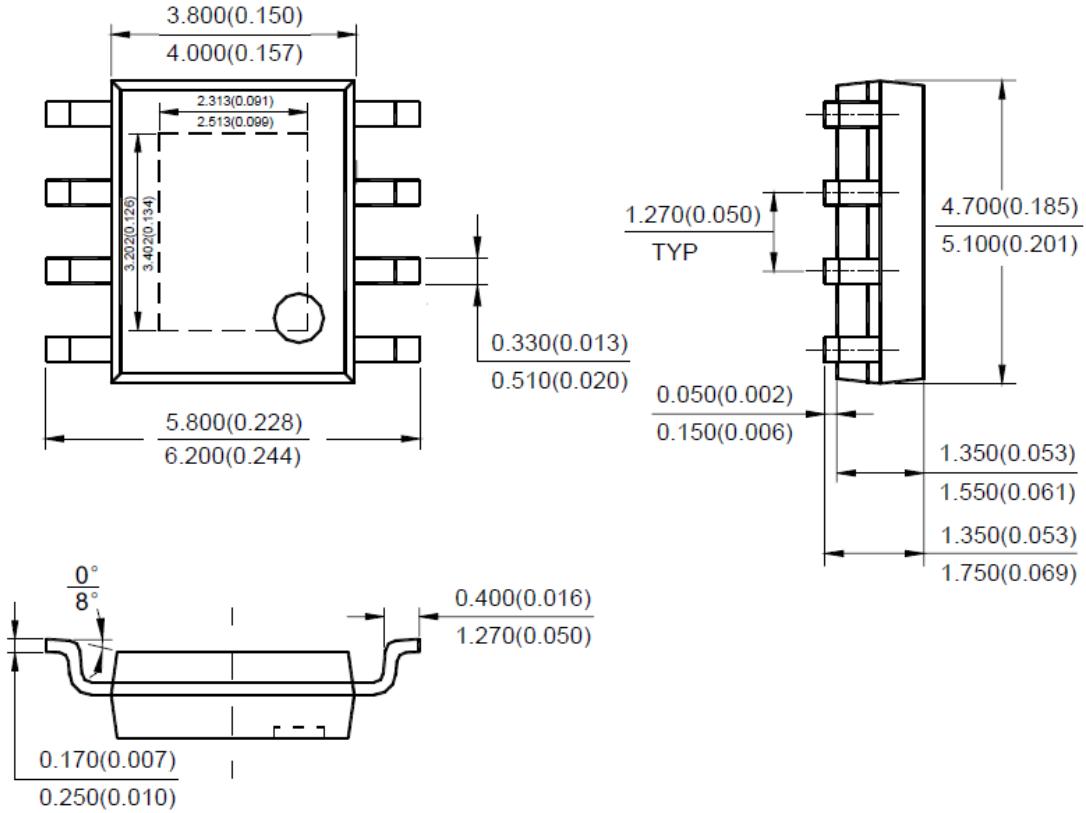

Note: Eject hole, oriented hole and mold mark is optional.

IMPORTANT NOTICE

DIODES INCORPORATED MAKES NO WARRANTY OF ANY KIND, EXPRESS OR IMPLIED, WITH REGARDS TO THIS DOCUMENT, INCLUDING, BUT NOT LIMITED TO, THE IMPLIED WARRANTIES OF MERCHANTABILITY AND FITNESS FOR A PARTICULAR PURPOSE (AND THEIR EQUIVALENTS UNDER THE LAWS OF ANY JURISDICTION).

Diodes Incorporated and its subsidiaries reserve the right to make modifications, enhancements, improvements, corrections or other changes without further notice to this document and any product described herein. Diodes Incorporated does not assume any liability arising out of the application or use of this document or any product described herein; neither does Diodes Incorporated convey any license under its patent or trademark rights, nor the rights of others. Any Customer or user of this document or products described herein in such applications shall assume all risks of such use and will agree to hold Diodes Incorporated and all the companies whose products are represented on Diodes Incorporated website, harmless against all damages.

Diodes Incorporated does not warrant or accept any liability whatsoever in respect of any products purchased through unauthorized sales channel. Should Customers purchase or use Diodes Incorporated products for any unintended or unauthorized application, Customers shall indemnify and hold Diodes Incorporated and its representatives harmless against all claims, damages, expenses, and attorney fees arising out of, directly or indirectly, any claim of personal injury or death associated with such unintended or unauthorized application.

Products described herein may be covered by one or more United States, international or foreign patents pending. Product names and markings noted herein may also be covered by one or more United States, international or foreign trademarks.

This document is written in English but may be translated into multiple languages for reference. Only the English version of this document is the final and determinative format released by Diodes Incorporated.

LIFE SUPPORT

Diodes Incorporated products are specifically not authorized for use as critical components in life support devices or systems without the express written approval of the Chief Executive Officer of Diodes Incorporated. As used herein:

A. Life support devices or systems are devices or systems which:

1. are intended to implant into the body, or
2. support or sustain life and whose failure to perform when properly used in accordance with instructions for use provided in the labeling can be reasonably expected to result in significant injury to the user.

B. A critical component is any component in a life support device or system whose failure to perform can be reasonably expected to cause the failure of the life support device or to affect its safety or effectiveness.

Customers represent that they have all necessary expertise in the safety and regulatory ramifications of their life support devices or systems, and acknowledge and agree that they are solely responsible for all legal, regulatory and safety-related requirements concerning their products and any use of Diodes Incorporated products in such safety-critical, life support devices or systems, notwithstanding any devices- or systems-related information or support that may be provided by Diodes Incorporated. Further, Customers must fully indemnify Diodes Incorporated and its representatives against any damages arising out of the use of Diodes Incorporated products in such safety-critical, life support devices or systems.

Copyright © 2018, Diodes Incorporated

www.diodes.com