

# Industrial waterproof rectangular connector

## DK-2 Series (12 Pin) Type

DDK Ltd.

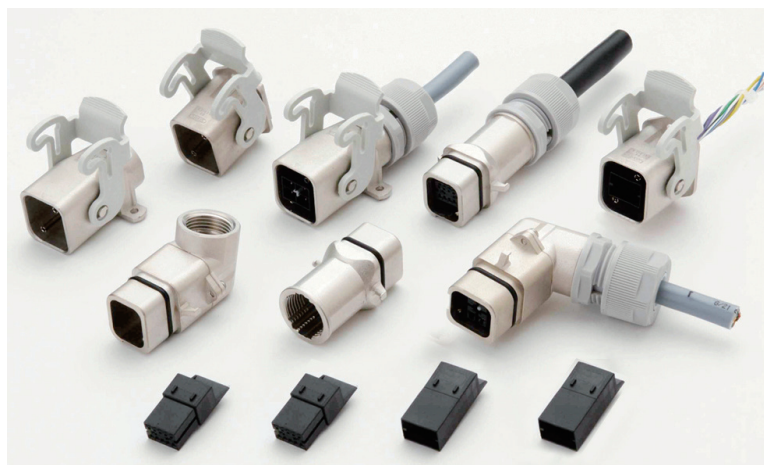

### OUTLINE

- ◆ Waterproof rectangular connector was developed for connecting industrial equipment.
- ◆ Crimp termination contacts are the same as those of DK-2000 series.
- ◆ Tab and a receptacle housing are being prepared for the shell shape of the plug, the cable receptacle and the receptacle.
- ◆ DK-2 has one touch locking lever mechanism and a locking supporting system.  
Pushing contacts in the direction of the mating half makes the connectors automatically and temporarily locked and you can mate the connectors easily.

### APPLICATIONS

FA equipment (internal and external), robots, servo motors, medical equipment, communication equipment, OA equipment, various other electrical equipment

### SPECIFICATIONS

Item	DK-2 Series
Rated Voltage	250V AC (r.m.s.)
Rated Current	5A max. / Contact
Dielectric Withstanding Voltage	1,500V AC (r.m.s.)/ 1 minute
Insulation Resistance	1,000M $\Omega$ min. at 500V DC
Contact Resistance	10m $\Omega$ max.
Contact Pitch	3.5mm
Applicable Cable Size	AWG#18 – #28
Waterproof Rating	IP67
Number of Contacts	12 Pin

### SAFETY STANDARD



Type Approved  
Safety  
Regular Production  
Surveillance

www.tuv.com  
ID 2000000000

### MATERIALS / FINISHS



Item	Materials / Finishes
Contact	Copper Alloy / Au over Ni Plating
Housing	PBT Resin (UL94V-0) / Black
Shell / Hood	Aluminum Alloy and Zinc Alloy

© Specifications and/or dimensions in this catalogue are subject to change without notice.  
Your catalogue checking the latest specifications with our drawings would be highly appreciated.

▶ 12 Pin Waterproof Connectors

Straight Plug

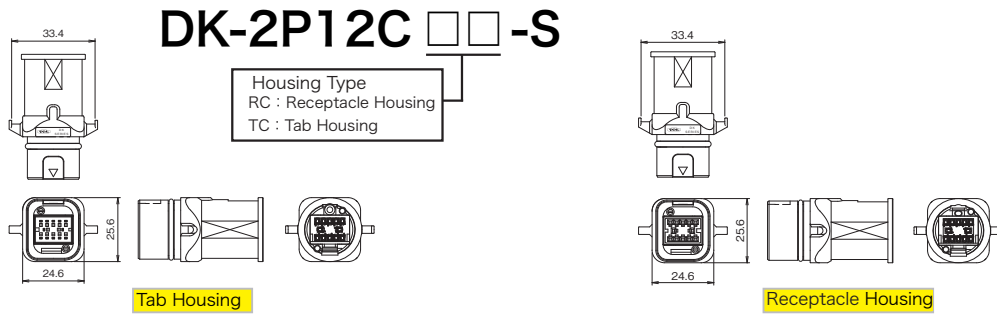

Right Angle Plug

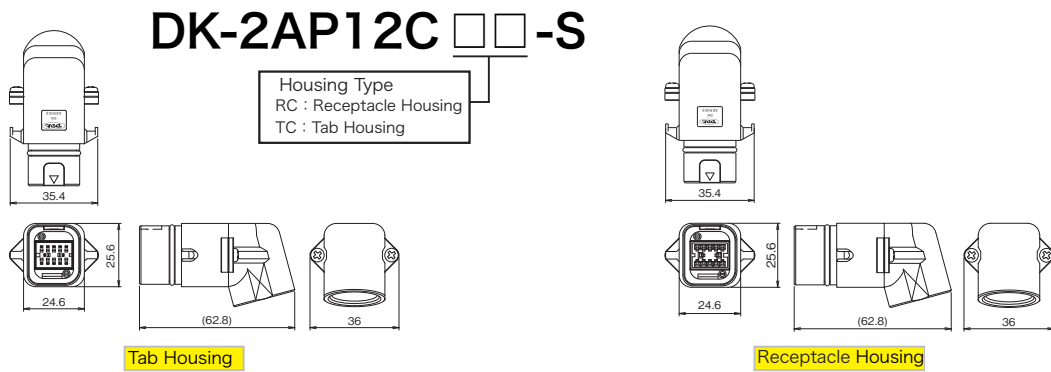

Cable Receptacle

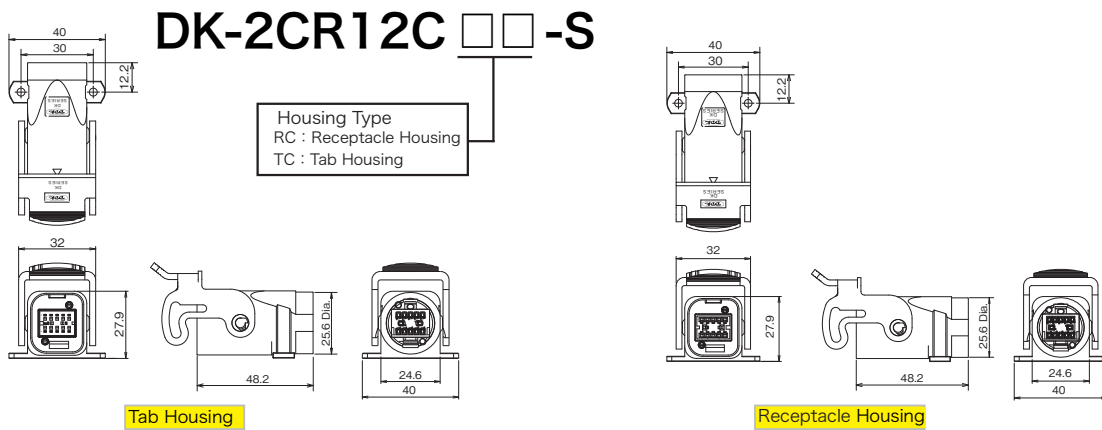

Box Receptacle

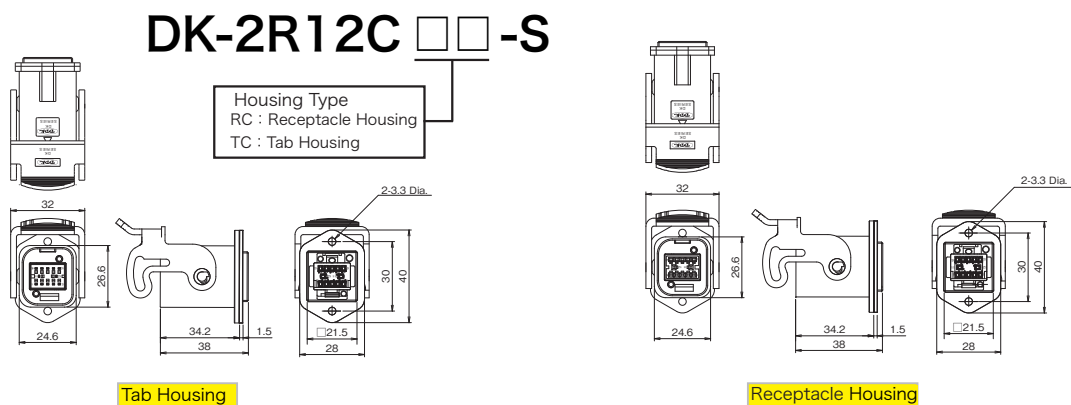

© Specifications and/or dimensions in this catalogue are subject to change without notice.  
Your catalogue checking the latest specifications with our drawings would be highly appreciated.

## ▶ Crimp Contacts

## DK-2 Contact

## 【Contact】

Applicable Cable Size		Insulation O.D. (mm)	Contact Size	Package Style	Part Number		Contact Quantity (pcs)
AWG	mm <sup>2</sup>				Receptacle Contact	Tab Contact	
28	0.08	0.88 ~ 1.50	S	Reel	DK-2RECSST1-6000	DK-2TABSST1-6000	6,000
26	0.12				DK-2RECSLP1-100	DK-2TABSLP1-100	100
24	0.20			1.11 ~ 2.0	M	Reel	DK-2RECMST1-6000
20	0.50	DK-2RECMLP1-100	DK-2TABMLP1-100				100
18	0.80						

## 【Premating Contact】

Applicable Cable Size		Insulation O.D. (mm)	Contact Size	Package Style	Part Number		Contact Quantity (pcs)
AWG	mm <sup>2</sup>				Receptacle Contact	Tab Contact	
28	0.08	0.88 ~ 1.50	S	Reel	DK-2RECSST1-E-6000	DK-2TABSST1-E-6000	6,000
26	0.12				DK-2RECSLP1-E-100	DK-2TABSLP1-E-100	100
24	0.20			1.11 ~ 2.0	M	Reel	DK-2RECMST1-E-6000
20	0.50	DK-2RECMLP1-E-100	DK-2TABMLP1-E-100				100
18	0.80						

## DK-2RECSST1-E-6000

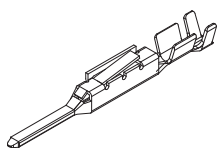
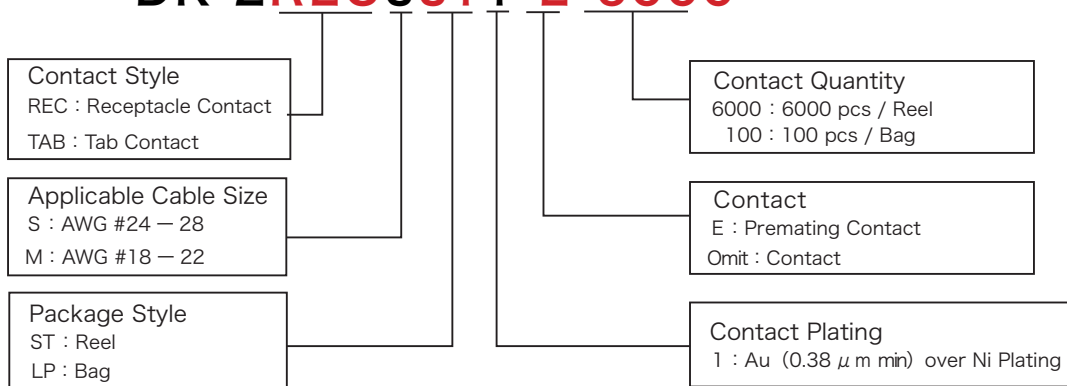

■ Tab Contact

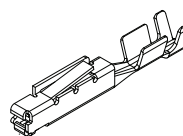

■ Receptacle Contact