

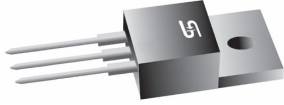

# MBR1535CT THRU MBR15100CT

## 15.0 AMPS. Schottky Barrier Rectifiers



Voltage Range  
35 to 100 Volts  
Current  
15.0 Amperes

### Features

- ✧ Plastic material used carries Underwriters Laboratory Classifications 94V-0
- ✧ Metal silicon junction, majority carrier conduction
- ✧ Low power loss, high efficiency
- ✧ High current capability, low forward voltage drop
- ✧ High surge capability
- ✧ For use in low voltage, high frequency inverters, free wheeling, and polarity protection applications
- ✧ Guardring for transient protection
- ✧ High temperature soldering guaranteed: 260°C/10 seconds, 0.25"(6.35mm) from case

### Mechanical Data

- ✧ Cases: JEDEC TO-220 molded plastic body
- ✧ Terminals: Leads solderable per MIL-STD-750, Method 2026
- ✧ Polarity: As marked
- ✧ Mounting position: Any
- ✧ Mounting torque: 5 in. - lbs. max
- ✧ Weight: 0.08 ounce, 2.24 grams

### TO-220

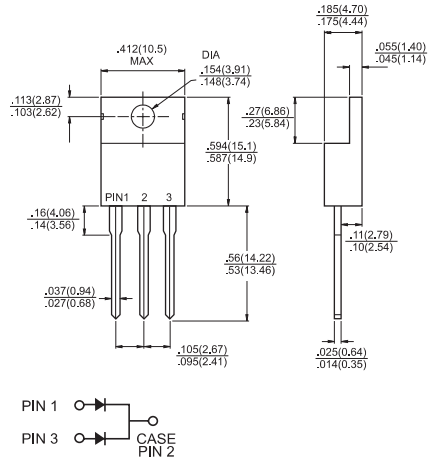

Dimensions in inches and (millimeters)

### Maximum Ratings and Electrical Characteristics

Rating at 25°C ambient temperature unless otherwise specified.

Single phase, half wave, 60 Hz, resistive or inductive load.

For capacitive load, derate current by 20%

Type Number	Symbol	MBR 1535CT	MBR 1545CT	MBR 1550CT	MBR 1560CT	MBR 1590CT	MBR 15100CT	Units	
Maximum Recurrent Peak Reverse Voltage	$V_{RRM}$	35	45	50	60	90	100	V	
Maximum RMS Voltage	$V_{RMS}$	24	31	35	42	63	70	V	
Maximum DC Blocking Voltage	$V_{DC}$	35	45	50	60	90	100	V	
Maximum Average Forward Rectified Current at $T_C=105^\circ\text{C}$	$I_{(AV)}$	15						A	
Peak Repetitive Forward Current (Rated $V_R$ , Square Wave, 20KHz) at $T_C=105^\circ\text{C}$	$I_{FRM}$	15.0						A	
Peak Forward Surge Current, 8.3 ms Single Half Sine-wave Superimposed on Rated Load (JEDEC method)	$I_{FSM}$	150						A	
Peak Repetitive Reverse Surge Current (Note 1)	$I_{RRM}$	1.0		0.5			A		
Maximum Instantaneous Forward Voltage at (Note 2) $I_F=7.5\text{A}, T_C=25^\circ\text{C}$ $I_F=7.5\text{A}, T_C=125^\circ\text{C}$ $I_F=15\text{A}, T_C=25^\circ\text{C}$ $I_F=15\text{A}, T_C=125^\circ\text{C}$	$V_F$	0.57	0.84	0.72	0.75	0.65	0.92	0.82	V
Maximum Instantaneous Reverse Current @ $T_C=25^\circ\text{C}$ at Rated DC Blocking Voltage (Note 2) @ $T_C=125^\circ\text{C}$	$I_R$	0.1	15.0	1.0	50.0	0.1	-	mA mA	
Voltage Rate of Change (Rated $V_R$ )	$dV/dt$	1,000						V/ $\mu\text{s}$	
Maximum Thermal Resistance Per Leg (Note 3)	$R_{\theta JA}$ $R_{\theta JC}$	60.0 3.0						$^\circ\text{C}/\text{W}$	
Operating Junction Temperature Range	$T_J$	-65 to +150						$^\circ\text{C}$	
Storage Temperature Range	$T_{STG}$	-65 to +175						$^\circ\text{C}$	

Notes: 1. 2.0us Pulse Width,  $f=1.0\text{KHz}$

2. Pulse Test: 300us Pulse Width, 1% Duty Cycle

3. Thermal Resistance from Junction to Case and Thermal Resistance from Junction to Ambient

## RATINGS AND CHARACTERISTIC CURVES (MBR1535CT THRU MBR15100CT)

FIG.1- FORWARD CURRENT DERATING CURVE

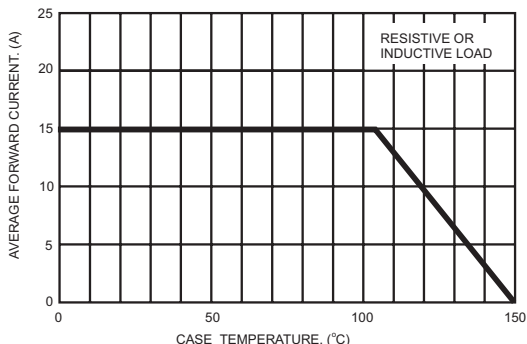

FIG.2- MAXIMUM NON-REPETITIVE FORWARD SURGE CURRENT PER LEG

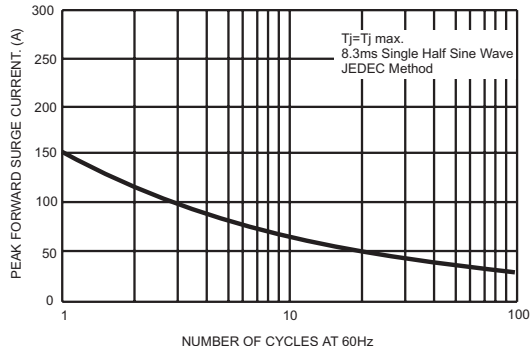

FIG.3- TYPICAL INSTANTANEOUS FORWARD CHARACTERISTICS PER LEG

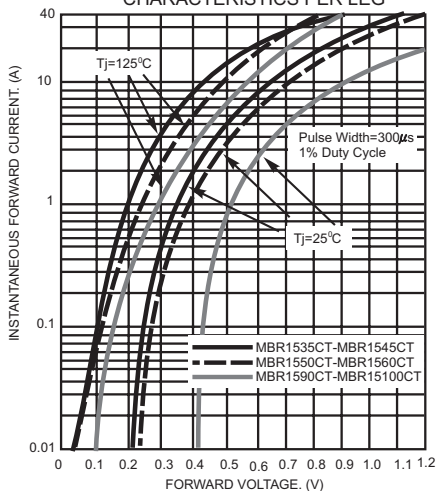

FIG.4- TYPICAL REVERSE CHARACTERISTICS PER LEG

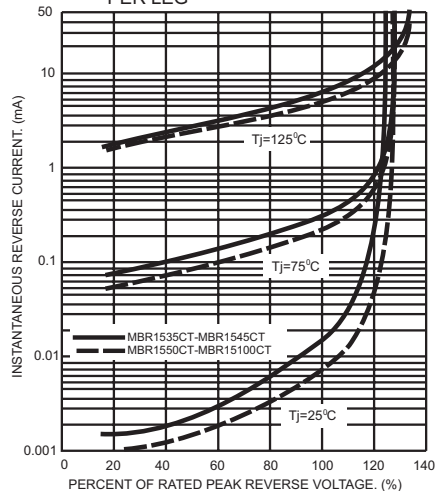

FIG.5- TYPICAL JUNCTION CAPACITANCE PER LEG

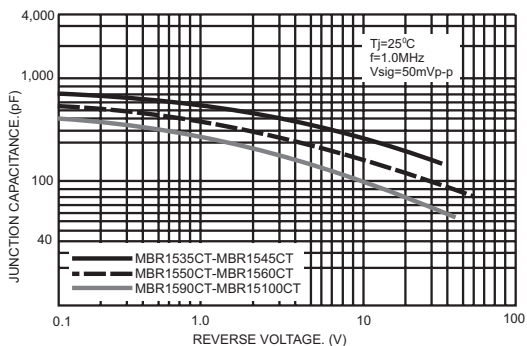

FIG.6- TYPICAL TRANSIENT THERMAL CHARACTERISTICS PER LEG

